



***Getting Started
with
OpenOffice.org 3.3***

Free eBook Edition

Copyright

This document is Copyright © 2005–2010 by its contributors as listed below. You may distribute it and/or modify it under the terms of either the GNU General Public License (<http://www.gnu.org/licenses/gpl.html>), version 3 or later, or the Creative Commons Attribution License (<http://creativecommons.org/licenses/by/3.0/>), version 3.0 or later.

Contributors

Jean Hollis Weber
Magnus Adielsson
Richard Barnes
Chris Bonde
Daniel Carrera
Richard Detwiler
Laurent Duperval
Regina Henschel
Richard Holt
Rachel Kartch
Jared Kobos
Peter Kupfer
Dan Lewis
Michel Pinguier
Carol Roberts
Hazel Russman
Robert Scott
Janet Swisher
Alex Thurgood
Claire Wood

Michele Zarri
Thomas Astleitner
Agnes Belzunce
Nicole Cairns
JiHui Choi
Alexander Noël Dunne
Spencer E. Harpe
Peter Hillier-Brook
John Kane
Stefan A. Keel
Michael Kotsarinis
Ian Laurenson
Alan Madden
Andrew Pitonyak
Iain Roberts
Gary Schnabl
Joe Sellman
Jim Taylor
Barbara M. Tobias
Linda Worthington

Feedback

Please direct any comments or suggestions about this document to:
authors@documentation.openoffice.org

Publication date and software version

Published 30 November 2010. Based on OpenOffice.org 3.3.

Free eBook Edition



You can download
an editable version of this document from
<http://oooauthors.org/english/userguide3/published/>

Contents

Chapter 1	
Introducing OpenOffice.org.....	9
What is OpenOffice.org?.....	10
The advantages of OpenOffice.org.....	11
Minimum requirements.....	12
How to get the software.....	12
How to install the software.....	13
Extensions and add-ons.....	13
How to get help.....	13
Starting OpenOffice.org.....	14
Parts of the main window.....	17
What are all these things called?.....	22
Starting a new document.....	23
Opening an existing document.....	23
Saving a document.....	24
Renaming and deleting files.....	25
Using the Open and Save As dialogs.....	25
Using the Navigator.....	26
Undoing and redoing changes.....	28
Closing a document.....	29
Closing OpenOffice.org.....	29
Using OpenOffice.org on a Mac.....	30
Chapter 2	
Setting up OpenOffice.org.....	31
Choosing options for all of OOo.....	32
Choosing options for loading and saving documents.....	46
Choosing language settings.....	51
Choosing Internet options.....	53
Controlling OOo's AutoCorrect functions.....	54
Chapter 3	
Using Styles and Templates.....	55
What is a template?.....	56
What are styles?.....	56
Applying styles.....	57
Modifying styles.....	59
Creating new (custom) styles.....	61
Copying and moving styles.....	62
Deleting styles.....	64
Using a template to create a document.....	65
Creating a template.....	66
Editing a template.....	68
Adding templates using the Extension Manager.....	69

Setting a default template.....	70
Associating a document with a different template.....	71
Organizing templates.....	72
Examples of style use.....	73
Chapter 4	
Getting Started with Writer.....	76
What is Writer?.....	77
The Writer interface.....	77
Changing document views.....	79
Moving quickly through a document.....	80
Working with documents.....	81
Working with text.....	82
Formatting text.....	90
Formatting pages.....	94
Adding comments to a document.....	98
Creating a table of contents.....	99
Creating indexes and bibliographies.....	100
Working with graphics.....	100
Printing.....	100
Using mail merge.....	100
Tracking changes to a document.....	101
Using fields.....	101
Linking to another part of a document.....	101
Using master documents.....	104
Creating fill-in forms.....	104
Chapter 5	
Getting Started with Calc.....	105
What is Calc?.....	106
Spreadsheets, sheets and cells.....	106
Parts of the main Calc window.....	107
Opening and saving CSV files.....	109
Navigating within spreadsheets.....	111
Selecting items in a sheet or spreadsheet.....	115
Working with columns and rows.....	117
Working with sheets.....	118
Viewing Calc.....	120
Entering data using the keyboard.....	123
Speeding up data entry.....	124
Sharing content between sheets.....	127
Validating cell contents.....	127
Editing data.....	128
Formatting data.....	129
Autoformatting cells and sheets.....	133
Formatting spreadsheets using themes.....	134

Using conditional formatting.....	134
Hiding and showing data.....	134
Sorting records.....	136
Printing.....	137
Chapter 6	
Getting Started with Impress.....	144
What is Impress?.....	145
Starting Impress.....	145
Parts of the main Impress window.....	145
Workspace views.....	149
Creating a new presentation.....	153
Formatting a presentation.....	156
Adding and formatting text.....	159
Adding pictures, tables, charts and media.....	163
Working with slide masters and styles.....	166
Adding comments to a presentation.....	171
Setting up the slide show.....	172
Running the slide show.....	173
Chapter 7	
Getting Started with Draw.....	174
What is Draw?.....	175
The Draw workspace.....	175
Choosing and defining colors.....	178
Positioning objects with snap functions.....	179
Positioning objects with guiding lines.....	181
The basic drawing shapes.....	182
Drawing geometric shapes.....	187
Selection modes.....	189
Selecting objects.....	190
Moving and dynamically adjusting an object's size.....	191
Editing objects.....	193
Using styles.....	195
Special effects.....	195
Combining multiple objects.....	198
Aids for positioning objects.....	199
Inserting and editing pictures.....	199
Working with 3D objects.....	199
Exporting graphics.....	199
Adding comments to a drawing.....	200
Chapter 8	
Getting Started with Base.....	201
Introduction.....	202
Planning a database.....	203
Creating a new database.....	204

Creating database tables.....	205
Defining relationships.....	213
Creating a database form.....	215
Accessing other data sources.....	229
Using data sources in OpenOffice.org.....	231
Entering data in a form.....	235
Creating queries.....	237
Creating reports.....	245
Chapter 9	
Getting Started with Math.....	253
What is Math?.....	254
Entering a formula.....	255
Customizations.....	260
Formula layout.....	262
Numbering equations.....	265
Chapter 10	
Printing, Exporting, and E-mailing.....	267
Introduction.....	268
Quick printing.....	268
Controlling printing.....	268
Exporting to PDF.....	277
Exporting to other formats.....	283
E-mailing documents.....	283
Digital signing of documents.....	287
Removing personal data.....	287
Chapter 11	
Graphics, the Gallery, and Fontwork.....	288
Introduction.....	289
Adding images to a document.....	289
Modifying and positioning graphics.....	293
Managing the OpenOffice.org Gallery.....	293
Creating an image map.....	296
Using OOO's drawing tools.....	297
Using Fontwork.....	300
Chapter 12	
Creating Web Pages.....	306
Introduction.....	307
Relative and absolute hyperlinks.....	307
Creating hyperlinks.....	308
Saving Writer documents as web pages.....	311
Creating web pages using a Wizard.....	312
Saving Calc spreadsheets as web pages.....	316
Saving Impress presentations as web pages.....	316
Saving Draw documents as web pages.....	320

Chapter 13	
Getting Started with Macros.....	321
Your first macros.....	322
Creating a macro.....	327
Sometimes the macro recorder fails.....	331
Macro organization.....	332
How to run a macro.....	337
Extensions.....	341
Writing macros without the recorder.....	341
Finding more information.....	342
Chapter 14	
Customizing OpenOffice.org.....	344
Introduction.....	345
Customizing menu content.....	345
Customizing toolbars.....	348
Assigning shortcut keys.....	352
Assigning macros to events.....	354
Adding functionality with extensions.....	354
Appendix A	
Keyboard Shortcuts.....	357
Introduction.....	358
General keyboard shortcuts.....	359
Defining keyboard shortcuts.....	361
Further reading.....	361
Appendix B	
Open Source, Open Standards, OpenDocument.....	362
Introduction.....	363
A short history of OpenOffice.org.....	363
The OpenOffice.org community.....	363
How is OpenOffice.org licensed?.....	363
What is “open source”?.....	364
What are “open standards”?.....	364
What is OpenDocument?.....	364
Frequently asked questions.....	365
File formats OOo can open.....	366
File formats OOo can save to.....	368
Exporting to other formats.....	369
Index.....	370



Chapter 1
Introducing
OpenOffice.org

What is OpenOffice.org?

OpenOffice.org (OOo) is both a *software product* and a *community of volunteers* who produce and support the software.

Note Because someone else owns the trademark *OpenOffice*, the correct name for both the open-source project and its software is *OpenOffice.org*.

The OpenOffice.org software is a freely available, full-featured office productivity suite. If you have used previous versions of OpenOffice.org, you might want to look over the new features lists at http://www.openoffice.org/dev_docs/features/3.0/, http://www.openoffice.org/dev_docs/features/3.1/, http://www.openoffice.org/dev_docs/features/3.2/, and http://www.openoffice.org/dev_docs/features/3.3/.

OOo's native file format is OpenDocument, an open standard format that is being adopted by governments worldwide as a required file format for publishing and accepting documents. OOo can also open and save documents in many other formats, including those used by several versions of Microsoft Office.

OOo includes the following components.

Writer (word processor)

Writer is a feature-rich tool for creating letters, books, reports, newsletters, brochures, and other documents. You can insert graphics and objects from other components into Writer documents. Writer can export files to HTML, XHTML, XML, Adobe's Portable Document Format (PDF), and several versions of Microsoft Word files. It also connects to your email client.

Calc (spreadsheet)

Calc has all of the advanced analysis, charting, and decision-making features expected from a high-end spreadsheet. It includes over 300 functions for financial, statistical, and mathematical operations, among others. The Scenario Manager provides "what if" analysis. Calc generates 2-D and 3-D charts, which can be integrated into other OOo documents. You can also open and work with Microsoft Excel workbooks and save them in Excel format. Calc can export spreadsheets to Adobe's PDF and to HTML.

Impress (presentations)

Impress provides all the common multimedia presentation tools, such as special effects, animation, and drawing tools. It is integrated with the advanced graphics capabilities of OOo's Draw and Math components. Slide shows can be further enhanced with Fontwork's special effects text, as well as sound and video clips. Impress is compatible with Microsoft's PowerPoint file format and can also save your work in numerous graphics formats, including Macromedia Flash (SWF).

Draw (vector graphics)

Draw is a vector drawing tool that can produce everything from simple diagrams or flowcharts to 3-D artwork. Its Smart Connectors feature allows you to define your

own connection points. You can use Draw to create drawings for use in any of OOo's other components, and you can create your own clip art and add it to the Gallery. Draw can import graphics from many common formats and save them in over 20 formats, including PNG, HTML, PDF, and Flash.

Base (database)

Base provides tools for day-to-day database work within a simple interface. It can create and edit forms, reports, queries, tables, views, and relations, so that managing a connected database is much the same as in other popular database applications. Base provides many new features, such as the ability to analyze and edit relationships from a diagram view. Base incorporates HSQLDB as its default relational database engine. It can also use dBASE, Microsoft Access, MySQL, or Oracle, or any ODBC-compliant or JDBC-compliant database. Base also provides support for a subset of ANSI-92 SQL.

Math (formula editor)

Math is OOo's formula or equation editor. You can use it to create complex equations that include symbols or characters not available in standard font sets. While it is most commonly used to create formulas in other documents, such as Writer and Impress files, Math can also work as a standalone tool. You can save formulas in the standard Mathematical Markup Language (MathML) format for inclusion in web pages and other documents not created by OOo.

The advantages of OpenOffice.org

Here are some of the advantages of OpenOffice.org over other office suites:

- **No licensing fees.** OOo is free for anyone to use and distribute at no cost. Many features that are available as extra cost add-ins in other office suites (like PDF export) are free with OOo. There are no hidden charges now or in the future.
- **Open source.** You can distribute, copy, and modify the software as much as you wish, in accordance with either of OOo's Open Source licenses.
- **Cross-platform.** OOo3 runs on several hardware architectures and under multiple operating systems, such as Microsoft Windows, Mac OS X, Linux, and Solaris.
- **Extensive language support.** OOo's user interface is available in over 40 languages, and the OOo project provides spelling, hyphenation, and thesaurus dictionaries in over 70 languages and dialects. OOo also provides support for both Complex Text Layout (CTL) and Right to Left (RTL) layout languages (such as Urdu, Hebrew, and Arabic).
- **Consistent user interface.** All the components have a similar "look and feel," making them easy to use and master.
- **Integration.** The components of OpenOffice.org are well integrated with one another.
 - All the components share a common spelling checker and other tools, which are used consistently across the suite. For example, the drawing tools available in Writer are also found in Calc, with similar but enhanced versions in Impress and Draw.

- You do not need to know which application was used to create a particular file. For example, you can open a Draw file from Writer.
- **Granularity.** Usually, if you change an option, it affects all components. However, OOo options can be set at a component level or even document level.
- **File compatibility.** In addition to its native OpenDocument formats, OOo includes PDF and Flash export capabilities, as well as support for opening and saving files in many common formats including Microsoft Office, HTML, XML, WordPerfect, and Lotus 1-2-3 formats. New in OOo3 (using an extension): the ability to import and edit some PDF files.
- **No vendor lock-in.** OOo3 uses OpenDocument, an XML (eXtensible Markup Language) file format developed as an industry standard by OASIS (Organization for the Advancement of Structured Information Standards). These files can easily be unzipped and read by any text editor, and their framework is open and published.
- **You have a voice.** Enhancements, software fixes, and release dates are community-driven. You can join the community and affect the course of the product you use.

You can read more about OpenOffice.org, its mission, history, licensing, and other organizational information on the OpenOffice.org website, <http://www.openoffice.org/>.

Minimum requirements

OpenOffice.org 3.x requires one of the following operating systems:

- **Microsoft Windows** 2000 (Service Pack 2 or higher), XP, Vista, or 7
- **GNU/Linux** Kernel version 2.4 and glibc 2.3.2 or higher (starting with OOo 3.3 glibc2 version 2.5 or higher is required)
- **Mac OS X** 10.4 (Tiger) or higher; Intel Processor
- **Solaris** 10 OS or higher

Some OpenOffice.org features (wizards and the HSQLDB database engine) require that the Java Runtime Environment (JRE) 1.5.x or higher be installed on your computer. Although OOo will work without Java support, some features will not be available. You can download OOo for some operating systems with or without JRE included. If you have a slow machine and do not often need the features requiring JRE, you can try to disable it to speed up the loading of the program.

For a more detailed (and up-to-date) listing of requirements, see the OpenOffice.org website, http://www.openoffice.org/dev_docs/source/sys_reqs_30.html.

How to get the software

Many new computers come with OpenOffice.org installed. In addition, most Linux distributions, such as Ubuntu, include OpenOffice.org.

If you need to install it yourself, you can download the installation package from the project's home page or by using a Peer to Peer client such as BitTorrent. Instructions for BitTorrent are here: <http://distribution.openoffice.org/p2p/>.

The installation package is approximately 150MB. People with slow Internet connections may prefer to purchase a copy on a CD or DVD from a third-party distributor. The project maintains a list of distributors, but the distributors are not

connected with, nor endorsed by, OpenOffice.org.
<http://distribution.openoffice.org/cdrom/sellers.html>

How to install the software

Information on installing and setting up OpenOffice.org on the various supported operating systems is given here:

<http://download.openoffice.org/common/instructions.html>.

You can also download the more detailed *Installation Guide* from

<http://wiki.services.openoffice.org/wiki/Documentation>.

Extensions and add-ons

Extensions and add-ons to enhance OpenOffice.org are collected in the official extensions repository, <http://extensions.services.openoffice.org/>. Most are free, but some are not. See Chapter 14 (Customizing OpenOffice.org) for more information.

How to get help

This book, the other OOO user guides, the built-in Help system, and user support systems assume that you are familiar with your computer and basic functions such as starting a program, opening and saving files.

Help system

OOo comes with an extensive Help system. This is your first line of support for using OOO.

To display the full Help system, press *F1* or select **OpenOffice.org Help** from the Help menu. In addition, you can choose whether to activate Tips, Extended tips, and the Help Agent (using **Tools > Options > OpenOffice.org > General**).

If Tips are enabled, place the mouse pointer over any of the icons to see a small box (“tooltip”) with a brief explanation of the icon’s function. For a more detailed explanation, select **Help > What's This?** and hold the pointer over the icon.

Free online support

The OpenOffice.org community not only develops software, but provides free, volunteer-based support. Users of OOO can get comprehensive online support from community venues such as newsgroups, forums, or mailing lists. There are also numerous websites run by users that offer free tips and tutorials.

Free OpenOffice.org support

Users Mailing List

Free community support provided by a network of hundreds of experienced users. You must be subscribed to post messages. To subscribe, send a blank email to users-subscribe@openoffice.org
List archives are here:
<http://www.openoffice.org/servlets/SummarizeList?listName=users>

Free OpenOffice.org support

Documentation Project	Templates, user guides, how-tos, and other documentation. http://documentation.openoffice.org/ See also the Documentation wiki, http://wiki.services.openoffice.org/wiki/Documentation
Native Language Project	Information, resources, and mail lists in your language. http://projects.openoffice.org/native-lang.html
Mac Support	Support for installing and using OOO on Mac OS X. http://porting.openoffice.org/mac/index.html
OpenOffice.org Community Forum	Extensive discussion forum for OpenOffice.org issues from setup to advanced programming features. http://user.services.openoffice.org/en/forum/
OpenOffice.org Macro Information	Andrew Pitonyak, the author of <i>OpenOffice.org Macros Explained</i> , maintains this site, which provides extensive documentation on OOO's macro capability. Many good referral links are also provided: http://www.pitonyak.org/oo.php

Read more about the support options for OOO at <http://support.openoffice.org/index.html>

Paid support and training

Alternatively, you can pay for support services. Service contracts can be purchased from a vendor or consulting firm specializing in OpenOffice.org.

A list of independent [consultants](#) and the services they offer, listed alphabetically by region and then by country, is provided on the OpenOffice.org website, <http://bizdev.openoffice.org/consultants.html>.

Starting OpenOffice.org

The most common way to launch any component of OOO is by using the system menu, the standard menu from which most applications are started. On Windows, it is called the Start menu. On GNOME, it is called the Applications menu. On KDE it is identified by the KDE logo. On Mac OS X, it is the Applications menu.

When OOO was installed on your computer, in most cases a menu entry for each component was added to your system menu. (If you are using a Mac, see note below.) The exact name and location of these menu entries depend on the operating system and graphical user interface.

Note for Mac users

You should see the OpenOffice.org icon in the Applications folder. When you double-click this icon, OpenOffice.org opens at the Start Center (Figure 10).

Starting from an existing document

You can start OOO by double-clicking the filename of an OOO document in a file manager such as Windows Explorer. The appropriate component of OOO will start and the document will be loaded.

Note for Windows users

If you have associated Microsoft Office file types with OOo, then when you double-click on a *.doc (Word) file, it opens in Writer; *.xls (Excel) files open in Calc, and *.ppt (PowerPoint) files open in Impress.

If you did not associate the file types, then when you double-click on a Microsoft Word document, it opens in Microsoft Word (if Word is installed on your computer), Excel files open in Excel, and PowerPoint files open in PowerPoint.

You can use another method to open Microsoft Office files in OOo and save in those formats from OOo. See “Opening an existing document” on page 23 for more information.

Using the Quickstarter under Windows

The Quickstarter is an icon that is placed in the Windows system tray during system startup. It indicates that OpenOffice.org has been loaded and is ready to use. (The Quickstarter loads library *.DLL files required by OOo, thus shortening the startup time for OOo components by about half.) If the Quickstarter is disabled, see “Reactivating the Quickstarter” if you want to enable it.

Using the Quickstarter icon

Right-click the **Quickstarter** icon in the system tray to open a pop-up menu (Figure 1) from which you can open a new document, open the Templates and Documents dialog, or choose an existing document to open. You can also double-click the **Quickstarter** icon to display the Templates and Documents dialog.

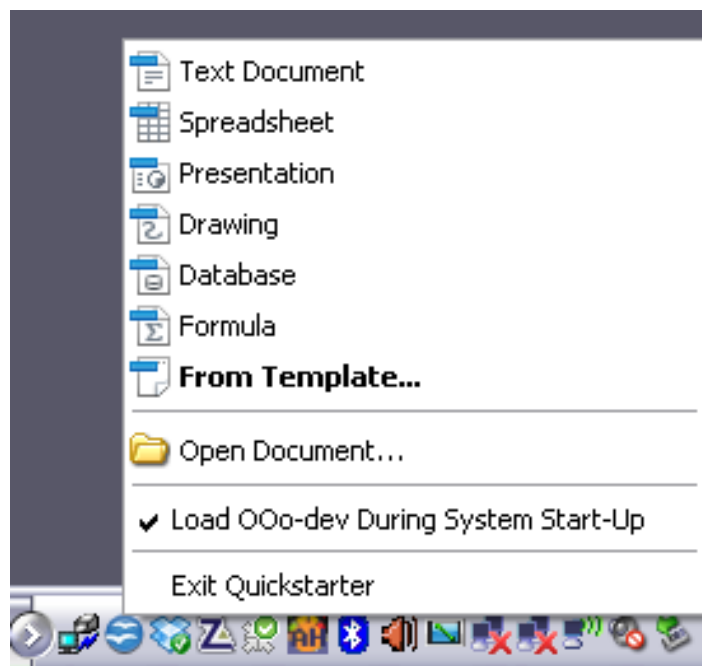

Figure 1: Quickstarter pop-up menu

Disabling the Quickstarter

To close the Quickstarter, right-click on the icon in the system tray, and then click **Exit Quickstarter** on the pop-up menu. The next time the computer is restarted, the Quickstarter will be loaded again.

To prevent OpenOffice.org from loading during system startup, deselect the **Load OpenOffice.org during system start-up** item on the pop-up menu. You might want to do this if your computer has insufficient memory, for example.

Reactivating the Quickstarter

If the Quickstarter has been disabled, you can reactivate it by selecting the **Load OpenOffice.org during system start-up** checkbox in **Tools > Options > OpenOffice.org > Memory**.

Using the Quickstarter in Linux

Some installations of OpenOffice.org under Linux have a Quickstarter that looks and acts like the one described above for Windows (the checkbox on the Memory page is labeled **Enable systray quickstarter**).

Preloading OOO under Linux/KDE

In Linux/KDE, you can use KDocker to have OOO loaded and ready for use at startup. KDocker is not part of OOO; it is a generic “systray app docker” that is helpful if you open OOO often.

Starting from the command line

You may want to start OOO from the command line (using the keyboard instead of the mouse). By using the command line, you have more control over what happens when OOO is started. For example, using the command line, you can tell Writer to load a document and print it immediately, or to start without showing the splash screen.

Note Most users will never need to do this.

There is more than one way to start OOO from the command line, depending on whether you have installed a customized version or the standard download from the OOO website.

If you installed using the download on the OOO website, you can start Writer by typing at the command line:

```
soffice -writer / ooffice -writer
```

or

```
owriter
```

Writer will start and create a new document. Likewise, you can start other OOO components from the command line; in Windows:

Type of document	Component	Command-line option
Text	Writer	-writer
Spreadsheet	Calc	-calc
Drawing	Draw	-draw
Presentation	Impress	-impress
Formula	Math	-math
Database	Base	-base
Web page	Writer	-web

To see a list of options you can use when starting Writer at the command line in Windows, type:

```
soffice -?
```

Below is a list of some of the more popular options.

Option	Description
-help	Get a complete list of options.
-nologo	Do not show the startup screen.
-show <odp-file>	Start presentation immediately.
-view <documents ...>	Open documents in viewer (read-only) mode.
-minimized	Start OOo minimized.
-norestore	Suppress restart/restore after fatal errors.
-invisible	No startup screen, no default document, and no UI. This is useful for third-party applications that use functionality provided by OOo.

If you have a customized version of OOo (such as the one provided by Linux Mandrake, Gentoo, Debian and Ubuntu), you can start Writer by typing at the command line: `oowriter`

Although the command syntax differs, the effect is identical: it starts OOo with an empty Writer document.

Parts of the main window

The main window is similar in each component of OOo, although some details vary. See the chapters in this book about Writer, Calc, Draw, and Impress for descriptions of those details.

Common features include the menu bar, the standard toolbar, and the formatting toolbar at the top of the window and the status bar at the bottom.

Menu bar

The *Menu bar* is located across the top of the OOo window, just below the Title bar. When you choose one of the menus listed below, a submenu drops down to show commands.

- **File** contains commands that apply to the entire document such as Open, Save, and Export as PDF.
- **Edit** contains commands for editing the document such as Undo: xxx (where xxx is the command to undo) and Find & Replace. It also contains commands to cut, copy, and paste selected parts of your document.
- **View** contains commands for controlling the display of the document such as Zoom and Web Layout.
- **Insert** contains commands for inserting elements into your document such as Header, Footer, and Picture.
- **Format** contains commands, such as Styles and Formatting and AutoCorrect, for formatting the layout of your document.
- **Table** shows all commands to insert and edit a table in a text document.
- **Tools** contains functions such as Spelling and Grammar, Customize, and Options.
- **Window** contains commands for the display window.
- **Help** contains links to the OpenOffice.org Help file, What's This?, and information about the program. See "How to get help" on page 13.

Toolbars

OOo has several types of toolbars: docked, floating, and tear-off. Docked toolbars can be moved to different locations or made to float, and floating toolbars can be docked.

The top docked toolbar (default position) is called the *Standard toolbar*. The Standard toolbar is consistent across the OpenOffice.org applications.

The second toolbar across the top (default location) is the *Formatting toolbar*. It is a context-sensitive bar that shows the relevant tools in response to the cursor's current position or selection. For example, when the cursor is on a graphic, the Formatting bar provides tools for formatting graphics; when the cursor is in text, the tools are for formatting text.

Displaying or hiding toolbars

To display or hide toolbars, choose **View > Toolbars**, then click on the name of a toolbar in the list. An active toolbar shows a checkmark beside its name. Tear-off toolbars are not listed in the View menu.

Submenus and tear-off toolbars

Toolbar icons with a small triangle to the right will display *submenus*, *tear-off toolbars*, and other ways of selecting things, depending on the icon.

Figure 2 shows a tear-off toolbar from the Drawing toolbar.

The tear-off toolbars can be floating or docked along an edge of the screen or in one of the existing toolbar areas. To move a floating tear-off toolbar, drag it by the title bar. See "Moving toolbars" below.

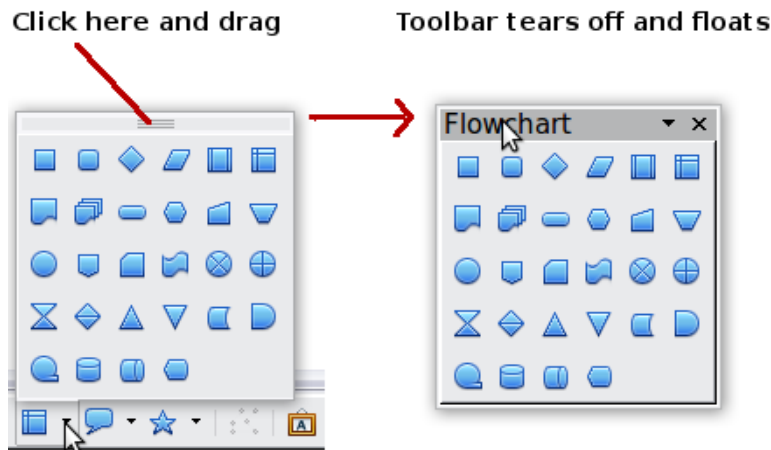

Figure 2: Example of a tear-off toolbar

Moving toolbars

To move a docked toolbar, place the mouse pointer over the toolbar handle (the small vertical bar to the left of the toolbar), hold down the left mouse button, drag the toolbar to the new location, and then release the mouse button (Figure 3). To move a floating toolbar, click on its title bar and drag it to a new location (Figure 4).

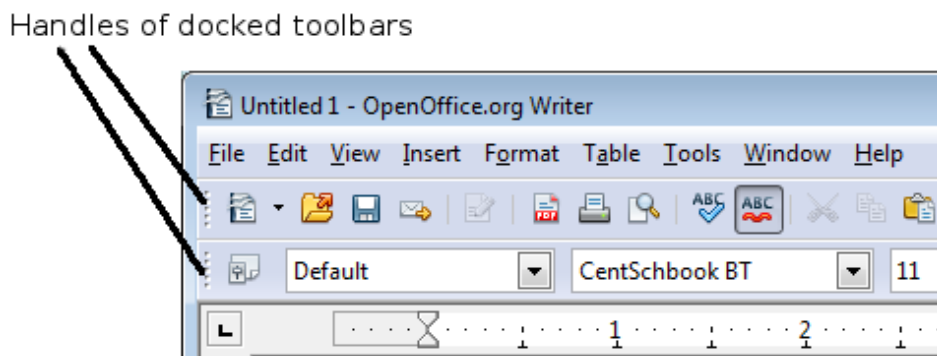

Figure 3: Moving a docked toolbar

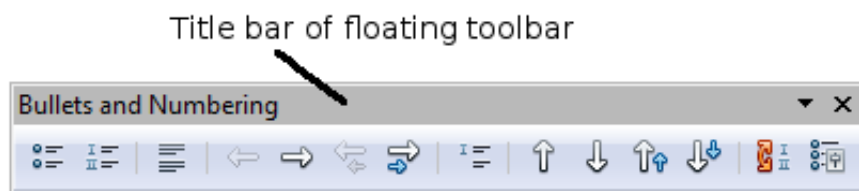

Figure 4: Moving a floating toolbar

Floating toolbars

OOo includes several additional context-sensitive toolbars, whose defaults appear as floating toolbars in response to the cursor's current position or selection. For example, when the cursor is in a table, a floating *Table* toolbar appears, and when the cursor is in a numbered or bullet list, the *Bullets and Numbering* toolbar appears. You can dock these toolbars to the top, bottom, or side of the window, if you wish (see "Moving toolbars" above).

Docking/floating windows and toolbars

Toolbars and some windows, such as the Navigator and the Styles and Formatting window, are dockable. You can move, resize, or dock them to an edge.

To dock a window or toolbar, hold down the *Control* key and double-click on the frame of the floating window (or in a vacant area near the icons at the top of the floating window) to dock it in its last position.

To undock a window, hold down the *Control* key and double-click on the frame (or a vacant area near the icons at the top) of the docked window.

Customizing toolbars

You can customize toolbars in several ways, including choosing which icons are visible and locking the position of a docked toolbar. You can also add icons and create new toolbars, as described in Chapter 14.

To access a toolbar's customization options, use the down-arrow at the end of the toolbar or on its title bar.

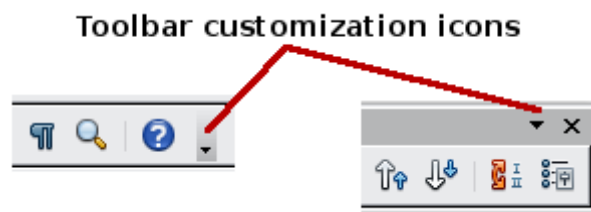

Figure 5: Customizing toolbars

To show or hide icons defined for the selected toolbar, choose **Visible Buttons** from the drop-down menu. Visible icons are indicated by an outline around the icon. Click on icons to select or deselect them.

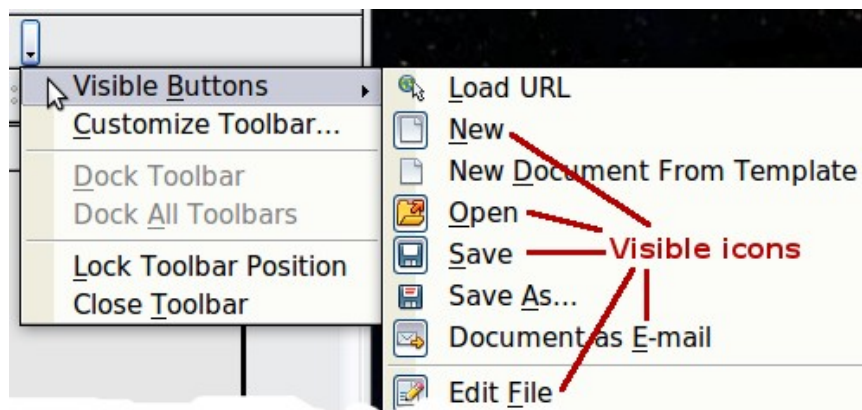

Figure 6: Selection of visible toolbar icons

Right-click (context) menus

You can quickly access many menu functions by right-clicking on a paragraph, graphics, or other object. A context menu will pop up. Often the context menu is the fastest and an easier way to reach a function. If you are not sure where a function is located in the menus or toolbars, you can often find it by right-clicking.

Status bar

The status bar is located at the bottom of the workspace. It provides information about the document and convenient ways to quickly change some features. It is similar in Writer, Calc, Impress, and Draw, although each component includes some component-specific items.

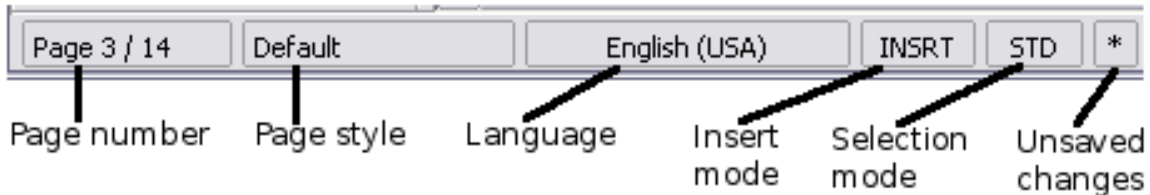

Figure 7: Left end of status bar in Writer

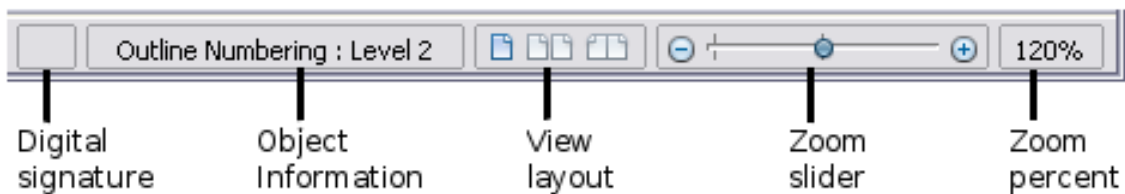

Figure 8: Right end of status bar in Writer

Common status bar items are described below.

Page, sheet, or slide number

Shows the current page, sheet, or slide number and the total number of pages, sheets, or slides in the document. Double-click on this field to open the Navigator. Other uses of this field depend on the component.

Page style or slide design

Shows the current page style or slide design. To edit the current page style or slide design, double-click on this field.

Unsaved changes

An asterisk (*) appears here if changes to the document have not been saved.

Digital signature

If the document has been digitally signed, an icon  shows here. You can double-click the icon to view the certificate.

Object information

Displays information relevant to the cursor's position or the selected element of the document. Double-clicking in this area usually opens a relevant dialog.

Zoom slider and percent

To change the view magnification, drag the Zoom slider, or click on the + and - signs, or right-click on the zoom level percent to pop up a list of magnification values from which to choose.

Double-clicking on the zoom level percent opens the **Zoom & View Layout** dialog.

What are all these things called?

The terms used in OpenOffice.org for most parts of the *user interface* (the parts of the program you see and use, in contrast to the behind-the-scenes code that actually makes it work) are the same as for most other programs.

A *dialog* is a special type of window. Its purpose is to inform you of something, or request input from you, or both. It provides controls for you to use to specify how to carry out an action. The technical names for common controls are shown in Figure 9; not shown is the list box (from which you select an item). In most cases we do not use the technical terms in this book, but it is useful to know them because the Help and other sources of information often use them.

In most cases, you can interact only with the dialog (not the document itself) as long as the dialog remains open. When you close the dialog after use (usually, clicking **OK** or another button saves your changes and closes the dialog), then you can again work with your document.

Some dialogs can be left open as you work, so you can switch back and forth between the dialog and your document. An example of this type is the Find & Replace dialog.

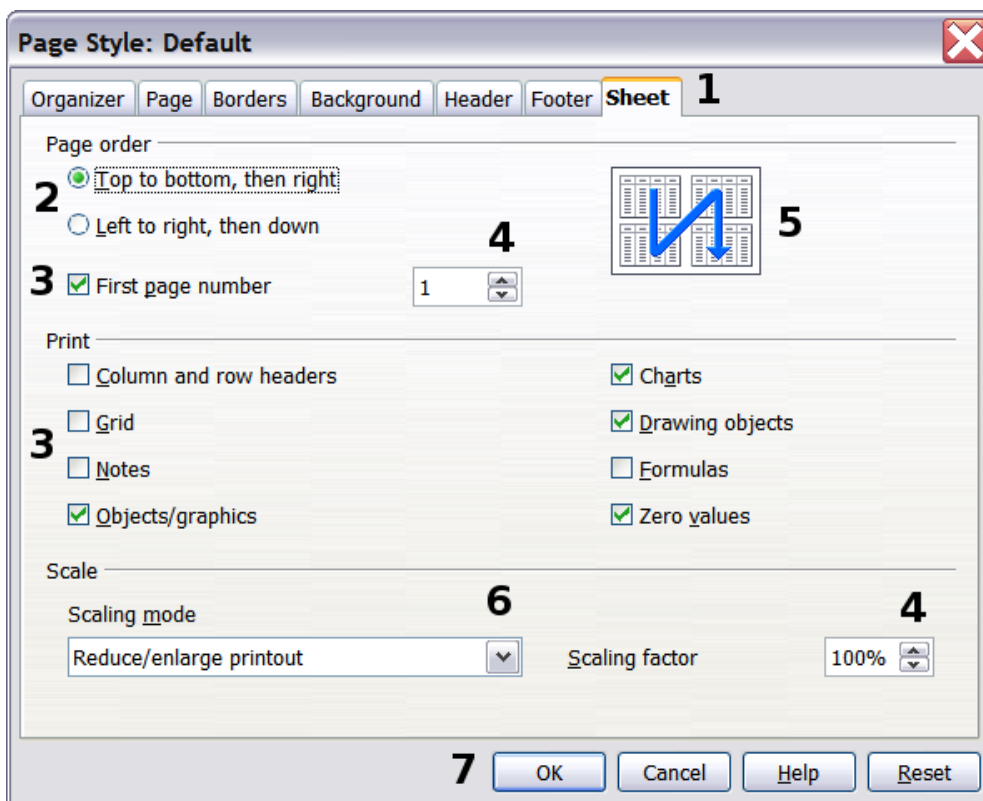

*Figure 9: Dialog showing common controls:
1=Tabbed page (not strictly speaking a control)
2=Radio buttons (only one can be selected at a time)
3=Checkbox (more than one can be selected at a time)
4=Spin box (click the up and down arrows to change the number shown in the text box next to it, or type in the text box)
5=Thumbnail or preview
6=Drop-down list from which to select an item
7=Push buttons*

Starting a new document

You can start a new, blank document in OOO in several ways.

When OOO is open but no document is open (for example if you close all the open documents but leave the program running), the Start Center is shown. Click one of the icons to open a new document of that type, or click the Templates icon to start a new document using a template.

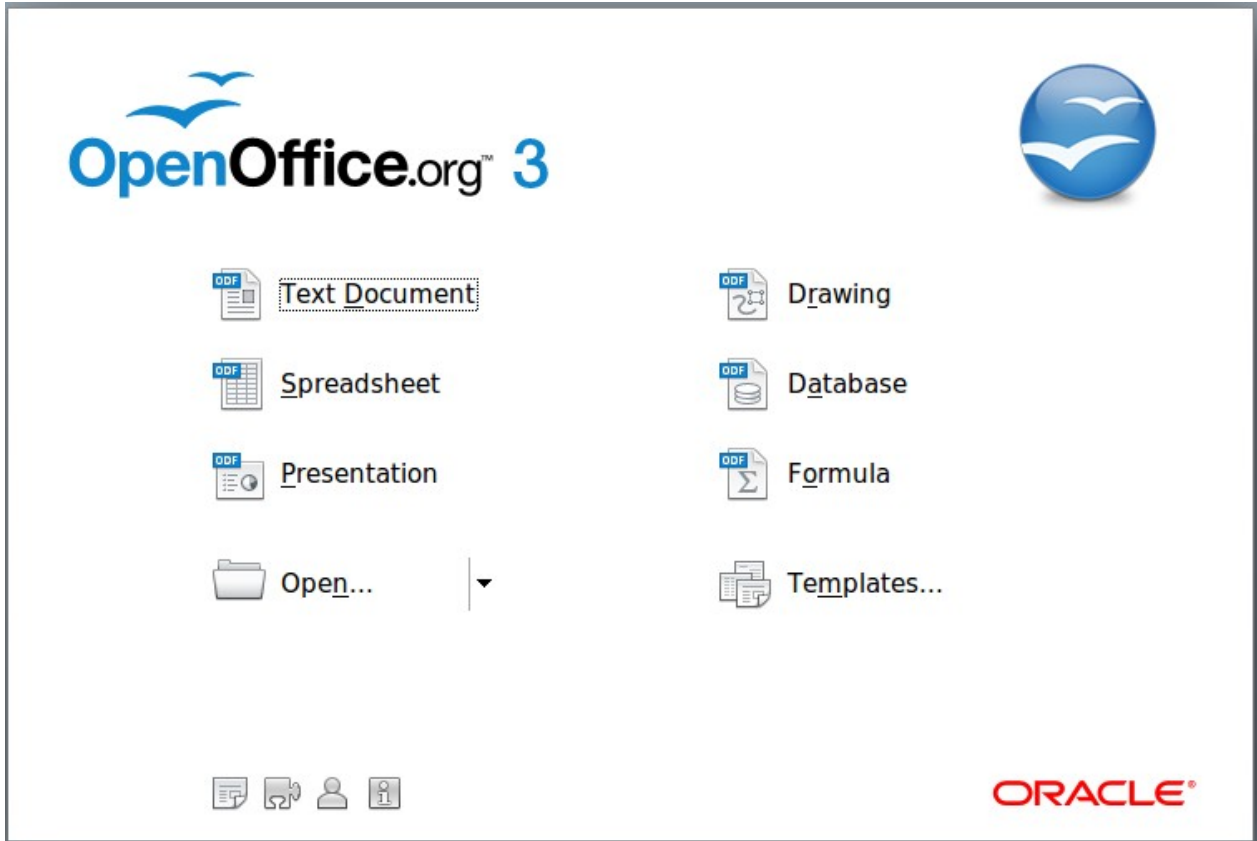

Figure 10: OpenOffice.org Start Center

You can also start a new document in one of the following ways.

- Use **File > New** and choose the type of document.
- Use the arrow next to the **New** button on the main toolbar. From the drop-down menu, select the type of document to be created.
- Press *Control+N* on the keyboard.
- Use **File > Wizards** for some special types of documents.

If a document is already open in OOO, the new document opens in a new window.

Opening an existing document

When no document is open, the Start Center provides an icon for opening an existing document or choosing from a list of recently-edited documents.

Open a file browser



Open a list of recently edited documents

You can also open an existing document in one of the following ways.

- Choose **File > Open...**
- Click the **Open** button on the main toolbar.
- Press *Control+O* on the keyboard.

In each case, the Open dialog appears. Select the file you want, and then click **Open**. If a document is already open in OOO, the second document opens in a new window.

In the Open dialog, you can reduce the list of files by selecting the type of file you are looking for. For example, if you choose **Text documents** as the file type, you will only see documents Writer can open (including .odt, .doc, .txt); if you choose **Spreadsheets**, you will see .ods, .xls, and other files that Calc opens.

You can also open an existing document that is in an OpenDocument format by double-clicking on the file's icon on the desktop or in a file manager such as Windows Explorer.

If you have associated Microsoft Office file formats with OOO, you can also open these files by double-clicking on them.

Note

Under Microsoft Windows you can use either the OOO Open and Save As dialogs or the ones provided by Microsoft Windows. See "Using the Open and Save As dialogs" on page 25.

Saving a document

To save a new document, do one of the following:

- Press *Control+S*.
- Choose **File > Save** from the menu bar.
- Click the **Save** button on the main toolbar.

When the Save As dialog appears, enter the file name, verify the file type (if applicable), and click **Save**.

To save an open document with the current file name, choose **File > Save**. This will overwrite the last saved state of the file.

Password protection

To protect an entire document from being viewable without a password, use the option on the Save As dialog to enter a password. This option is only available for files saved in OpenDocument formats or the older OpenOffice.org 1.x formats.

- 1) On the Save As dialog, select the **Save with password** option, and then click **Save**. You will receive a prompt (Figure 11).

- 2) Type the same password in both fields, and then click **OK**. If the passwords match, the document is saved password protected. If the passwords do not match, you receive the prompt to enter the password again.

Caution

OOo uses a very strong encryption mechanism that makes it almost impossible to recover the contents of a document in case you lose the password.



Figure 11: Entering a password for a document

Saving a document automatically

You can choose to have OpenOffice.org save files for you automatically. Automatic saving, like manual saving, overwrites the last saved state of the file. To set up automatic file saving:

- 1) Choose **Tools > Options... > Load/Save > General**.
- 2) Mark **Save AutoRecovery information every**, and set the time interval.

Renaming and deleting files

You can rename or delete files within the OOo dialogs, just as you can in your usual file manager. However, you cannot copy or paste files within the dialogs.

Using the Open and Save As dialogs

You can choose whether to use the OpenOffice.org Open and Save As dialogs or the ones provided by your operating system.

To view or change which type of dialog OpenOffice.org uses:

- 1) Choose **Tools > Options > OpenOffice.org > General**.
- 2) Select the **Use OpenOffice.org dialogs** option.

This section discusses the OpenOffice.org Open and Save As dialogs. Figure 12 shows the Save As dialog; the Open dialog is similar.

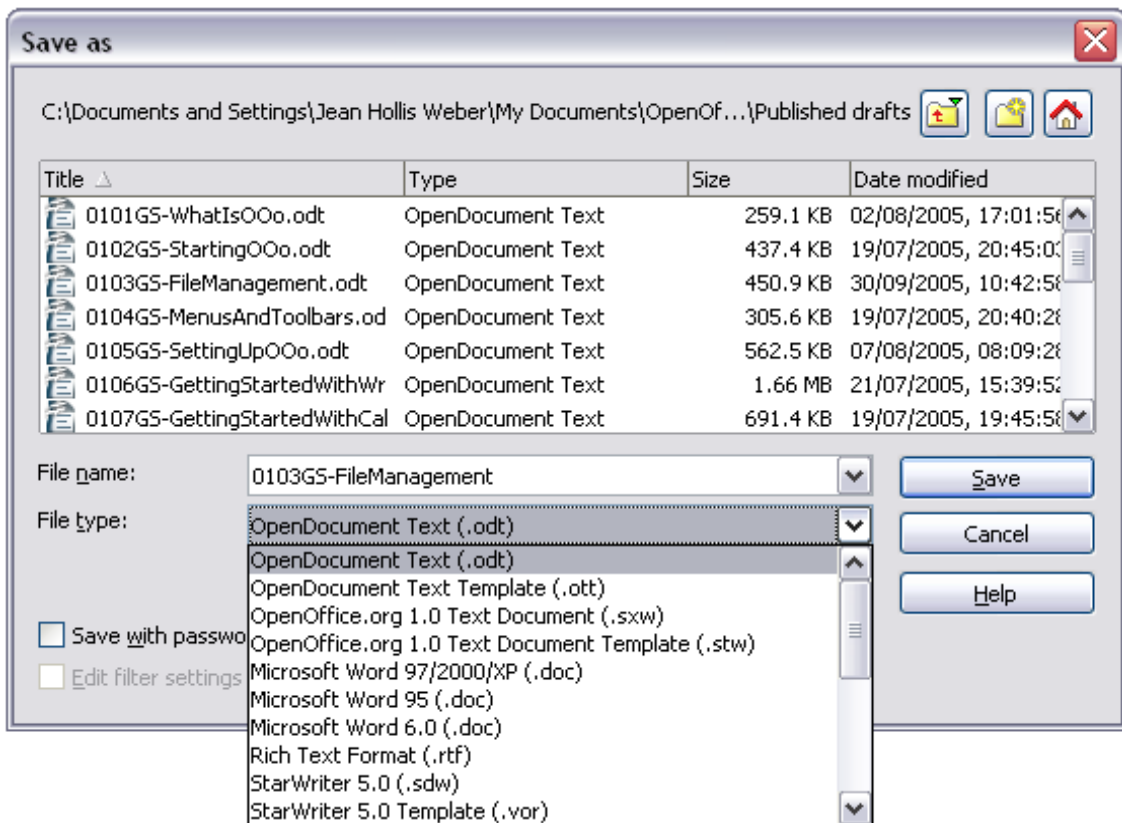

Figure 12: The OpenOffice.org Save As dialog

The three buttons in the top right of the OOo Open and Save As dialogs are, from left to right:

- **Go Up One Level** in the folder (directory) hierarchy. Click and hold this button for a second to drop down a list of higher level folders; to go to one of the folders on the list, move the mouse pointer over its name and release the mouse button.
- **Create New Folder.**
- **Default Directory.**

For OOo documents that have been saved with more than one version, use the **Version** drop-down to select which version you wish to open in read-only mode. For Microsoft Office documents, only the current version can be opened.

Use the **File type** field to specify the type of file to be opened or the format of the file to be saved.

The **Read-only** option on the Open dialog opens the file for reading and printing only. Consequently, most of the toolbars disappear, and most menu options are disabled. An **Edit File** button is displayed on the Standard toolbar to open the file for editing.

You can open files from the Web by typing a URL in the **File name** field on the Open dialog.

Using the Navigator

The Navigator lists objects contained in a document, collected into categories. For example, in Writer it shows Headings, Tables, Text frames, Comments, Graphics, Bookmarks, and other items, as shown in Figure 13. In Calc it shows Sheets, Range

Names, Database Ranges, Graphics, Drawing Objects, and other items. In Impress and Draw it shows Slides, Pictures, and other items.

To open the Navigator, click its icon  on the Standard toolbar, or press *F5*, or choose **View > Navigator** on the menu bar.

You can dock the Navigator to either side of the main OOo window or leave it floating (see “Docking/floating windows and toolbars” on page 20).

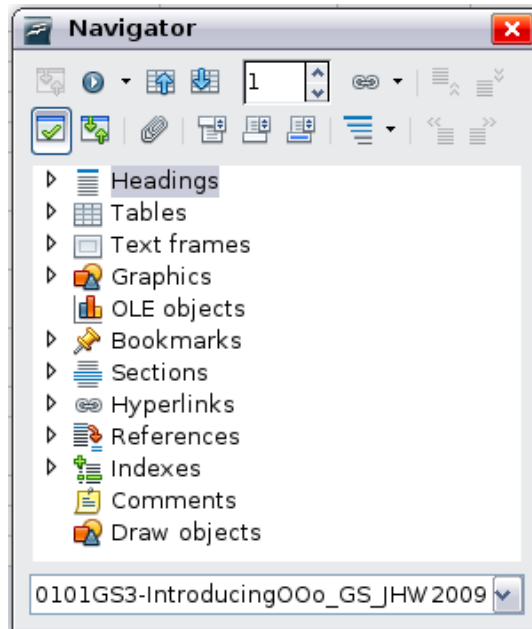



Figure 13: The Navigator

Click the marker (+ or arrow) by any of the categories to display the list of objects in that category.

To hide the list of categories and show only the toolbars at the top, click the **List Box On/Off** icon . Click this icon again to show the list box.

The Navigator provides several convenient ways to move around a document and find items in it:

- When a category is showing the list of objects in it, double-click on an object to jump directly to that object’s location in the document.

Objects are much easier to find if you have given them names when creating them, instead of keeping OOo’s default graphics1, graphics2, Table1, Table2, and so on—which may not correspond to the position of the object in the document.

If you only want to see the content in a certain category, highlight the category and click the **Content View** icon . Until you click the icon again, only the objects of that category will be displayed.

- Click the Navigation icon  (second icon from the left at the top of the Navigator) to display the Navigation toolbar. Here you can pick one of the categories and use the **Previous** and **Next** icons to move from one item to the next. This is particularly helpful for finding items like bookmarks and indexes, which can be difficult to see.

The names of the icons (shown in the tooltips) change to match the selected category; for example, **Next Graphic** or **Next Bookmark**.

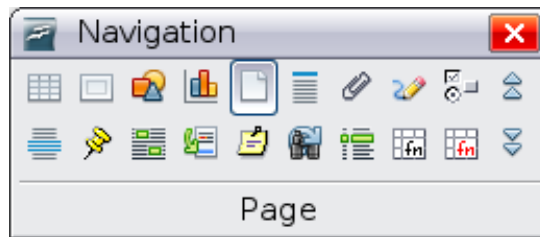

Figure 14: Navigation toolbar

- To jump to a specific page in the document, type its page number in the box at the top of the Navigator.

A bit of experimentation with the other icons will demonstrate their functions. Some component-specific uses are described in the chapters on Writer and the other components.

Undoing and redoing changes

To undo the most recent change, press *Control+Z*, or click the **Undo** icon  on the Standard toolbar, or choose **Edit > Undo** from the menu bar.

The Edit menu shows the latest change that can be undone (see below for an example from Writer).

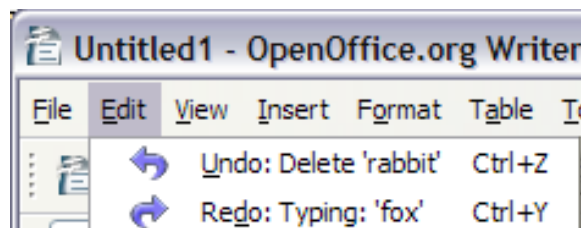

Figure 15: Edit > Undo last action

Click the small triangle to the right of the **Undo** icon to get a list of all the changes that can be undone. You can select multiple changes and undo them at the same time.

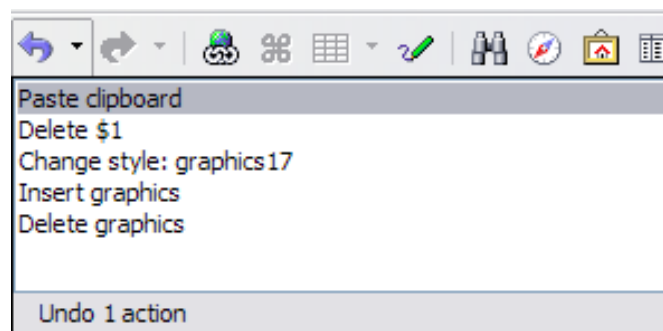



Figure 16: List of actions that can be undone

After changes have been undone, **Redo** becomes active. To redo a change, select **Edit > Redo**, or press *Control+Y* or click on the Redo icon . As with Undo, click

on the triangle to the right of the arrow to get a list of the changes that can be reapplied.

To modify the number of changes OpenOffice.org remembers, choose **Tools > Options > OpenOffice.org > Memory** and in the Undo section change **Number of steps**. Be aware that asking OOo to remember more changes consumes more computer memory.

Closing a document

To close a document, choose **File > Close**.

You can also close a document by clicking on the **Close** icon on the document window. This button looks like the X shown in Figure 17. It may be in a different location on your operating system.



Figure 17. Close icons

If more than one OOo window is open, each window looks like the sample shown on the left in Figure 17. Closing this window leaves the other OOo windows open.

If only one OOo window is open, it looks like the sample shown on the right in Figure 17. Notice the small X below the large X. Clicking the small X closes the document but leaves OOo open. Clicking the large X closes OOo completely.

If the document has not been saved since the last change, a message box is displayed. Choose whether to save or discard your changes.

- **Save:** The document is saved and then closed.
- **Discard:** The document is closed, and all modifications since the last save are lost.
- **Cancel:** Nothing happens, and you return to the document.

Caution



Not saving your document could result in the loss of recently made changes, or worse still, your entire file.

Closing OpenOffice.org

To close OOo completely, choose **File > Exit**, or close the last open document as described in “Closing a document” above.

If all the documents have been saved, OOo closes immediately. If any documents have been modified but not saved, a warning message appears. Follow the procedure in “Closing a document” to save or discard your changes.

Using OpenOffice.org on a Mac

Some keystrokes and menu items are different on a Mac from those used in Windows and Linux. The following table gives some common substitutions for the instructions in this book. For a more detailed list, see the application Help.

Windows/Linux	Mac equivalent	Effect
Tools > Options menu selection	OpenOffice.org > Preferences	Access setup options
Right-click	Control+click	Open context menu
Ctrl (Control)	⌘ (<i>Command</i>)	Used with other keys
F5	Shift+⌘+F5	Open the Navigator
F11	⌘+T	Open the Styles and Formatting window

Chapter 2

Setting up OpenOffice.org

Choosing Options to Suit the Way You Work

Choosing options for all of OOo

This section covers some of the settings that apply to all the components of OpenOffice.org. For information on settings not discussed here, see the online help.

Click **Tools > Options**. The list in the left-hand box of the Options - OpenOffice.org dialog varies depending on which component of OOo is open. The illustrations in this chapter show the list as it appears when a Writer document is open.

Click the marker (+ or triangle) by OpenOffice.org on the left-hand side. A list of pages drops down. Selecting an item in the list causes the right-hand side of the dialog to display the relevant page.

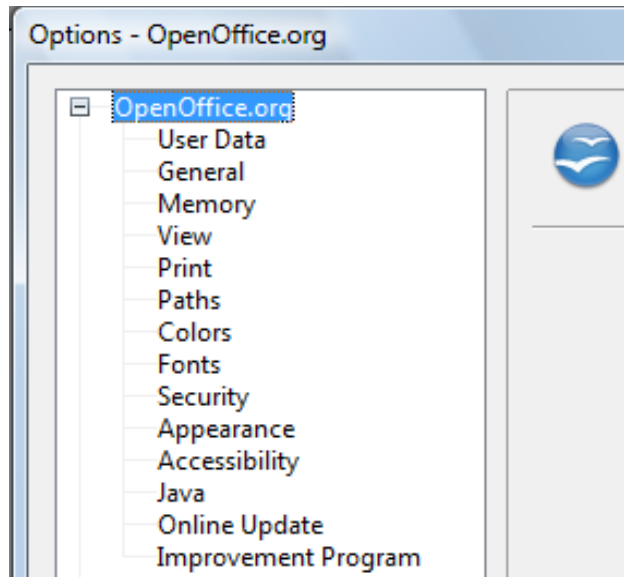

Figure 18: OpenOffice.org options

Note The **Back** button has the same effect on all pages of the Options dialog. It resets the options to the values that were in place when you opened OpenOffice.org.

User Data options

Because OOo uses the name or initials stored in the OpenOffice.org - User Data page for several things, including document properties (created by and last edited by information) and the name of the author of notes and changes, you will want to ensure that the correct information appears here.

Fill in the form (shown in Figure 19), or amend or delete any existing incorrect information.

Address

Company

First/Last name/Initials

Street

City/State/Zip

Country/Region

Title/Position

Tel. (Home/Work)

Fax / E-mail

Figure 19: Filling in user data

General options

The options on the OpenOffice.org - General page are described below.

Help

Tips

Extended tips

Help Agent

Reset Help Agent

Help formating

Open/Save dialogs

Use OpenOffice.org dialogs

Document status

Printing sets "document modified" status

Year (two digits)

Interpret as years between

Figure 20: Setting general options for OpenOffice.org

Help - Tips

When *Tips* is active, one or two words will appear when you hold the mouse pointer over an icon or field, without clicking.

Help - Extended tips

When *Extended tips* is active, a brief description of the function of a particular icon or menu command or a field on a dialog appears when you hold the mouse pointer over that item.

Help Agent

To turn off the *Help Agent* (similar to Microsoft's Office Assistant), deselect this option. To restore the default behavior, click **Reset Help Agent**.

Help formatting

High contrast is an operating system setting that changes the system color scheme to improve readability. To display Help in high contrast (if your computer's operating system supports this), choose one of the high-contrast style sheets from the pull-down list.

High-contrast style	Visual effect
Default	Black text on white background
High Contrast #1	Yellow text on black background
High Contrast #2	Green text on black background
High Contrast Black	White text on black background
High Contrast White	Black text on white background

Open/Save dialogs

To use the standard Open and Save dialogs for your operating system, deselect the **Use OpenOffice.org dialogs** option. When this option is selected, the Open and Save dialogs supplied with OpenOffice.org will be used. See Chapter 1 (Introducing OpenOffice.org) for more about the OOo Open and Save dialogs. This book uses the OOo Open and Save dialogs in illustrations.

Document status

If this option is selected, then the next time you close the document after printing, the print date is recorded in the document properties as a change and you will be prompted to save the document again, even if you did not make any other changes.

Year (two digits)

Specifies how two-digit years are interpreted. For example, if the two-digit year is set to 1930, and you enter a date of 1/1/30 or later into your document, the date is interpreted as 1/1/1930 or later. An "earlier" date is interpreted as being in the following century; that is, 1/1/20 is interpreted as 1/1/2020.

Memory options

In the Options dialog, click **OpenOffice.org > Memory**. These options control how OpenOffice.org uses your computer's memory and how much memory it requires. Before changing them, you may wish to consider the following points:

- More memory can make OpenOffice.org faster and more convenient (for example, more undo steps require more memory); but the trade-off is less memory available for other applications and you could run out of memory altogether.
- If your documents contain a lot of objects such as images, or the objects are large, OOo's performance may improve if you increase the memory for OOo or the memory per object. If you find that objects seem to disappear from a document that contains a lot of them, increase the number of objects in the cache. (The objects are still in the file even if you cannot see them on screen.)
- To load the Quickstarter (an icon on the desktop or in the system tray) when you start your computer, select the option near the bottom of the dialog. This makes OpenOffice.org start faster; the trade-off is OOo uses some memory

even when not being used. This option (sometimes called **Enable systray quickstarter**) is not available on all operating systems.

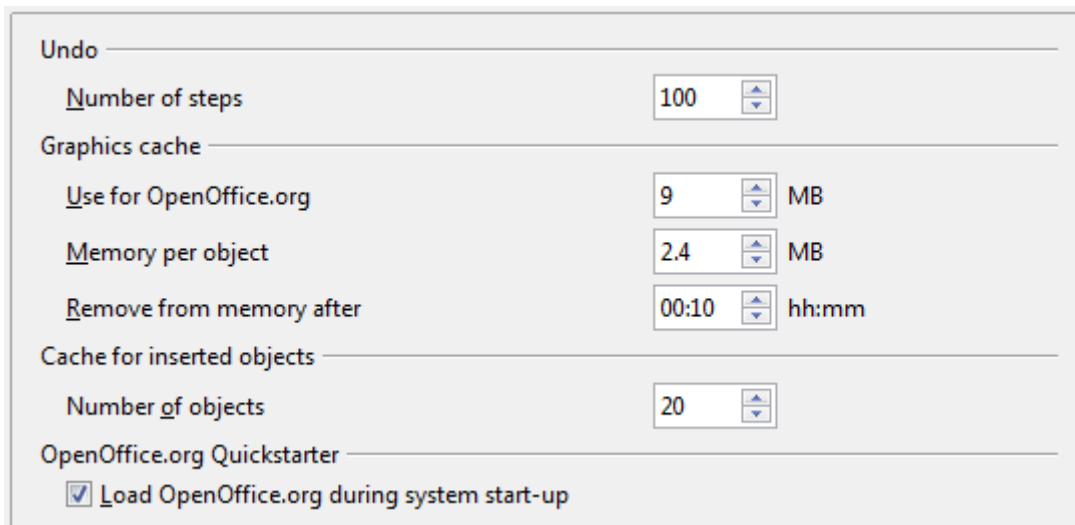

Figure 21: Choosing Memory options for the OpenOffice.org applications

View options

The options on the OpenOffice.org - View page affect the way the document window looks and behaves. Some of these options are described below. Set them to suit your personal preferences.

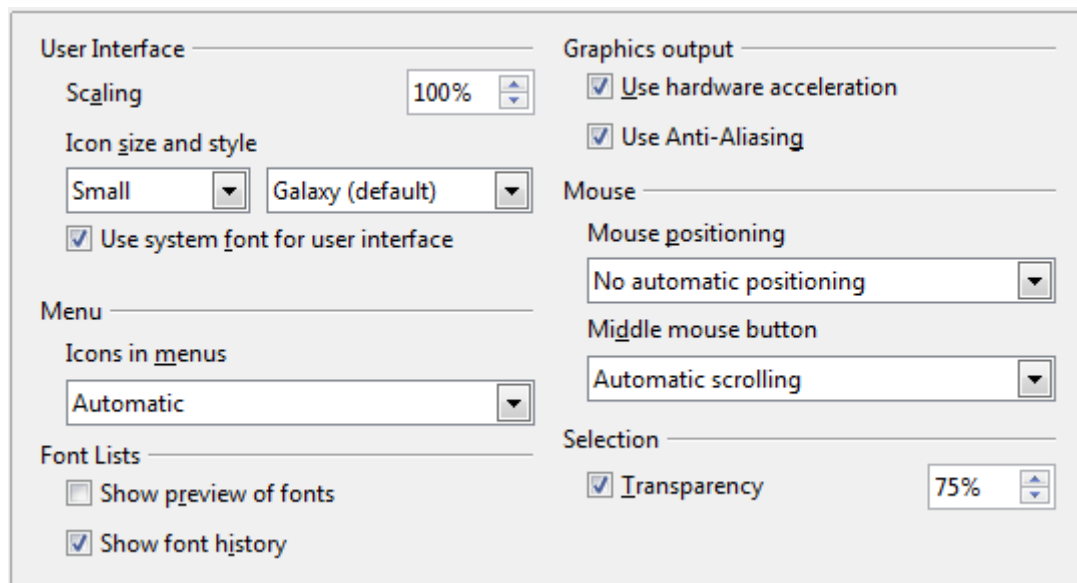

Figure 22: Choosing View options for OOO applications

User Interface - Scaling

If the text in the help files or on the menus of the OOO user interface is too small or too large, you can change it by specifying a scaling factor. Sometimes a change here can have unexpected results, depending on the screen fonts available on your system. However, it does not affect the actual font size of the text in your documents.

User Interface - Icon size and style

The first box specifies the display size of toolbar icons (Automatic, Small, or Large). The Automatic icon size option uses the setting for your operating system. The second box specifies the icon style (theme); here the Automatic option uses an icon set compatible with your operating system and choice of desktop: for example, KDE or Gnome on Linux.

User Interface - Use system font for user interface

If you prefer to use the system font (the default font for your computer and operating system) instead of the font provided by OOO for the user interface, select this option.

User interface - Screen font anti-aliasing

(Not available in Windows; not shown in Figure 22.) Select this option to smooth the screen appearance of text. Enter the smallest font size to apply anti-aliasing.

Menu - icons in menus

Causes icons as well as words to be visible in menus.

Font Lists - Show preview of fonts

Causes the font list to look like Figure 23, Left, with the font names shown as an example of the font; with the option deselected, the font list shows only the font names, not their formatting (Figure 23, Right). The fonts you will see listed are those that are installed on your system.

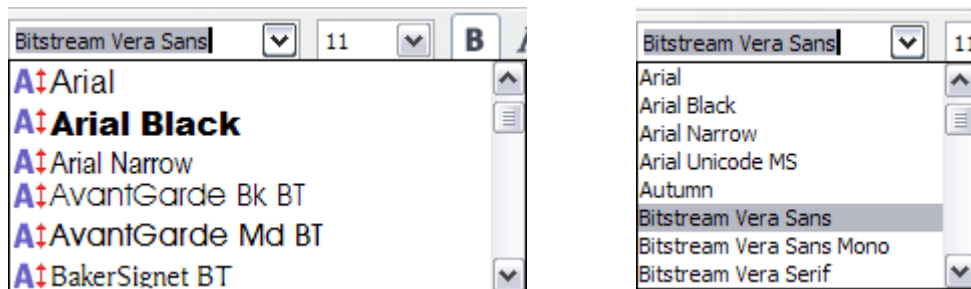

Figure 23. Font list (Left) With preview; (Right) Without preview

Font Lists - Show font history

Causes the last five fonts you have assigned to the current document are displayed at the top of the font list. Otherwise fonts are shown in alphabetical order.

Graphics output - Use hardware acceleration

Directly accesses hardware features of the graphical display adapter to improve the screen display. Not supported on all operating systems and OOO distributions.

Graphics output - Use anti-aliasing

Enables and disables anti-aliasing, which makes the display of most graphical objects look smoother and with fewer artifacts. Not supported on all operating systems and OOO distributions.

Tip

Press *Shift+Control+R* to restore or refresh the view of the current document.

Mouse positioning

Specifies if and how the mouse pointer will be positioned in newly opened dialogs.

Middle mouse button

Defines the function of the middle mouse button.

- **Automatic scrolling** - dragging while pressing the middle mouse button shifts the view.
- **Paste clipboard** - pressing the middle mouse button inserts the contents of the "Selection clipboard" at the cursor position.

The "Selection clipboard" is independent of the normal clipboard that you use by **Edit > Copy/Cut/Paste** or their respective keyboard shortcuts. Clipboard and "Selection clipboard" can contain different contents at the same time.

Function	Clipboard	Selection clipboard
Copy content	Edit > Copy <i>Control+C</i>	Select text, table, or object.
Paste content	Edit > Paste <i>Control+V</i> pastes at the cursor position.	Clicking the middle mouse button pastes at the mouse pointer position.
Pasting into another document	No effect on the clipboard contents.	The last marked selection is the content of the selection clipboard.

Selection - Transparency

Determines the appearance of selected text or graphics, which appear on a shaded background. To make the shaded background more or less dark, increase or decrease the Transparency setting.

If you prefer selected material to appear in reversed color (typically white text on a black background), deselect this option.

Print options

On the OpenOffice.org - Print page, set the print options to suit your default printer and your most common printing method.

In the *Printer warnings* section near the bottom of the page, you can choose whether to be warned if the paper size or orientation specified in your document does not match the paper size or orientation available for your printer. Having these warnings turned on can be quite helpful, particularly if you work with documents produced by people in other countries where the standard paper size is different from yours.

Tip

If your printouts are incorrectly placed on the page or chopped off at the top, bottom, or sides, or the printer is refusing to print, the most likely cause is page size incompatibility.

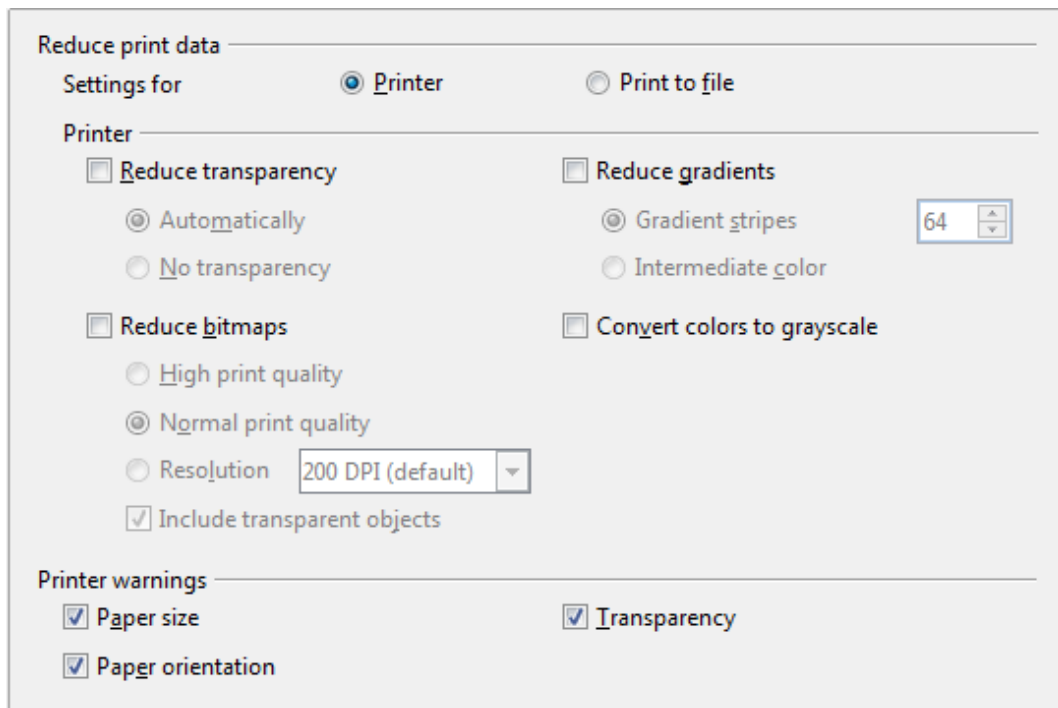

Figure 24: Choosing general printing options to apply to all OOo components

Path options

On the OpenOffice.org – Paths page, you can change the location of files associated with, or used by, OpenOffice.org to suit your working situation. In a Windows system, for example, you might want to store documents by default somewhere other than My Documents.

To make changes, select an item in the list shown in Figure 25 and click **Edit**. On the Select Path dialog (not shown; may also be titled Edit Paths), add or delete folders as required, and then click **OK** to return to the Options dialog. Note that some items can have at least two paths listed: one to a shared folder (which might be on a network) and one to a user-specific folder (normally on the user’s personal computer).

Tip

You can use the entries in the OpenOffice.org – Paths dialog to compile a list of files, such as those containing AutoText, that you need to back up or copy to another computer.

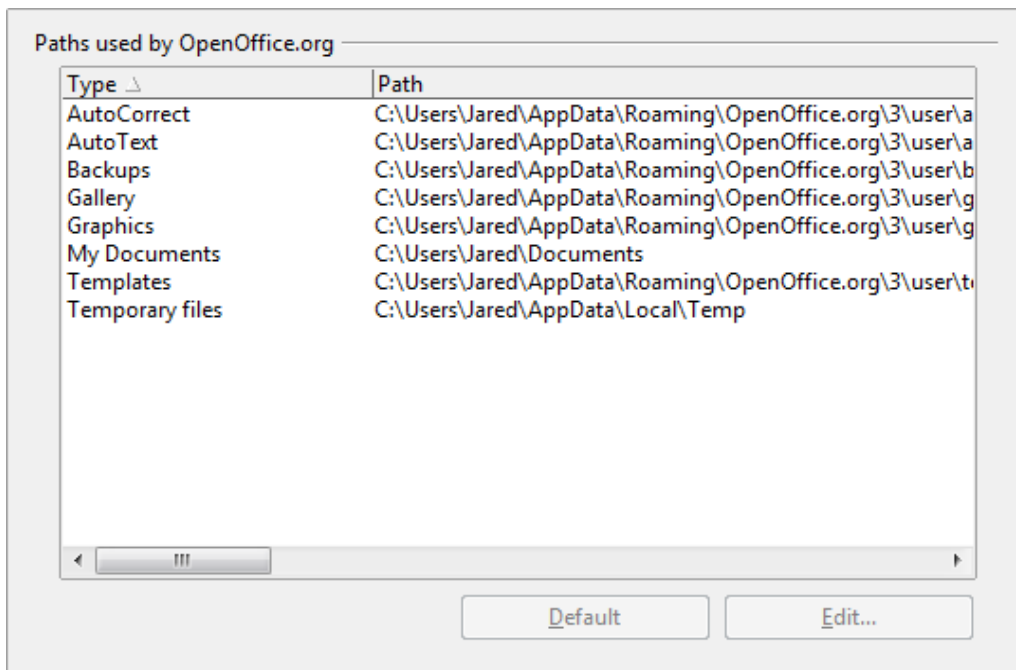

Figure 25: Viewing the paths of files used by OpenOffice.org

Color options

On the OpenOffice.org – Colors page, you can specify colors to use in OOo documents. You can select a color from a color table, edit an existing color, and define new colors. These colors are stored in your color palette and are then available in all components of OOo.

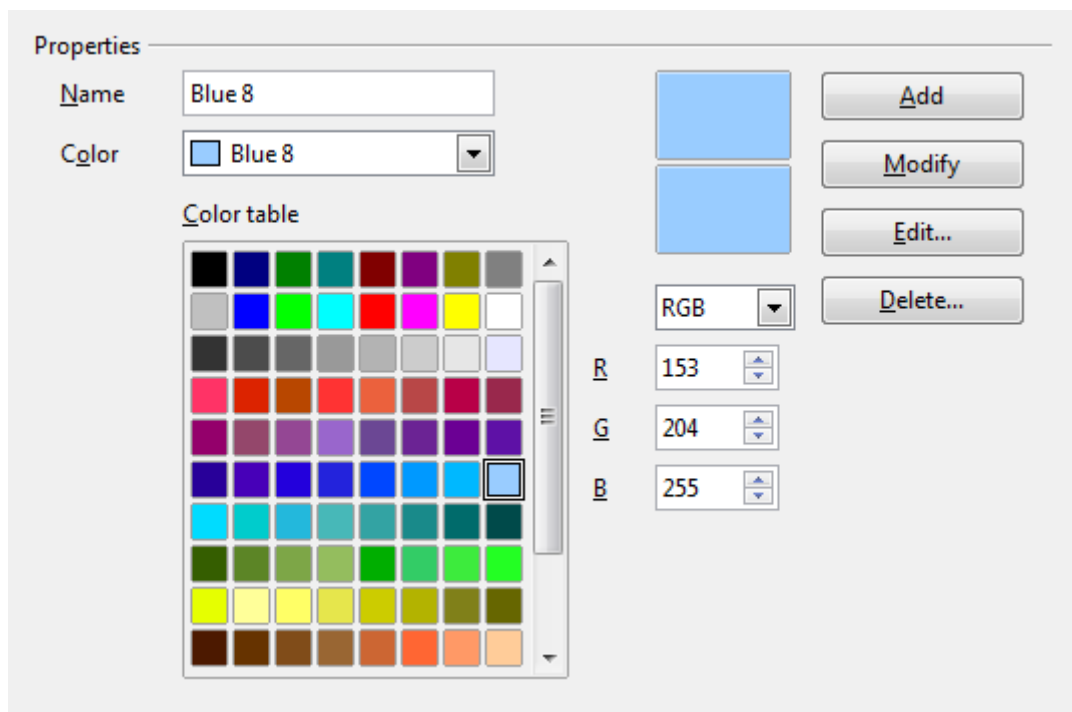

Figure 26: Defining colors to use in color palettes in OOo

To modify a color:

- 1) Select the color to modify from the list or the color table.
- 2) Enter the new values that define the color. If necessary, change the settings from RGB (Red, Green, Blue) to CMYK (Cyan, Magenta, Yellow, Black) or vice versa. The changed color appears in the lower of the two color preview boxes at the top.
- 3) Modify the *Name* as required.
- 4) Click the **Modify** button. The newly defined color is now listed in the Color table.

Alternatively, click the **Edit** button to open the Color dialog, shown in Figure 27. Here you can select a color from one of the color windows in the upper area, or you can enter values in the lower area using your choice of RGB, CMYK, or HSB (Hue, Saturation and Brightness) values.

The upper right color window is linked directly with the color input fields in the lower area; as you choose a color in the upper window, the numbers change accordingly. The two color fields at the lower right show the value of the selected color on the left and the currently set value from the color value fields on the right.

Modify the color components as required and click **OK** to exit the dialog. The newly defined color now appears in the lower of the color preview boxes shown in Figure 26. Type a name for this color in the *Name* box, then click the **Add** button. A small box showing the new color is added to the Color table.

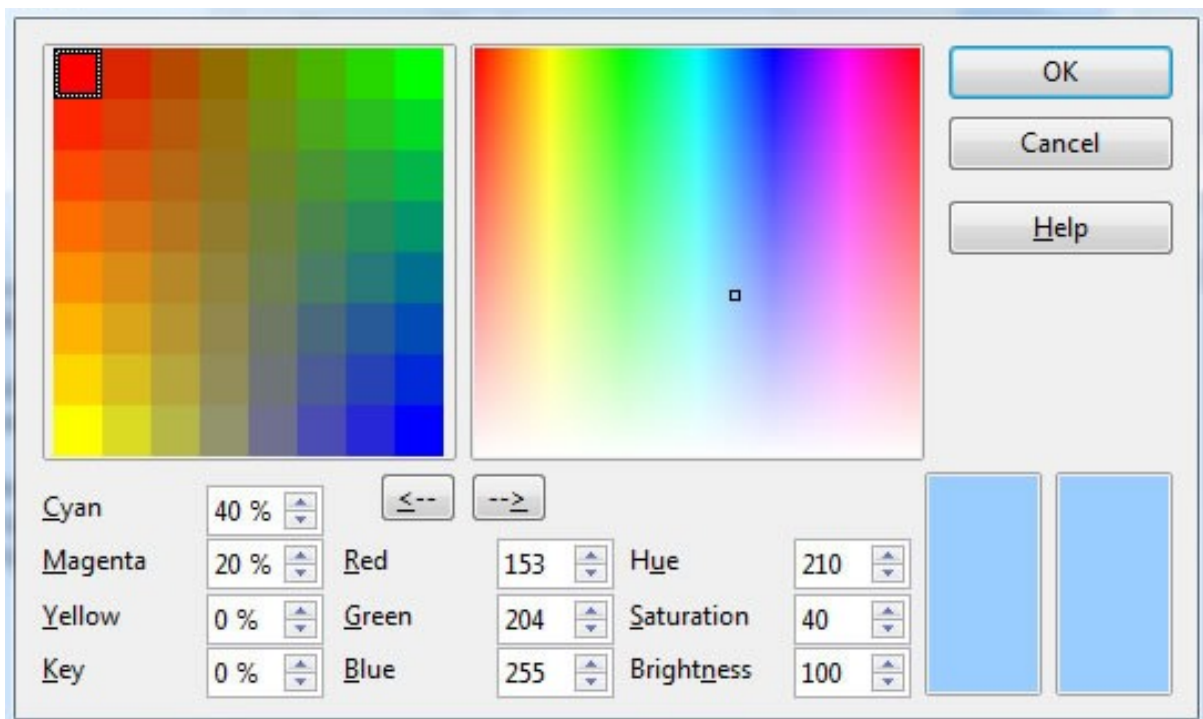

Figure 27: Editing colors

Another way to define or alter colors is through the Colors page of the Area dialog, where you can also save and load palettes, a feature that is not possible here. In Calc, draw a temporary draw object and use the context menu of this object to open the Area dialog. If you load a palette in one component of OoO, it is only active in that component; the other components keep their own palettes.

Font options

You can define replacements for any fonts that might appear in your documents. If you receive from someone else a document containing fonts that you do not have on your system, OpenOffice.org will substitute fonts for those it does not find. You might prefer to specify a different font from the one the program chooses.

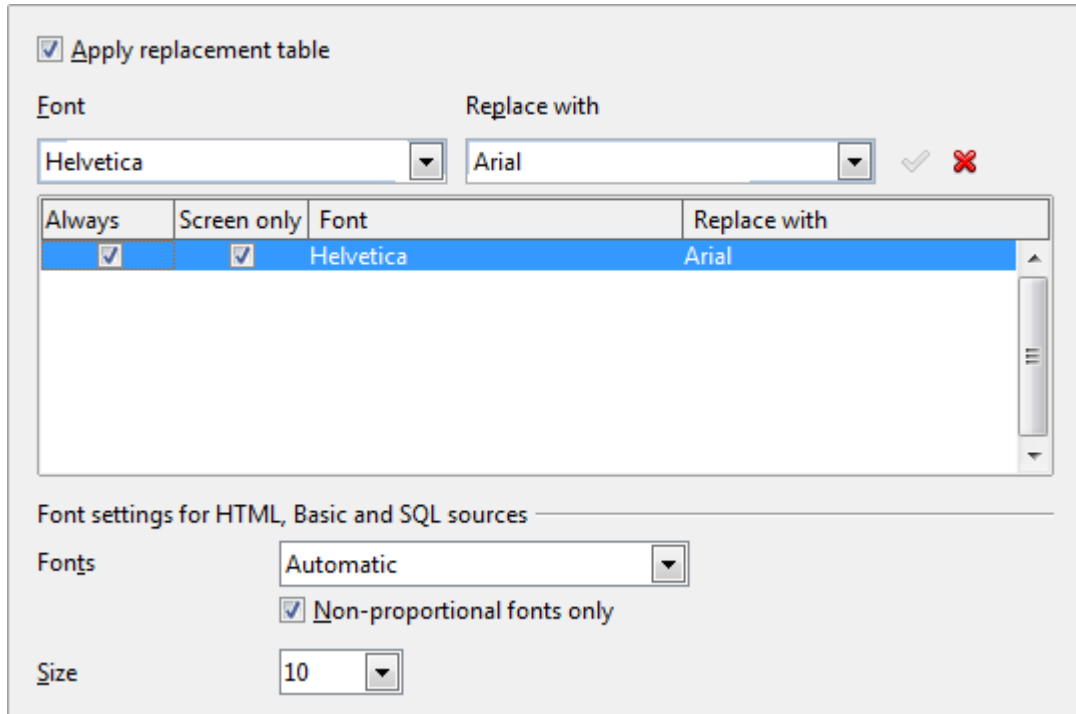

Figure 28: Defining a font to be substituted for another font

On the OpenOffice.org – Fonts page:

- 1) Select the **Apply Replacement Table** option.
- 2) Select or type the name of the font to be replaced in the **Font** box. (If you do not have this font on your system, it will not appear in the drop-down list in this box, so you need to type it in.)
- 3) In the **Replace with** box, select a suitable font from the drop-down list of fonts installed on your computer.
- 4) The checkmark to the right of the **Replace with** box turns green. Click on this checkmark. A row of information now appears in the larger box below the input boxes. Select the options under **Always** and **Screen**.
- 5) In the bottom section of the page, you can change the typeface and size of the font used to display source code such as HTML and Basic (in macros).

Security options

Use the OpenOffice.org – Security page to choose security options for saving documents and for opening documents that contain macros.

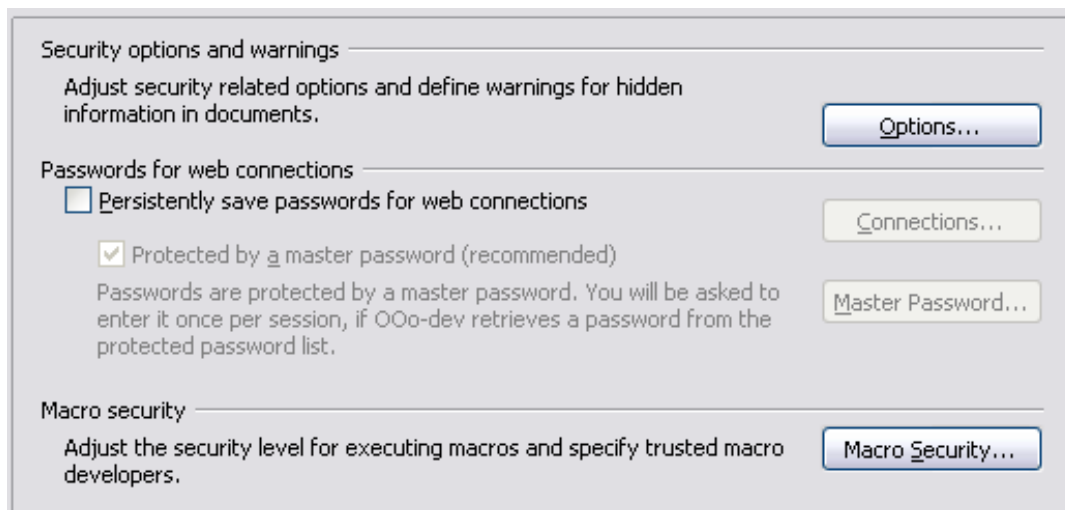

Figure 29: Choosing security options for opening and saving documents

Security options and warnings

If you record changes, save multiple versions, or include hidden information or notes in your documents, and you do not want some of the recipients to see that information, you can set warnings to remind you to remove it, or you can have OOO remove some of it automatically. Note that (unless removed) much of this information is retained in a file whether the file is in OpenOffice.org's default OpenDocument format, or has been saved to other formats, including PDF.

Click the **Options** button to open a separate dialog with specific choices (Figure 30).

Macro security

Click the **Macro Security** button to open the Macro Security dialog (not shown here), where you can adjust the security level for executing macros and specify trusted sources.

Security options and warnings

The following options are on the Security options and warnings dialog (Figure 30).

Remove personal information on saving

Select this option to always remove user data from the file properties when saving the file. To manually remove personal information from specific documents, deselect this option and then use the **Delete** button under **File > Properties > General**.

Ctrl-click required to follow hyperlinks

In older versions of OOO, clicking on a hyperlink in a document opened the linked document. Now you can choose whether to keep this behavior (by unchecking this box). Many people find creation and editing of documents easier when accidental clicks on links do not activate the links.

The other options on this dialog should be self-explanatory.

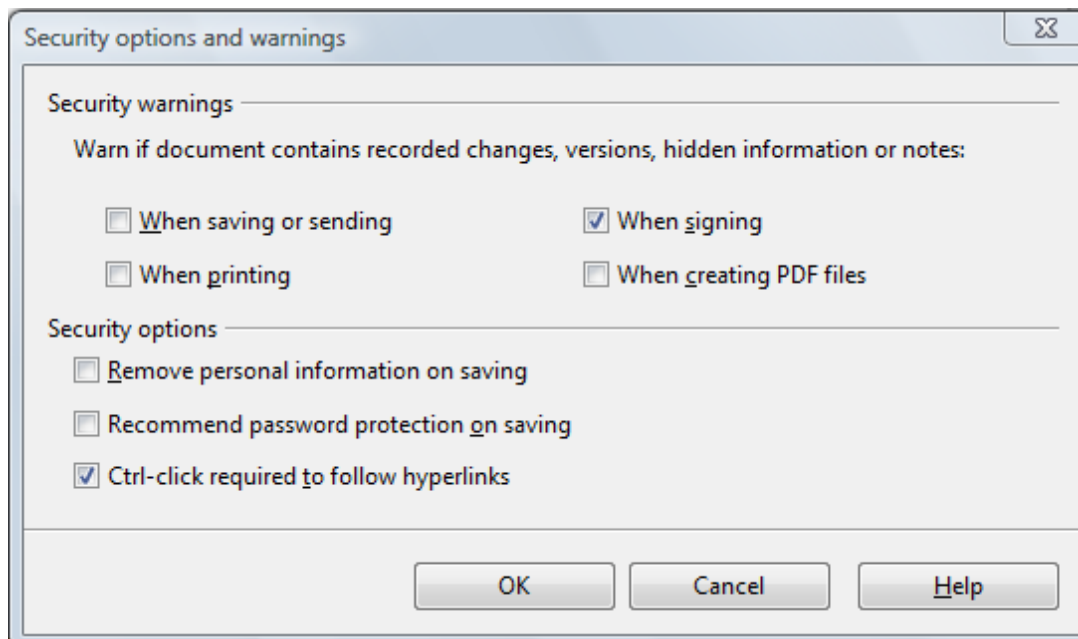

Figure 30: Security options and warnings dialog

Appearance options

Writing, editing, and (especially) page layout are often easier when you can see the page margins (text boundaries), the boundaries of tables and sections (in Writer documents), page breaks in Calc, grid lines in Draw or Writer, and other features. In addition, you might prefer to use colors that are different from Oo's defaults for such items as note indicators or field shadings.

On the OpenOffice.org – Appearance page, you can specify which items are visible and the colors used to display various items.

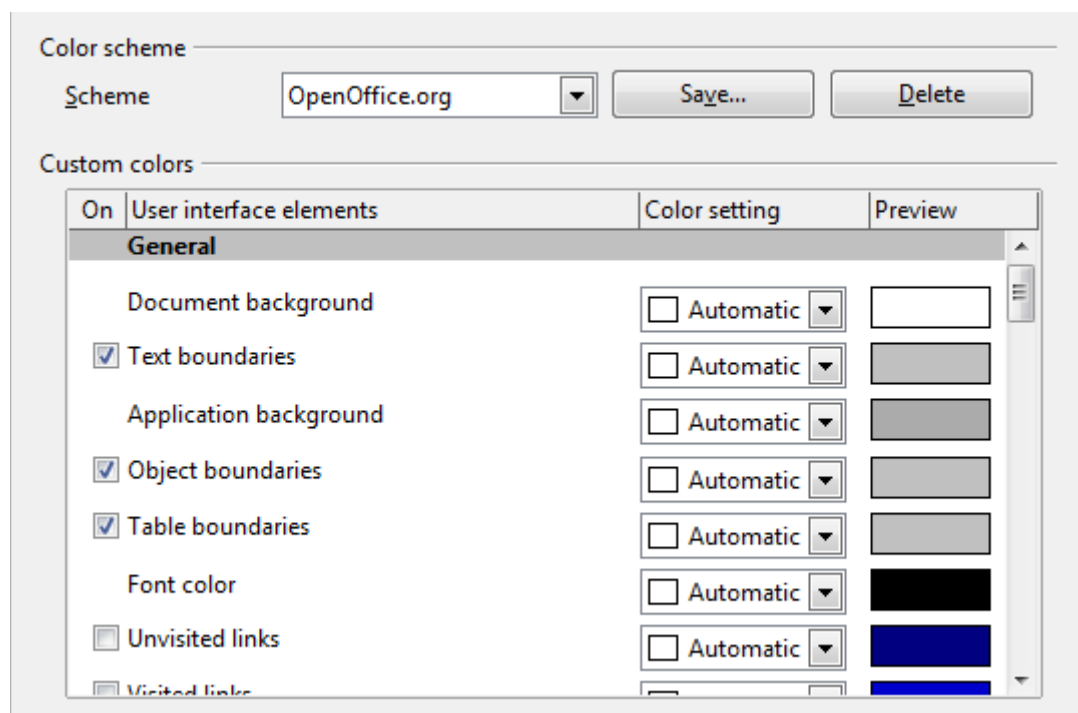

Figure 31: Showing or hiding text, object, and table boundaries

- To show or hide items such as text boundaries, select or deselect the options next to the names of the items.
- To change the default colors for items, click the down-arrow in the *Color Setting* column by the name of the item and select a color from the pop-up box.
- To save your color changes as a color scheme, click **Save**, type a name in the *Scheme* box; then click **OK**.

Accessibility options

Accessibility options include whether to allow animated graphics or text, how long help tips remain showing, some options for high contrast display, and a way to change the font for the user interface of the OpenOffice.org program.

Accessibility support relies on Sun Microsystems Java technology for communications with assistive technology tools. See “Java options” below. The *Support assistive technology tools* option is not shown on all OOO installations. See *Assistive Tools in OpenOffice.org* in the Help for other requirements and information.

Select or deselect the options as required.

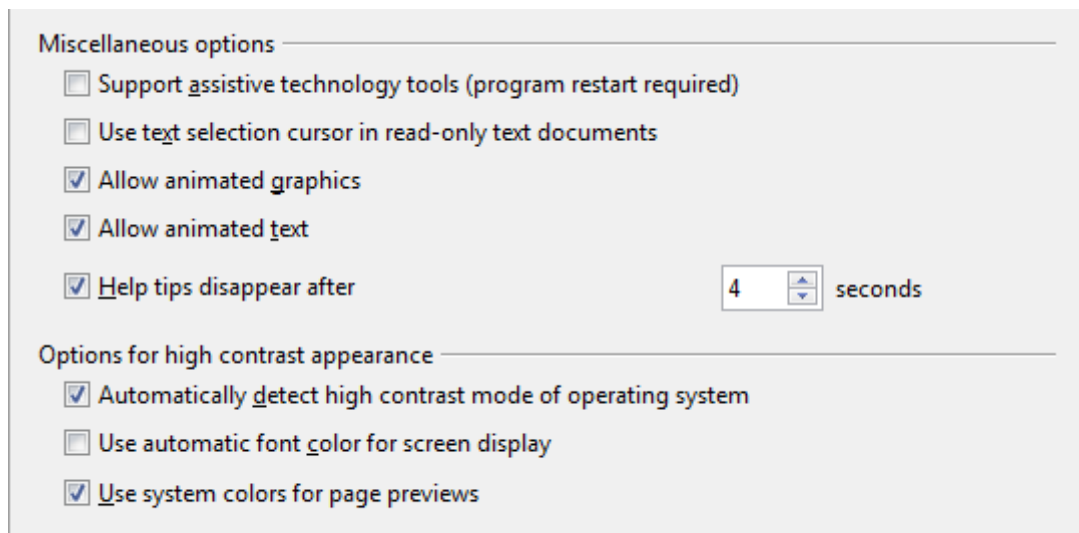

Figure 32: Choosing accessibility options

Java options

If you install or update a Java Runtime Environment (JRE) after you install OpenOffice.org, or if you have more than one JRE installed on your computer, you can use the OpenOffice.org - Java options page to choose the JRE for OOO to use.

If you are a system administrator, programmer, or other person who customizes JRE installations, you can use the Parameters and Class Path pages (reached from the Java page) to specify this information.

If you do not see anything listed in the middle of the page, wait a few minutes while OOO searches for JREs on the hard disk.

If OOO finds one or more JREs, it will display them there. You can then select the **Use a Java runtime environment** option and (if necessary) choose one of the JREs listed.

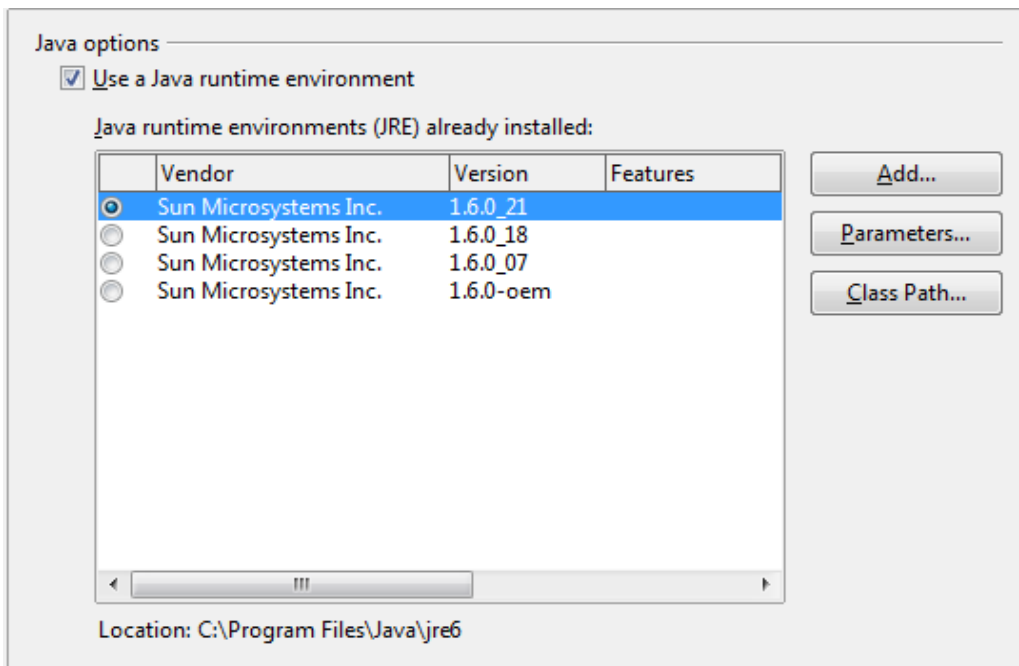

Figure 33: Choosing a Java runtime environment

Online Update options

On the OpenOffice.org – Online Update page, you can choose whether and how often to have OOO check the OOO website for program updates. If the **Check for updates automatically** option is selected, an icon appears at the right-hand end of the menu bar when an update is available. Click this icon to open a dialog where you can choose to download the update.

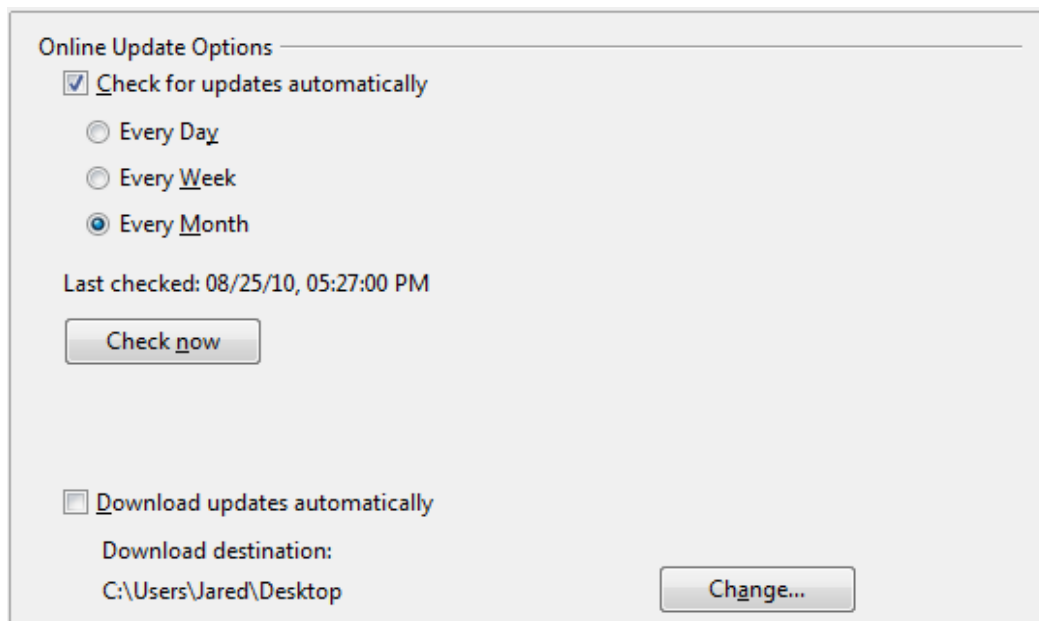

Figure 34: Configuring Online Update

If the **Download updates automatically** option is selected, the download starts when you click the icon. To change the download destination, click the **Change** button and select the required folder in the file browser window.

Improvement program

On the OpenOffice.org – Improvement Program page, you can choose whether or not to participate in the OpenOffice.org Improvement Program, which collects anonymous statistics about how you use OOo.

Choosing options for loading and saving documents

You can set the Load/Save options to suit the way you work.

If the Options dialog is not already open, click **Tools > Options**. Click the expansion symbol (+ or triangle) to the left of **Load/Save**.

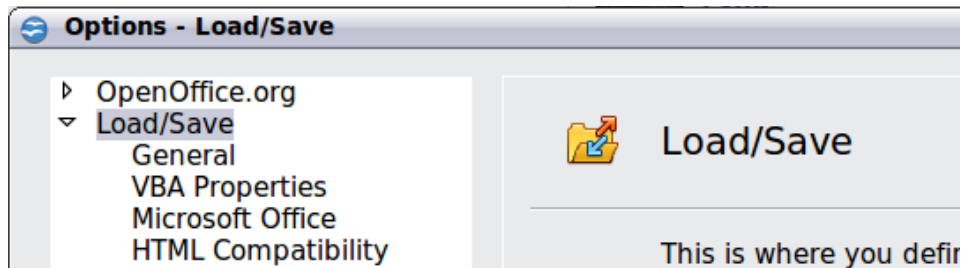

Figure 35: Load/Save options

General Load/Save options

Most of the choices on the Load/Save – General page are familiar to users of other office suites. Some items of interest are described below.

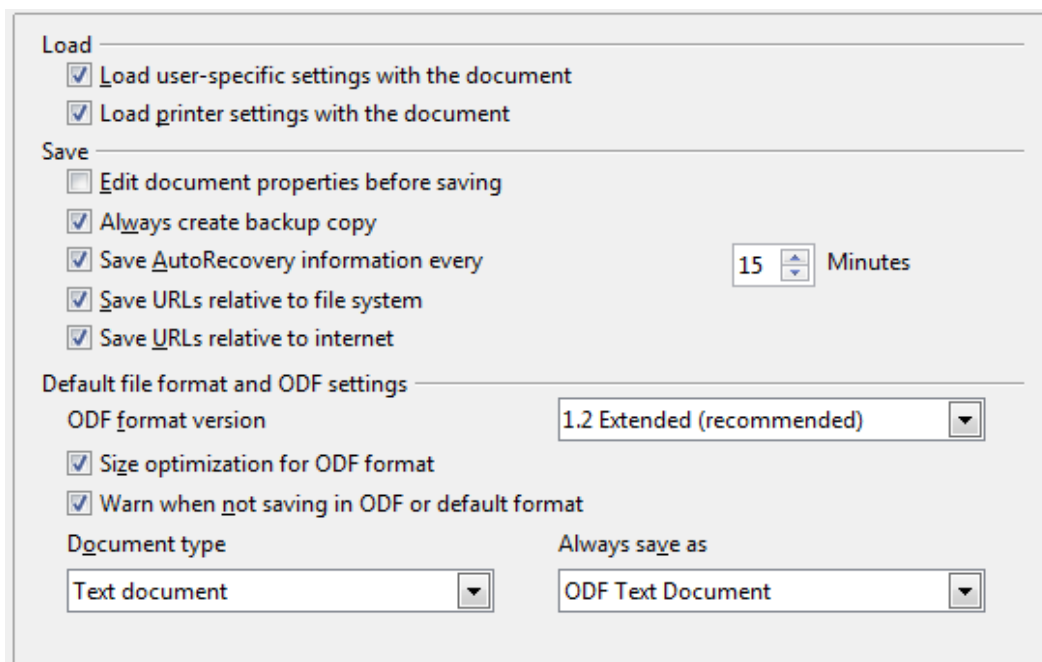

Figure 36. Choosing Load and Save options

Load user-specific settings with the document

When you save a document, certain settings are saved with it. Some settings (printer name, data source linked to the document) are always loaded with a document, whether or not this option is selected. If you select this option, these

document settings are overruled by the user-specific settings of the person who opens it. If you deselect this option, the user's personal settings do not overrule the settings in the document. For example, your choice (in the options for OOO Writer) of how to update links is affected by the **Load user-specific settings** option.

Load printer settings with the document

If this option is **not** selected, the printer settings that are stored with the document are ignored when you print it using the **Print File Directly** icon. The default printer in your system will be used instead.

Edit document properties before saving

If you select this option, the Document Properties dialog pops up to prompt you to enter relevant information the first time you save a new document (or whenever you use **Save As**).

Save AutoRecovery information every

Choose whether to enable AutoRecovery and how often to save the information used by the AutoRecovery process.

AutoRecovery in OpenOffice.org overwrites the original file. If you also choose **Always create backup copy**, the original file then overwrites the backup copy. If you have this set, recovering your document after a system crash will be easier; but recovering an earlier version of the document may be harder.

Save URLs relative to file system / internet

Relative addressing to a file system is only possible if the source document and the referenced document are both on the same drive. A relative address always starts from the directory in which the current document is located. It is recommended to save relatively if you want to create a directory structure on an Internet server.

Default file format and ODF settings

ODF format version. OpenOffice.org by default saves documents in OpenDocument Format (ODF) version 1.2 Extended. While this allows for improved functionality, there may be backwards compatibility issues. When a file saved in ODF 1.2 Extended is opened in an earlier version of OpenOffice.org (using ODF 1.0/1.1), some of the advanced features may be lost. Two notable examples are cross-references to headings and the formatting of numbered lists. If you plan to share documents with people who are still using older versions of OpenOffice.org, save the document using ODF version 1.0/1.1.

Size optimization for ODF format. OpenOffice.org documents are XML files. When you select this option, OOO writes the XML data without indents and line breaks. If you want to be able to read the XML files in a text editor in a structured form, deselect this option.

Document type. If you routinely share documents with users of Microsoft Office, you might want to change the **Always save as** attribute for documents to one of the Microsoft Office formats.

Note

Although OOO can open files in the .docx, .xlsx, and .pptx formats produced by Microsoft Office 2007, it cannot save in those formats. This capability is planned for a future release.

VBA Properties Load/Save options

On the Load/Save - VBA Properties page, you can choose whether to keep any macros in Microsoft Office documents that are opened in OpenOffice.org.

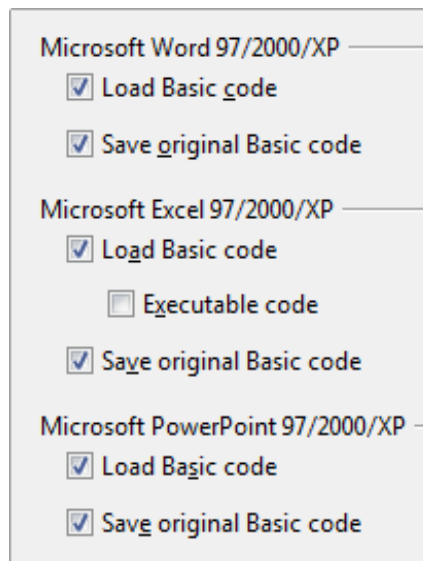

Figure 37: Choosing Load/Save VBA Properties

- If you choose **Save original Basic code**, the macros will not work in OOo but are retained if you save the file into Microsoft Office format.
- If you choose **Load Basic code to edit**, the changed code is saved in an OOo document but is not retained if you save into a Microsoft Office format.
- If you are importing a Microsoft Excel file containing VBA code, you can select the option **Executable code**. Whereas normally the code is preserved but rendered inactive (if you inspect it with the StarBasic IDE you will notice that it is all commented), with this option the code is ready to be executed.

Microsoft Office Load/Save options

On the Load/Save - Microsoft Office page, you can choose what to do when importing and exporting Microsoft Office OLE objects (linked or embedded objects or documents such as spreadsheets or equations).

Select the [L] options to convert Microsoft OLE objects into the corresponding OpenOffice.org OLE objects when a Microsoft document is loaded into OOo (mnemonic: "L" for "load").

Select the [S] options to convert OpenOffice.org OLE objects into the corresponding Microsoft OLE objects when a document is saved in a Microsoft format (mnemonic: "S" for "save").

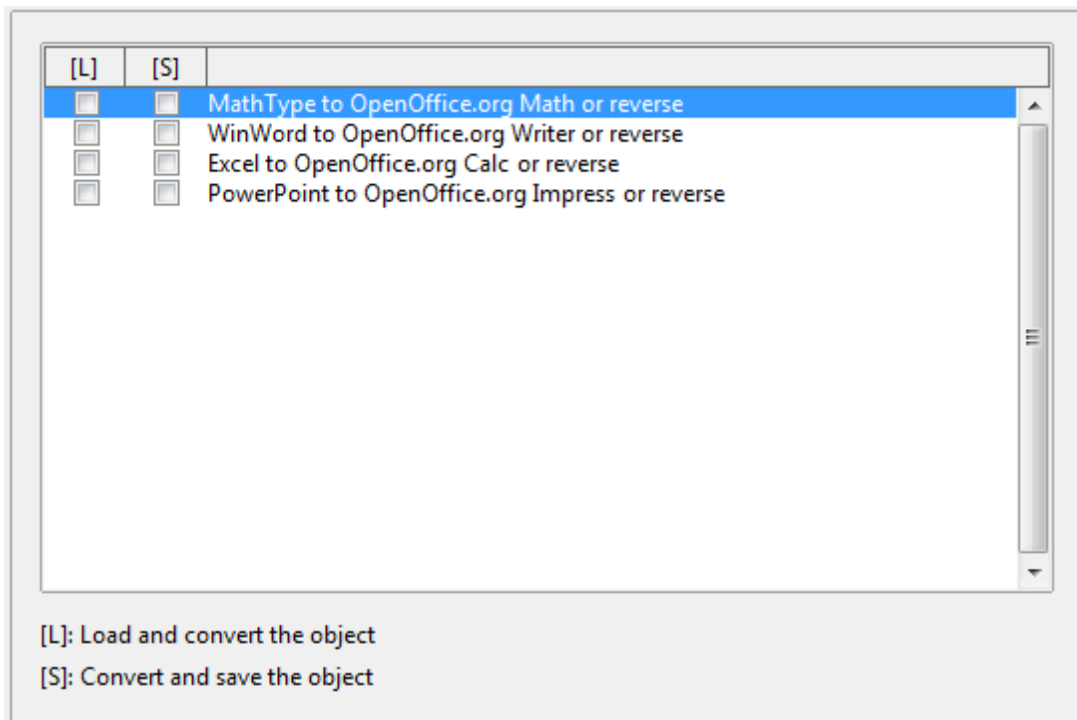

Figure 38: Choosing Load/Save Microsoft Office options

HTML compatibility Load/Save options

Choices made on the Load/Save - HTML Compatibility page affect HTML pages imported into OpenOffice.org and those exported from Oo. See *HTML documents; importing/exporting* in the Help for more information.

Font sizes

Use these fields to define the respective font sizes for the HTML `` to `` tags, if they are used in the HTML pages. (Many pages no longer use these tags.)

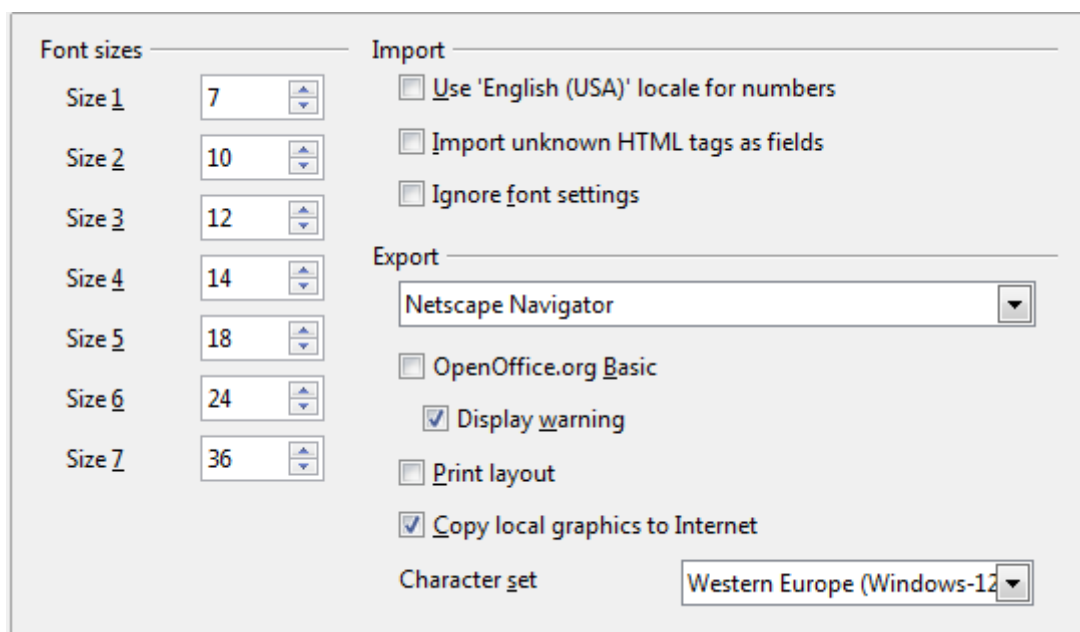

Figure 39. Choosing HTML compatibility options

Import - Use 'English (USA)' locale for numbers

When importing numbers from an HTML page, the decimal and thousands separator characters differ according to the locale of the HTML page. The clipboard, however, contains no information about the locale. If this option is **not** selected, numbers will be interpreted according to the **Language - Locale setting** in **Tools > Options > Language Settings > Languages** (see page 51). If this option is selected, numbers will be interpreted as for the English (USA) locale.

Import - Import unknown HTML tags as fields

Select this option if you want tags that are not recognized by OOO to be imported as fields. For an opening tag, an HTML_ON field will be created with the value of the tag name. For a closing tag, an HTML_OFF will be created. These fields will be converted to tags in the HTML export.

Import - Ignore font settings

Select this option to have OOO ignore all font settings when importing. The fonts that were defined in the HTML Page Style will be used.

Export

To optimize the HTML export, select a browser or HTML standard from the **Export** box. If OpenOffice.org Writer is selected, specific OpenOffice.org Writer instructions are exported.

Export - OpenOffice.org Basic

Select this option to include OOO Basic macros (scripts) when exporting to HTML format. You must activate this option *before* you create the OpenOffice.org Basic macro; otherwise the script will not be inserted. OpenOffice.org Basic macros must be located in the header of the HTML document. Once you have created the macro in the OpenOffice.org Basic IDE, it appears in the source text of the HTML document in the header.

If you want the macro to run automatically when the HTML document is opened, choose **Tools > Customize > Events**. See Chapter 13 (Getting Started with Macros) for more information.

Export - Display warning

When the **OpenOffice.org Basic** option (see above) is *not* selected, the **Display warning** option becomes available. If the **Display warning** option is selected, then when exporting to HTML a warning is shown that OpenOffice.org Basic macros will be lost.

Export - Print layout

Select this option to export the print layout of the current document as well. The HTML filter supports CSS2 (Cascading Style Sheets Level 2) for printing documents. These capabilities are only effective if print layout export is activated.

Export - Copy local graphics to Internet

Select this option to automatically upload the embedded pictures to the Internet server when uploading using FTP.

Export - Character set

Select the appropriate character set for the export.

Choosing language settings

You may need to do several things to set the language settings to what you want:

- Install the required dictionaries
- Change some locale and language settings
- Choose spelling options

Install the required dictionaries

OOo automatically installs several dictionaries with the program. To add other dictionaries, be sure you are connected to the Internet, and then use **Tools > Language > More Dictionaries Online**. OOo will open your default web browser to a page containing links to additional dictionaries that you can install. Follow the prompts to select and install the ones you want.

Change locale and language settings

You can change some details of the locale and language settings that OOo uses for all documents, or for specific documents.

In the Options dialog, click **Language Settings > Languages**.

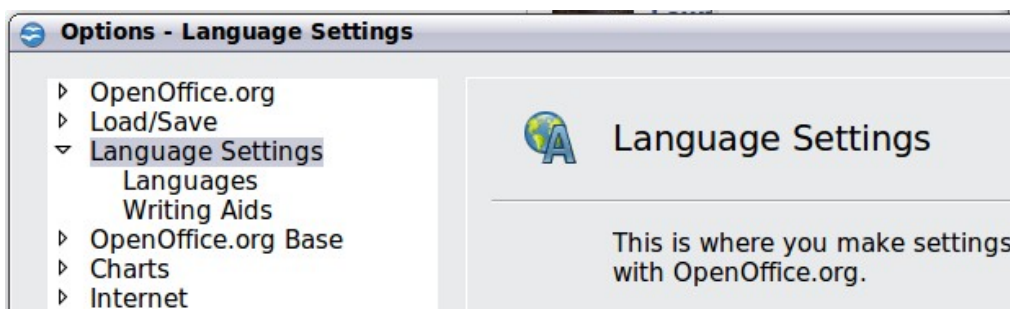

Figure 40: Language Setting Options

On the right-hand side of the Language Settings - Languages page, change the *User interface*, *Locale setting*, *Default currency*, and *Default languages for documents* as required. In the example, English (UK) has been chosen for all the appropriate settings.

If you want the language (dictionary) setting to apply to the current document only, instead of being the default for all new documents, select the option labelled *For the current document only*.

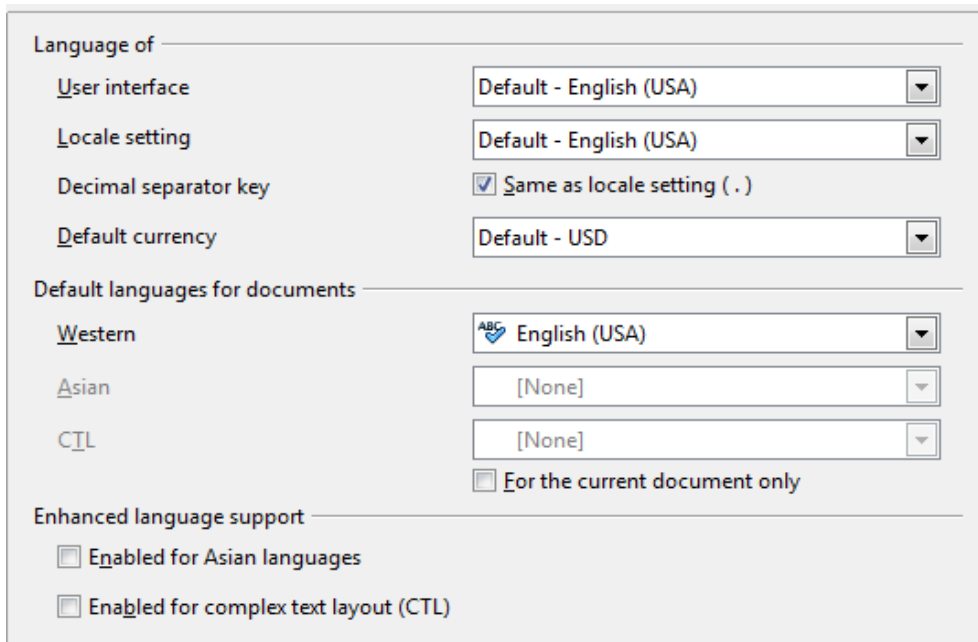

Figure 41: Choosing language options

If necessary, select the options to enable support for Asian languages (Chinese, Japanese, Korean) and support for CTL (complex text layout) languages such as Urdu, Thai, Hebrew, and Arabic. If you choose either of these options, the next time you open this dialog, you will see some extra choices under Language Settings, as shown below. These choices (*Searching in Japanese, Asian Layout, and Complex Text Layout*) are not discussed here.

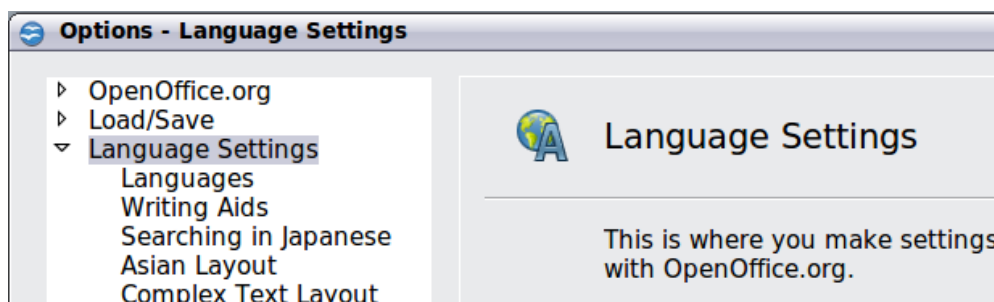

Figure 42: Extra pages available when enhanced language support options are selected

Choose spelling options

To choose the options for checking spelling, click **Language Settings > Writing Aids**. In the *Options* section of the page (Figure 43), choose the settings that are useful for you. Some considerations:

- If you do not want spelling checked while you type, deselect **Check spelling as you type** and select **Do not mark errors**. (To find the second item, scroll down in the Options list.)
- If you use a custom dictionary that includes words in all upper case and words with numbers (for example, AS/400), select **Check uppercase words** and **Check words with numbers**.
- **Check special regions** includes headers, footers, frames, and tables when checking spelling.

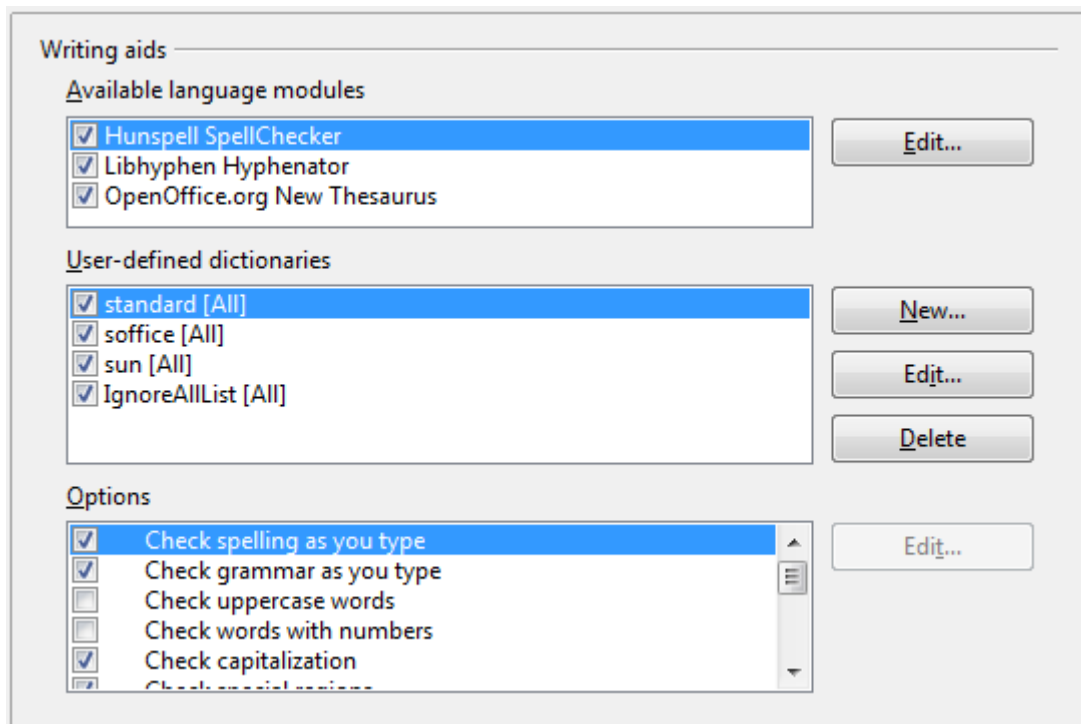

Figure 43: Choosing languages, dictionaries, and options for checking spelling

Here you can also check which user-defined (custom) dictionaries are active by default, and add or remove dictionaries, by clicking the **New** or **Delete** buttons.

Note

OpenOffice.org does not have a grammar checker, but you can install a grammar checker extension such as Language Tool and access that tool from **Tools > Spelling and Grammar**. See Chapter 14 for more about installing extensions.

Choosing Internet options

Use the Internet Options pages to define search engines and save proxy settings for use with OpenOffice.org.

If you are using a Netscape or Mozilla browser (such as Firefox), you can enable the Browser Plug-in so you can open Oo files in your browser, print them, save them, and work with them in other ways.

If you are using a Unix- or Linux-based operating system (including Mac OS X), an additional page of E-mail options is available, where you can specify the e-mail program to use when you send the current document as e-mail. Under Windows the operating system's default e-mail program is always used.

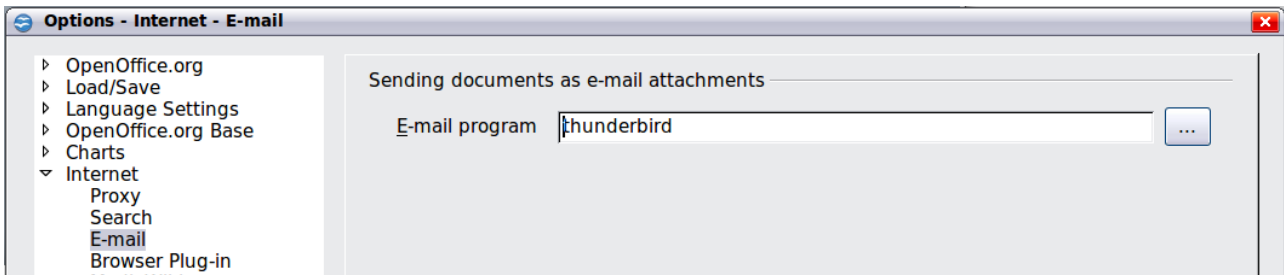

Figure 44: Internet options, showing E-mail page available to Linux users.

Controlling OOO's AutoCorrect functions

Some people find some or all of the items in OOO's AutoCorrect function annoying because they change what you type when you do not want it changed. Many people find some of the AutoCorrect functions quite helpful; if you do, then select the relevant options. But if you find unexplained changes appearing in your document, this is a good place to look to find the cause.

To open the AutoCorrect dialog, click **Tools > AutoCorrect Options**. (You need to have a document open for this menu item to appear.)

In Writer, this dialog has five tabs, as shown in Figure 45. In other components of OOO, the dialog has only four tabs.

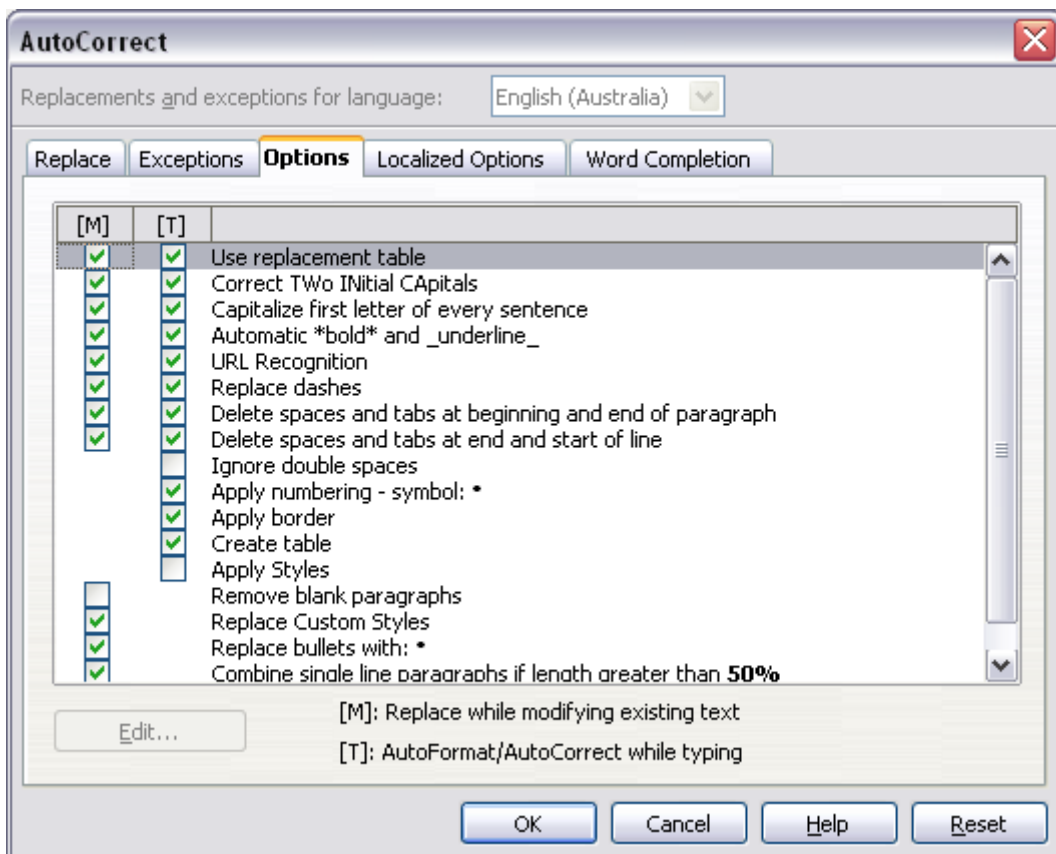

Figure 45: The AutoCorrect dialog in Writer, showing the five tabs and some of the choices

Chapter 3

Using Styles and Templates

What is a template?

A *template* is a model that you use to create other documents. For example, you can create a template for business reports that has your company's logo on the first page. New documents created from this template will all have your company's logo on the first page.

Templates can contain anything that regular documents can contain, such as text, graphics, a set of styles, and user-specific setup information such as measurement units, language, the default printer, and toolbar and menu customization.

All documents in OpenOffice.org (OOo) are based on templates. You can create a specific template for any document type (text, spreadsheet, drawing, presentation). If you do not specify a template when you start a new document, then the document is based on the default template for that type of document. If you have not specified a default template, OOo uses the blank template for that type of document that is installed with OOo. See "Setting a default template" on page 70 for more information.

What are styles?

A *style* is a set of formats that you can apply to selected pages, text, frames, and other elements in your document to quickly change their appearance. When you apply a style, you apply a whole group of formats at the same time.

Many people manually format paragraphs, words, tables, page layouts, and other parts of their documents without paying any attention to styles. They are used to writing documents according to *physical* attributes. For example, you might specify the font family, font size, and any formatting such as bold or italic.

Styles are *logical* attributes. Using styles means that you stop saying "font size 14pt, Times New Roman, bold, centered", and you start saying "Title" because you have defined the "Title" style to have those characteristics. In other words, styles means that you shift the emphasis from what the text (or page, or other element) looks like, to what the text *is*.

Styles help improve consistency in a document. They also make major formatting changes easy. For example, you may decide to change the indentation of all paragraphs, or change the font of all titles. For a long document, this simple task can be prohibitive. Styles make the task easy.

In addition, styles are used by OpenOffice.org for many processes, even if you are not aware of them. For example, Writer relies on heading styles (or other styles you specify) when it compiles a table of contents. Some common examples of style use are given in "Examples of style use" on page 73.

OpenOffice.org supports the following types of styles:

- *Page styles* include margins, headers and footers, borders and backgrounds. In Calc, page styles also include the sequence for printing sheets.
- *Paragraph styles* control all aspects of a paragraph's appearance, such as text alignment, tab stops, line spacing, and borders, and can include character formatting.
- *Character styles* affect selected text within a paragraph, such as the font and size of text, or bold and italic formats.
- *Frame styles* are used to format graphic and text frames, including wrapping type, borders, backgrounds, and columns.

- *Numbering styles* apply similar alignment, numbering or bullet characters, and fonts to numbered or bulleted lists.
- *Cell styles* include fonts, alignment, borders, background, number formats (for example, currency, date, number), and cell protection.
- *Graphics styles* in drawings and presentations include line, area, shadowing, transparency, font, connectors, dimensioning, and other attributes.
- *Presentation styles* include attributes for font, indents, spacing, alignment, and tabs.

Different styles are available in the various components of OOO, as listed in Table 1.

OpenOffice.org comes with many predefined styles. You can use the styles as provided, modify them, or create new styles, as described in this chapter.

Table 1. Styles available in OOO components

Style Type	Writer	Calc	Draw	Impress
Page	X	X		
Paragraph	X			
Character	X			
Frame	X			
Numbering	X			
Cell		X		
Presentation			X	X
Graphics	(included in Frame styles)		X	X

Applying styles

OpenOffice.org provides several ways for you to select styles to apply.

Using the Styles and Formatting window

- 1) Click the **Styles and Formatting** icon  located at the left-hand end of the object bar, or click **Format > Styles and Formatting**, or press *F11*. The Styles and Formatting window shows the types of styles available for the OOO component you are using. Figure 46 shows the window for Writer, with Page Styles visible.
You can move this window to a convenient position on the screen or dock it to an edge (hold down the *Ctrl* key and drag it by the title bar to where you want it docked).
- 2) Click on one of the icons at the top left of the Styles and Formatting window to display a list of styles in a particular category.
- 3) To apply an existing style (except for character styles), position the insertion point in the paragraph, frame, or page, and then double-click on the name of the style in one of these lists. To apply a character style, select the characters first.

Tip

At the bottom of the Styles and Formatting window is a dropdown list. In Figure 46 the window shows *Automatic*, meaning the list includes only styles applied automatically by Oo. You can choose to show all styles or other groups of styles, for example only custom styles.

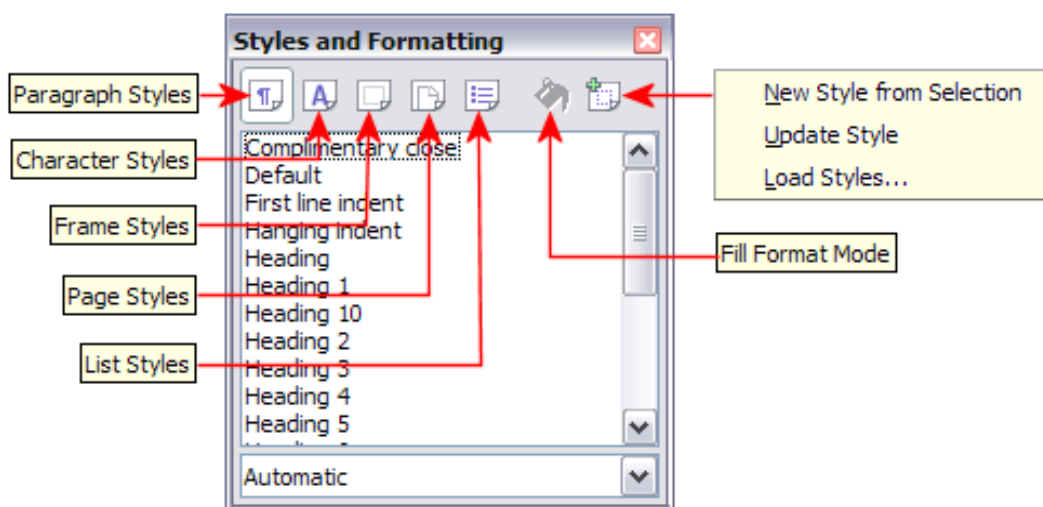



Figure 46: The Styles and Formatting window for Writer, showing paragraph styles

Using Fill Format mode

Use Fill Format to apply a style to many different areas quickly without having to go back to the Styles and Formatting window and double-click every time. This method is quite useful when you need to format many scattered paragraphs, cells, or other items with the same style.

- 1) Open the Styles and Formatting window and select the style you want to apply.
- 2) Click the **Fill Format mode** icon .
- 3) To apply a paragraph, page, or frame style, hover the mouse over the paragraph, page, or frame and click. To apply a character style, hold down the mouse button while selecting the characters. Clicking on a word applies the character style for that word. Repeat step 3 until you made all the changes for that style.
- 4) To quit Fill Format mode, click the **Fill Format mode** icon again or press the *Esc* key.

Caution

When this mode is active, a right-click anywhere in the document undoes the last Fill Format action. Be careful not to accidentally right-click and thus undo actions you want to keep.

Using the Apply Style list

After you have used a style at least once in a document, the style name appears on the Apply Style list at the left-hand end of the Formatting toolbar, next to the Styles and Formatting icon.

You can open this list and click once on the style you want, or you can use the up and down arrow keys to move through the list and then press *Enter* to apply the highlighted style.

Tip

Select **More...** at the bottom of the list to open the Styles and Formatting window.

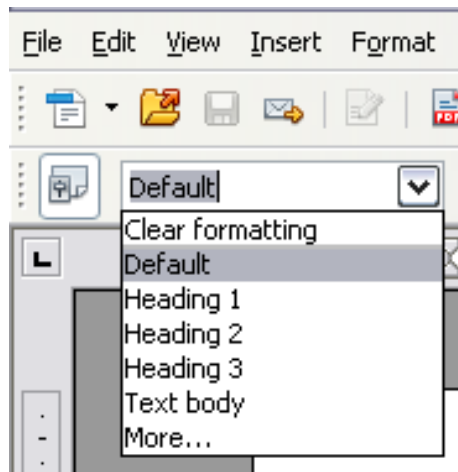

Figure 47: The Apply Style list on the Formatting toolbar

Using keyboard shortcuts

Some keyboard shortcuts for applying styles are predefined. For example, in Writer *Control+0* applies the *Text body* style, *Control+1* applies the *Heading 1* style, and *Control+2* applies the *Heading 2* style. You can modify these shortcuts and create your own; see Chapter 14 (Customizing OpenOffice.org) for instructions.

Modifying styles

OpenOffice.org provides several ways to modify styles (both the predefined styles and custom styles that you create):

- Changing a style using the Style dialog
- Updating a style from a selection
- Use AutoUpdate (paragraph and frame styles only)
- Load or copy styles from another document or template

Tip

Any changes you make to a style are effective only in the current document. To change styles in more than one document, you need to change the template or copy the styles into the other documents as described on page 62.

Changing a style using the Style dialog

To change an existing style using the Style dialog, right-click on the required style in the Styles and Formatting window and select **Modify** from the pop-up menu.

The Style dialog displayed depends on the type of style selected. Each style dialog has several tabs. See the chapters on styles in the user guides for details.

Updating a style from a selection

To update a style from a selection:

- 1) Open the Styles and Formatting window.
- 2) In the document, select an item that has the format you want to adopt as a style.

Caution



Make sure that there are unique properties in this paragraph. For example, if there are two different font sizes or font styles, that particular property will remain the same as before.

- 3) In the Styles and Formatting window, select the style you want to update (single-click, not double-click), then long-click on the arrow next to the **New Style from Selection** icon and click on **Update Style**.

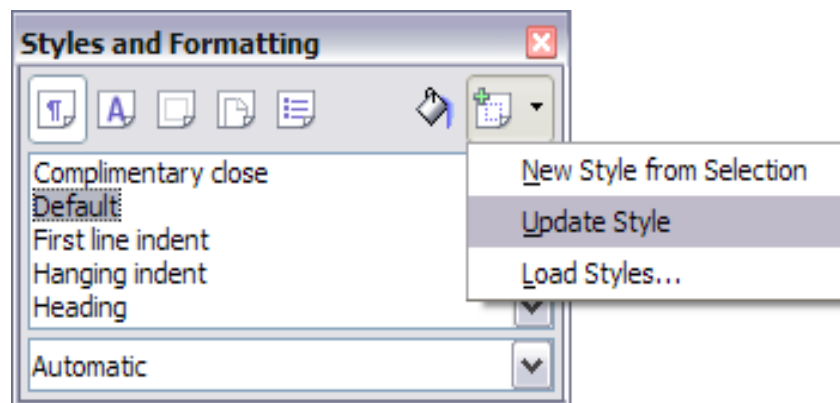

Figure 48: Updating a style from a selection

Using AutoUpdate

AutoUpdate applies to paragraph and frame styles only. If the AutoUpdate option is selected on the Organizer page of the Paragraph Style or Frame Style dialog, applying direct formatting to a paragraph or frame using this style in your document automatically updates the style itself.

Tip

If you are in the habit of manually overriding styles in your document, be sure that AutoUpdate is **not** enabled.

Updating styles from a document or template

You can update styles by copying or loading them from a template or another document. See “Copying and moving styles” on page 62.

Creating new (custom) styles

You may want to add some new styles. You can do this in two ways:

- Creating a new style using the Style dialog
- Creating a new style from a selection

Creating a new style using the Style dialog

To create a new style using the Style dialog, right-click in the Styles and Formatting window and select **New** from the pop-up menu.

If you want your new style to be linked with an existing style, first select that style and then right-click and select **New**.

If you link styles, then when you change the base style (for example, by changing the font from Times to Helvetica), all the linked styles will change as well. Sometimes this is exactly what you want; other times you do not want the changes to apply to all the linked styles. It pays to plan ahead.

The dialogs and choices are the same for defining new styles and for modifying existing styles. See the chapters on styles in the user guides for details.

Creating a new style from a selection

You can create a new style by copying an existing manual format. This new style applies only to this document; it will not be saved in the template.

- 1) Open the Styles and Formatting window and choose the type of style you want to create.
- 2) In the document, select the item you want to save as a style.
- 3) In the Styles and Formatting window, click on the **New Style from Selection** icon.
- 4) In the Create Style dialog, type a name for the new style. The list shows the names of existing custom styles of the selected type. Click **OK** to save the new style.

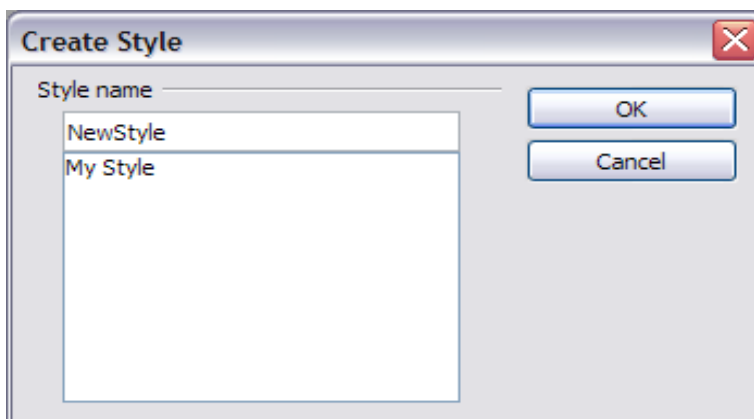

Figure 49: Naming a new style created from a selection

Dragging and dropping to create a style

You can drag and drop a text selection into the Styles and Formatting window to create a new style.

Writer

Select some text and drag it to the Styles and Formatting window. If Paragraph Styles are active, the paragraph style will be added to the list. If Character Styles are active, the character style will be added to the list.

Calc

Drag a cell selection to the Styles and Formatting window to create cell styles.

Draw/Impress

Select and drag drawing objects to the Styles and Formatting window to create graphics styles.

Copying and moving styles

You can copy or move styles from one template or document into another template or document, in two ways:

- Using the Template Management dialog
- Loading styles from a template or document

Using the Template Management dialog

To copy or move styles using the Template Management dialog:

- 1) Click **File > Templates > Organize**.
- 2) In the Template Management dialog (Figure 50), set the lists at the bottom to either Templates or Documents, as needed. The default is Templates on the left and Documents on the right.

Tip To copy styles from a file that is not open, click the **File** button. When you return to this dialog, both lists show the selected file as well as all the currently open documents.

- 3) Open the folders and find the templates from and to which you want to copy. Double-click on the name of the template or document, and then double-click the Styles icon to show the list of individual styles (Figure 51).
- 4) To *copy* a style, hold down the *Ctrl* key and drag the name of the style from one list to the other.

Caution



If you do not hold down the *Control* key when dragging, the style will be moved from one list to the other. The style will be deleted from the list you are dragging it from.

- 5) Repeat for each style you want to copy. If the receiving template or document has many styles, you may not see any change unless you scroll down in the list. When you are finished, click **Close**.

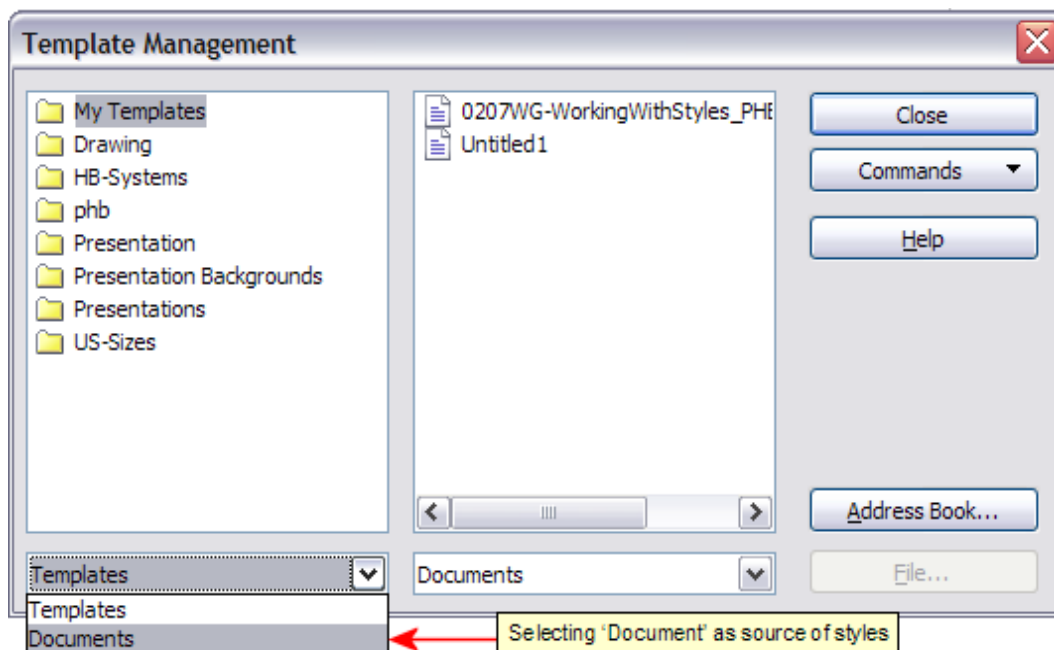

Figure 50: Choosing to copy styles from a document, not a template

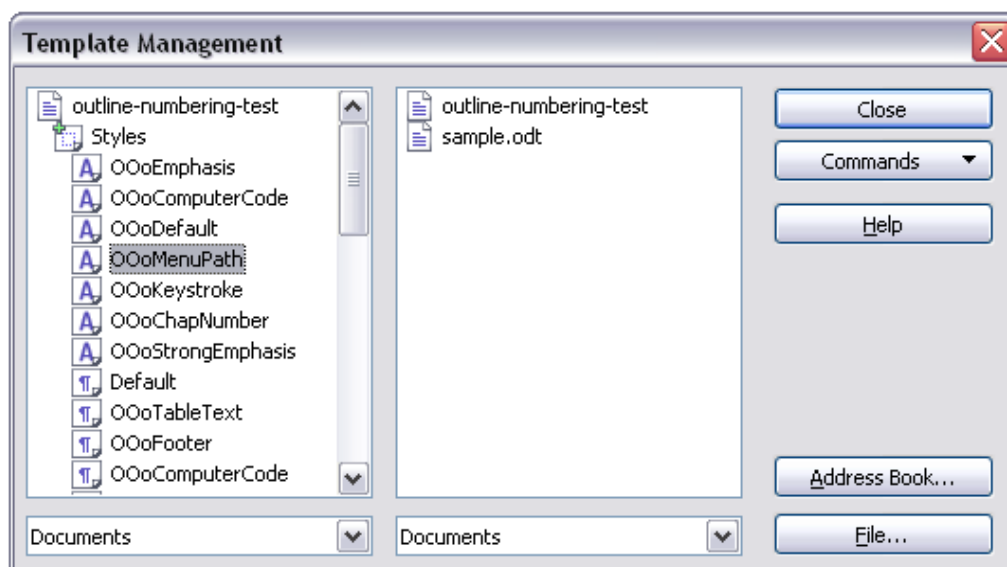

Figure 51: Copying a style from one document to another

Loading styles from a template or document

You can copy styles by loading them from a template or another document:

- 1) Open the document you want to copy styles into.
- 2) In the Styles and Formatting window, long-click on the arrow next to the **New Style from Selection** icon, and then click on **Load Styles** (see Figure 48).
- 3) On the Load Styles dialog (Figure 52), find and select the template you want to copy styles from.

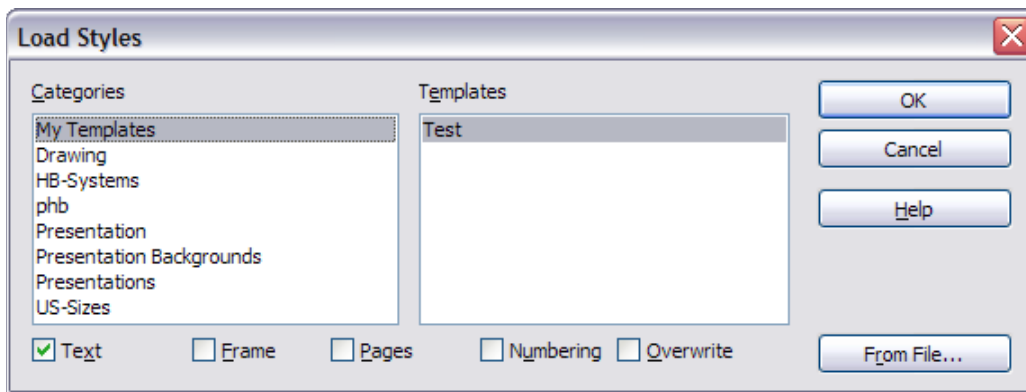

Figure 52. Copying styles from a template into the open document

- 4) Select the categories of styles to be copied. Select **Overwrite** if you want the styles being copied to replace any styles of the same names in the document you are copying them into.
- 5) Click **OK** to copy the styles. You will not see any change on screen.

Note

To copy the styles from another document, click the **From File** button to open a window from which you can select the required document.

Caution



If your document has a table of contents, and if you have used custom styles for headings, the heading levels associated with outline levels (in **Tools > Outline Numbering**) will revert to the defaults of Heading 1, Heading 2, and so on when you load styles this way. You will need to change these back to your custom heading styles. This is a bug.

Deleting styles

You cannot remove (delete) any of OOO's predefined styles from a document or template, even if they are not in use.

You can remove any user-defined (custom) styles; but before you do, you should make sure the styles are not in use. If an unwanted style is in use, you will want to replace it with a substitute style.

To delete unwanted styles, right-click on them (one at a time) in the Styles and Formatting window and click **Delete** on the pop-up menu.

If the style is in use, you receive a warning message.

Caution





Make sure the style is not in use before deletion. Otherwise, all objects with that style will return to the default style and retain their formatting as manual formatting. This can be a problem in a long document.

If the style is not in use, you receive a confirmation message; click **Yes**.

Using a template to create a document

To use a template to create a document:

- 1) From the main menu, choose **File > New > Templates and Documents**. The Templates and Documents dialog opens.
- 2) In the box on the left, click the **Templates** icon if it is not already selected. A list of template folders appears in the center box.
- 3) Double-click the folder that contains the template that you want to use. A list of all the templates contained in that folder appears in the center box.
- 4) Select the template that you want to use. You can preview the selected template or view the template's properties:
 - To preview the template, click the **Preview** icon . A preview of the template appears in the box on the right.
 - To view the template's properties, click the **Document Properties** icon . The template's properties appear in the box on the right.
- 5) Click **Open**. The Templates and Documents dialog closes and a new document based on the selected template opens in OOO. You can then edit and save the new document just as you would any other document.

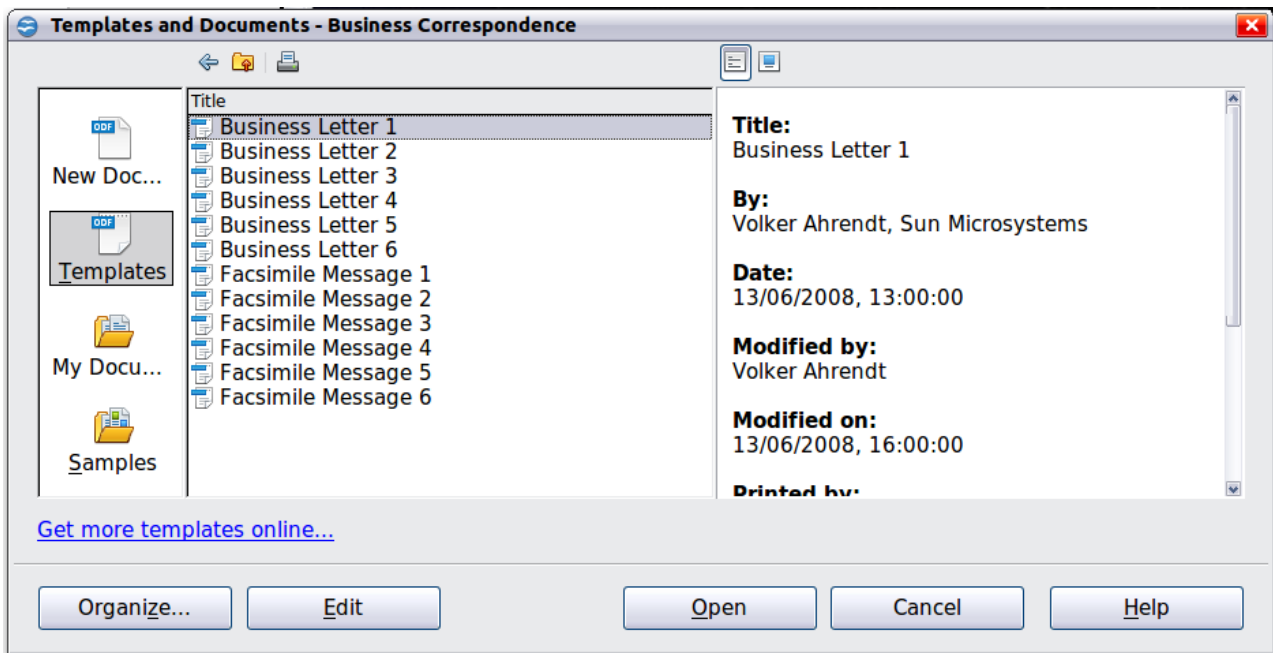

Figure 53: Templates and Documents window

Creating a template

You can create your own templates in two ways: from a document, and using a wizard.

Creating a template from a document

To create a template from a document:

- 1) Open a new or existing document of the type you want to make into a template (text document, spreadsheet, drawing, presentation).
- 2) Add the content and styles that you want.
- 3) From the main menu, choose **File > Templates > Save**. The Templates dialog opens (see Figure 54).
- 4) In the **New template** field, type a name for the new template.
- 5) In the **Categories** list, click the category to which you want to assign the template. The category you choose has no effect on the template itself; it is simply the folder in which you save the template. Choosing an appropriate category makes it easier to find the template when you want to use it. For example, you might save Impress templates under the **Presentations** category.

To learn more about template folders, see “Organizing templates” on page 72.

- 6) Click **OK** to save the new template.

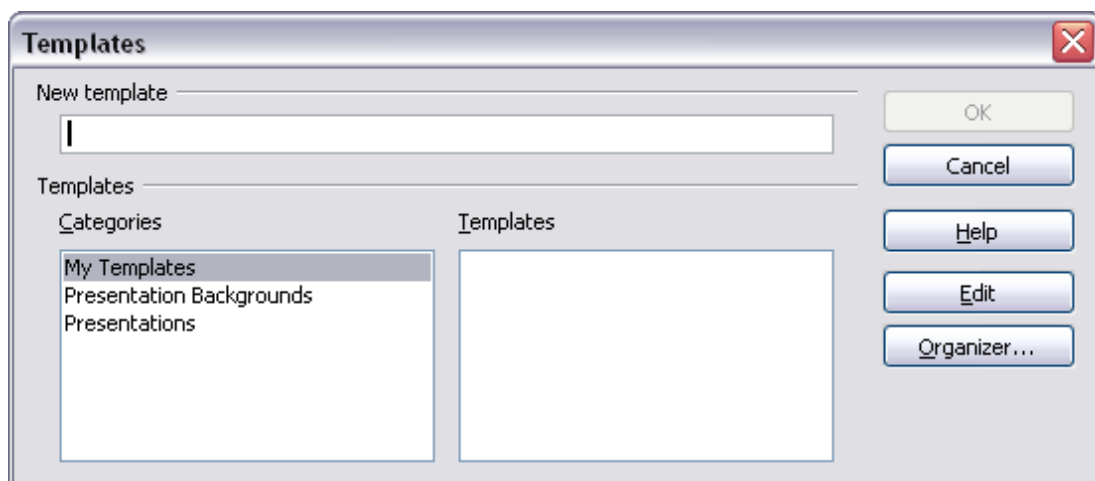

Figure 54: Saving a new template

Any settings that can be added to or modified in a document can be saved in a template. For example, below are some of the settings (although not a full list) that can be included in a Writer document and then saved as a template for later use:

- Printer settings: which printer, single sided / double sided, and paper size, and so on
- Styles to be used, including character, page, frame, numbering and paragraph styles
- Format and settings regarding indexes, tables, bibliographies, table of contents

Templates can also contain predefined text, saving you from having to type it every time you create a new document. For example, a letter template may contain your name, address and salutation.

You can also save menu and toolbar customizations in templates; see Chapter 14 (Customizing OpenOffice.org) for more information.

Creating a template using a wizard

You can use wizards to create templates for letters, faxes, agendas, presentations, and Web pages.

For example, the Fax Wizard guides you through the following choices:

- Type of fax (business or personal)
- Document elements like the date, subject line (business fax), salutation, and complementary close
- Options for sender and recipient information (business fax)
- Text to include in the footer (business fax)

To create a template using a wizard:

- 1) From the main menu, choose **File > Wizards > [type of template required]**.

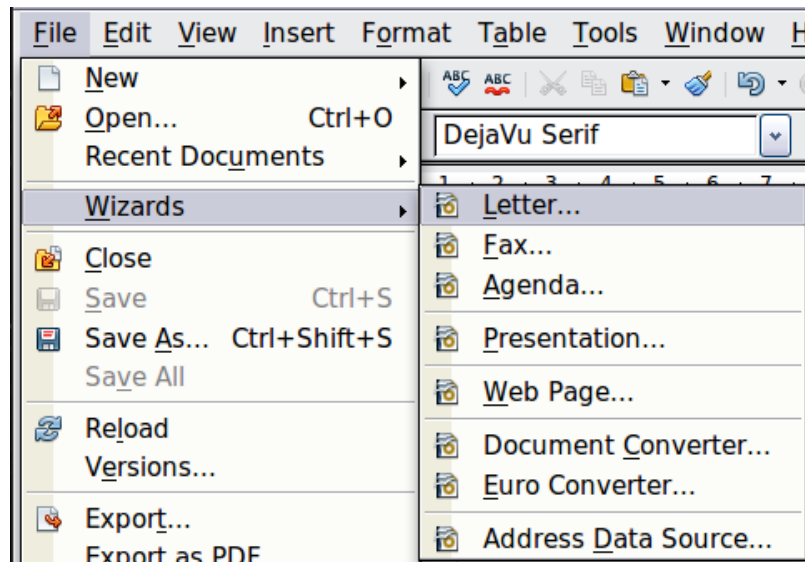

Figure 55. Creating a template using a wizard

- 2) Follow the instructions on the pages of the wizard. This process is slightly different for each type of template, but the format is very similar.
- 3) In the last section of the wizard, you can specify the name and location for saving the template. The default location is your user templates directory, but you can choose a different location if you prefer.
- 4) Finally, you have the option of creating a new document from your template immediately, or manually changing the template. For future documents, you can re-use the template created by the wizard, just as you would use any other template.

Editing a template

You can edit a template's styles and content, and then, if you wish, you can reapply the template's styles to documents that were created from that template. (Note that you can only reapply styles. You cannot reapply content.)

To edit a template:

- 1) From the main menu, choose **File > Templates > Edit**. A standard file browser window opens.
- 2) Select the template that you want to edit.
- 3) Edit the template just as you would any other document. To save your changes, choose **File > Save** from the main menu.

Updating a document from a changed template

The next time you open a document that was created from the changed template, the following message appears.

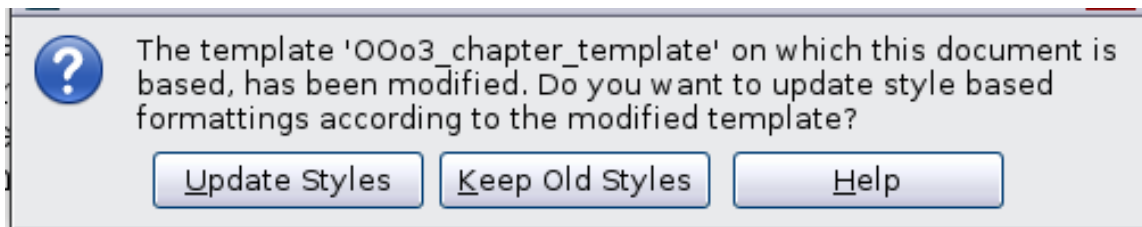

Figure 56. Update styles message

Click **Update Styles** to apply the template's changed styles to the document. Click **No** if you do not want to apply the template's changed styles to the document (but see Caution notice below).

Caution



If you choose **Keep Old Styles** in the message box shown in Figure 56, that message will not appear again the next time you open the document after changing the template it is based on. You will not get another chance to update the styles from the template, although you can use the macro given in the Note below to re-enable this feature.

If you are using Writer, you can also use the Template Changer extension (see page 71) to reactivate the template.

Note

To re-enable updating from a template:

- 1) Use **Tools > Macros > Organize Macros > OpenOffice.org Basic**. Select the document from the list, click the expansion symbol (+ or triangle), and select Standard. If Standard has an expansion symbol beside it, click that and select a module.
- 2) If the **Edit** button is active, click it. If the Edit button is not active, click **New**.
- 3) In the Basic window, enter the following:

```
Sub FixDocV3
  ' set UpdateFromTemplate
  oDocSettings = ThisComponent.createInstance( _
    "com.sun.star.document.Settings" )
  oDocSettings.UpdateFromTemplate = True
End Sub 'FixDocV3
```
- 4) Click the **Run BASIC** icon, then close the Basic window.
- 5) Save the document.

Next time when you open this document you will have the update from template feature back.

Adding templates using the Extension Manager

The Extension Manager provides an easy way to install collections of templates, graphics, macros, or other add-ins that have been “packaged” into files with a .OXT extension. See Chapter 14 (Customizing OpenOffice.org) for more about the Extension Manager.

This Web page lists many of the available extensions:
<http://extensions.services.openoffice.org/>.

To install an extension, follow these steps:

- 1) Download an extension package and save it anywhere on your computer.
- 2) In OoO, select **Tools > Extension Manager** from the menu bar. In the Extension Manager dialog, click **Add**.
- 3) A file browser window opens. Find and select the package of templates you want to install and click **Open**. The package begins installing. You may be asked to accept a license agreement.
- 4) When the package installation is complete, the templates are available for use through **File > New > Templates and Documents** and the extension is listed in the Extension Manager.

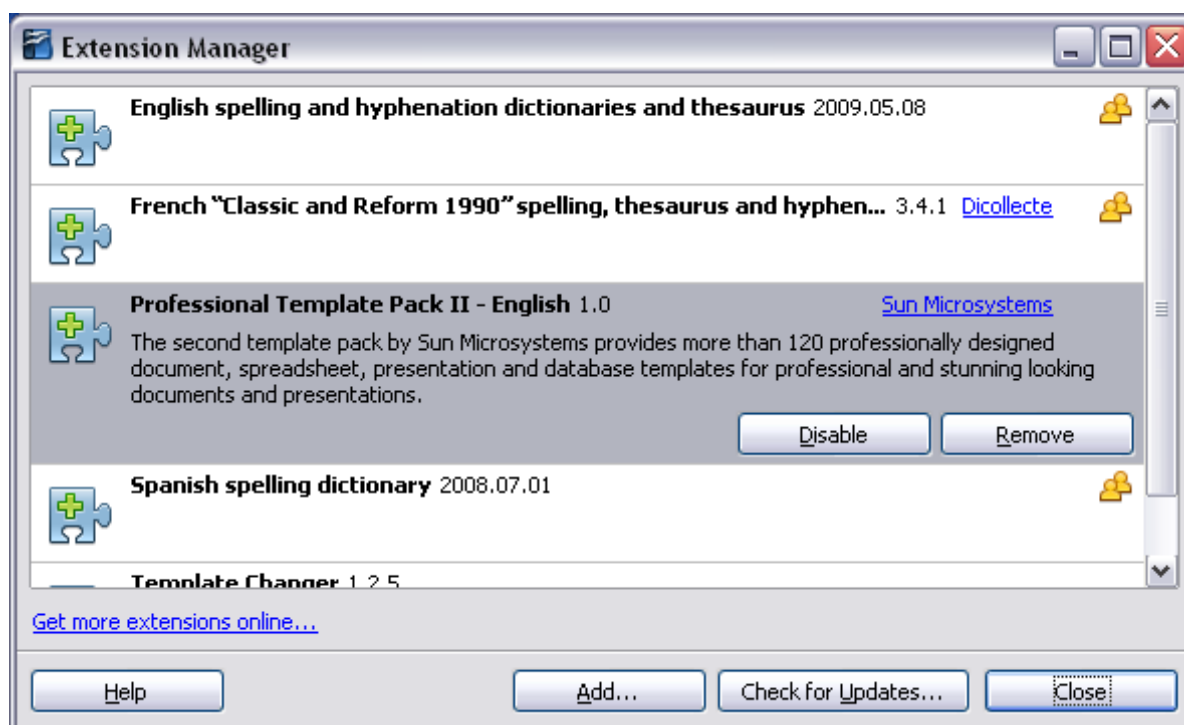

Figure 57: Newly-added package of templates

Setting a default template

If you create a document by choosing **File > New > Text Document** (or **Spreadsheet**, **Presentation**, or **Drawing**) from the main menu, Oo creates the document from the Default template for that type of document. You can, however, set a custom template to be the default. You can reset the default later if you choose.

Setting a custom template as the default

You can set any template to be the default, as long as it is in one of the folders displayed in the Template Management dialog.

To set a custom template as the default:

- 1) From the main menu, choose **File > Templates > Organize**. The Template Management dialog opens.
- 2) In the box on the left, select the folder containing the template that you want to set as the default, then select the template.
- 3) Click the **Commands** button and choose **Set As Default Template** from the drop-down menu.

The next time that you create a document by choosing **File > New**, the document will be created from this template.

Although many important settings can be changed in the Options dialog (see Chapter 2), for example default fonts and page size, more advanced settings (such as page margins) can only be changed by replacing the default template with a new one.

Resetting the default template

To re-enable OOO's Default template for a document type as the default:

- 1) In the Template Management dialog, click any folder in the box on the left.
- 2) Click the **Commands** button and choose **Reset Default Template** from the drop-down menu.

The next time that you create a document by choosing **File > New**, the document will be created from OOO's Default template for that document type.

Associating a document with a different template

At times you might want to associate a document with a different template, or perhaps you are working with a document that did not start from a template.

One of the major advantages of using templates is the ease of updating styles in more than one document, as described on page 68. If you update styles by loading a new set of styles from a different template (as described on page 63), the document has no association with the template from which the styles were loaded—so you cannot use this method. What you need to do is associate the document with the different template.

You can do this in two ways. In both cases, for best results the names of styles should be the same in the existing document and the new template. If they are not, you will need to use Search and Replace to replace old styles with new ones. See Chapter 4 (Getting Started with Writer) for more about replacing styles using Search and Replace.

Method 1

This method includes any graphics and wording (such as legal notices) that exists in the new template, as well as including styles. If you do not want this material, you need to delete it.

- 1) Use **File > New > Templates and Documents**. Choose the template you want. If the template has unwanted text or graphics in it, delete them.
- 2) Open the document you want to change. (It opens in a new window.) Press *Control*+*A* to select everything in the document. Paste into the blank document created in step 1.
- 3) Update the table of contents, if there is one. Save the file.

Method 2 (Writer only)

This method does not include any graphics or text from the new template; it simply includes styles from the new template and establishes an association between the template and the document.

- 1) Download the Template Changer extension from <http://extensions.services.openoffice.org/> and install it as described on page 69.
- 2) Close and reopen OpenOffice.org. Now the **File > Templates** menu has two new choices in Writer: *Assign Template (current document)* and *Assign Template (folder)*. In Calc, Impress, and Draw, only the *Assign Template (folder)* choice is available.
- 3) Open the document whose template you want to change. Choose **File > Templates > Assign Template (current document)**.

- 4) In the Select Template window, find and select the required template and click **Open**.
- 5) Save the document. If you now look in **File > Properties**, you will see the new template listed at the bottom of the General page.

Organizing templates

OOo can only use templates that are in OOo template folders. You can create new OOo template folders and use them to organize your templates. For example, you might have one template folder for report templates and another for letter templates. You can also import and export templates.

To begin, choose **File > Templates > Organize** from the main menu. The Template Management dialog opens.

Note

All the actions made by the **Commands** button in the Template Management dialog can be made as well by right-clicking on the templates or the folders.

Creating a template folder

To create a template folder:

- 1) In the Template Management dialog, click any folder.
- 2) Click the **Commands** button and choose **New** from the drop-down menu. A new folder called *Untitled* appears.
- 3) Type a name for the new folder, and then press *Enter*. OOo saves the folder with the name that you entered.

Deleting a template folder

You cannot delete template folders supplied with OOo or installed using the Extension Manager; you can only delete template folders that you have created.

To delete a template folder that you have created:

- 1) In the Template Management dialog, select the folder that you want to delete.
- 2) Click the **Commands** button and choose **Delete** from the drop-down menu. A message box appears and asks you to confirm the deletion. Click **Yes**.

Moving a template

To move a template from one template folder to another template folder:

- 1) In the Template Management dialog, double-click the folder that contains the template you want to move. A list of the templates contained in that folder appears underneath the folder name.
- 2) Click the template that you want to move and drag it to the desired folder. If you do not have the authority to delete templates from the source folder, this action *copies* the template instead of moving it.

Deleting a template

You cannot delete templates supplied with OOO or installed using the Extension Manager; you can only delete templates that you have created or imported.

To delete a template:

- 1) In the Template Management dialog, double-click the folder that contains the template you want to delete. A list of the templates contained in that folder appears underneath the folder name.
- 2) Click the template that you want to delete.
- 3) Click the **Commands** button and choose **Delete** from the drop-down menu. A message box appears and asks you to confirm the deletion. Click **Yes**.

Importing a template

If the template that you want to use is in a different location, you must import it into an OOO template folder.

To import a template into a template folder:

- 1) In the Template Management dialog, select the folder into which you want to import the template.
- 2) Click the **Commands** button and choose **Import Template** from the drop-down menu. A standard file browser window opens.
- 3) Find and select the template that you want to import and click **Open**. The file browser window closes and the template appears in the selected folder.
- 4) If you want, type a new name for the template, and then press *Enter*.

Exporting a template

To export a template from a template folder to another location:

- 1) In the Template Management dialog, double-click the folder that contains the template you want to export. A list of the templates contained in that folder appears underneath the folder name.
- 2) Click the template that you want to export.
- 3) Click the **Commands** button and choose **Export Template** from the drop-down menu. The Save As window opens.
- 4) Find the folder into which you want to export the template and click **Save**.

Examples of style use

The following examples of common use of page and paragraph styles are taken from Writer. There are many other ways to use styles; see the guides for the various components for details.

Defining a different first page for a document

Many documents, such as letters and reports, have a first page that is different from the other pages in the document. For example, the first page of a letterhead typically has a different header, or the first page of a report might have no header or footer, while the other pages do. With OOO, you can define the *page style* for the first page and specify the style for the following pages to be applied automatically.

As an example, we can use the *First Page* and *Default* page styles that come with OOo. Figure 58 shows what we want to happen: the first page is to be followed by the default page, and all the following pages are to be in the *Default* page style. Details are in Chapter 4 (Formatting Pages) in the *Writer Guide*.

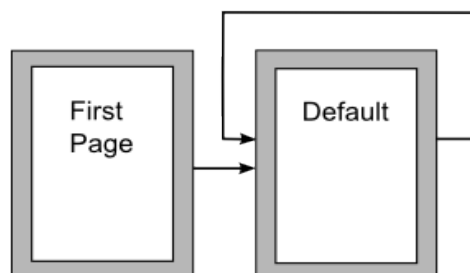

Figure 58: Flow of page styles

Dividing a document into chapters

In a similar way, you can divide a document into chapters. Each chapter might start with the *First Page* style, with the following pages using the *Default* page style, as above. At the end of the chapter, insert a manual page break and specify the next page to have the *First Page* style to start the next chapter, as shown in Figure 59.

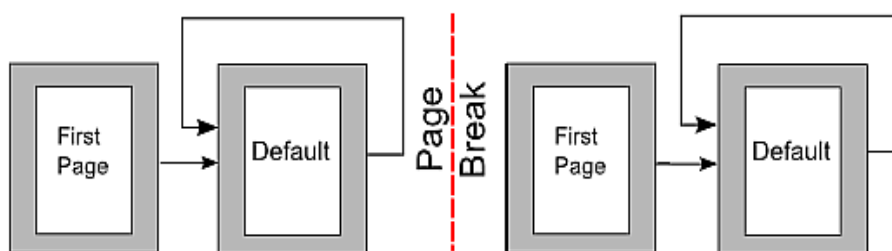

Figure 59: Dividing a document into chapters using page styles

Changing page orientation within a document

A Writer document can contain pages in more than one orientation. A common scenario is to have a landscape page in the middle of a document, whereas the other pages are in a portrait orientation. This can also be done with page breaks and page styles.

Different headers on right and left pages

Page styles can be set up to have the facing left and right pages *mirrored* or only right (first pages of chapters are often defined to be right-page only) or only left. When you insert a header on a page style set up for mirrored pages or right-and-left pages, you can have the contents of the header be the same on all pages or be different on the right and left pages. For example, you can put the page number on the left-hand edge of the left pages and on the right-hand edge of the right pages, put the document title on the right-hand page only, or make other changes.

Controlling page breaks automatically

Writer automatically flows text from one page to the next. If you do not like the default settings, you can change them. For example, you can require a paragraph to start on a new page or column and specify the style of the new page. A typical use is for chapter titles to always start on a new right-hand (odd-numbered) page.

Compiling an automatic table of contents

To compile an automatic table of contents, first apply styles to the headings you want to appear in the contents list, then use **Tools > Outline Numbering** to tell Writer which styles go with which level in the table of contents. See Chapter 4 for more information.

Defining a sequence of styles

You can set up one paragraph style so that when you press *Enter* at the end of that paragraph, the following paragraph automatically has the style you wish applied to it. For example, you could define a *Heading 1* paragraph to be followed by a *Text Body* paragraph. A more complex example would be: *Title* followed by *Author* followed by *Abstract* followed by *Heading 1* followed by *Text Body*. By setting up these sequences, you can avoid manually applying styles in most cases.

Chapter 4

Getting Started with Writer

Word Processing with OpenOffice.org

What is Writer?

Writer is the word processor component of OpenOffice.org (OOo). In addition to the usual features of a word processor (spelling check, thesaurus, hyphenation, autocorrect, find and replace, automatic generation of tables of contents and indexes, mail merge and others), Writer provides these important features:

- Templates and styles (see Chapter 3)
- Page layout methods, including frames, columns, and tables
- Embedding or linking of graphics, spreadsheets, and other objects
- Built-in drawing tools
- Master documents—to group a collection of documents into a single document
- Change tracking during revisions
- Database integration, including a bibliography database
- Export to PDF, including bookmarks (see Chapter 10)
- And many more

These features are covered in detail in the *Writer Guide*.

The Writer interface

The main Writer workspace is shown in Figure 60. The menus and toolbars are described in Chapter 1 (Introducing OpenOffice.org).

Some other features of the Writer interface are covered in this chapter.

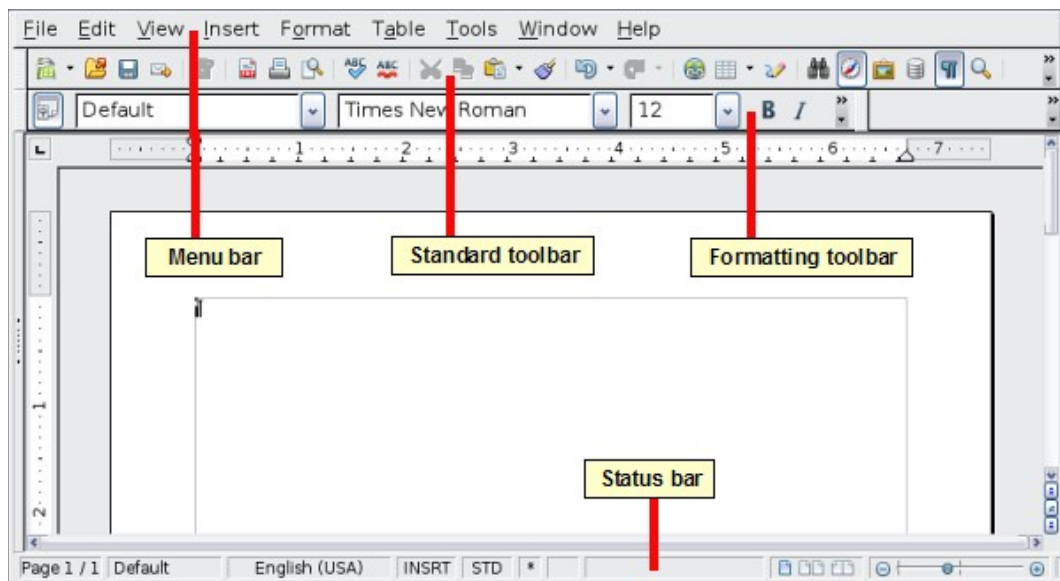

Figure 60: The main Writer workspace in Print Layout view

Status bar

The Writer status bar provides information about the document and convenient ways to quickly change some document features.

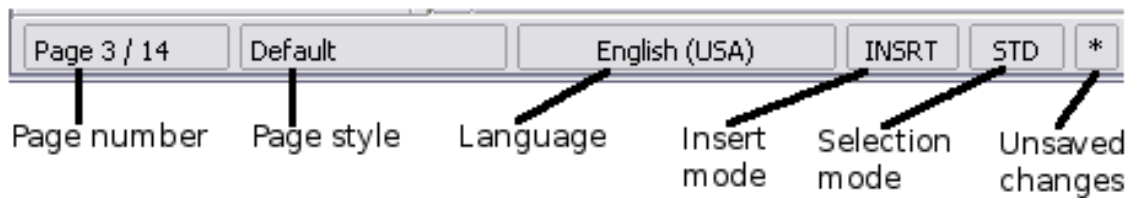

Figure 61: Left end of status bar

Page number

Shows the current page number, the sequence number of the current page (if different), and the total number of pages in the document. For example, if you restarted page numbering at 1 on the third page, its page number is 1 and its sequence number is 3.

If any bookmarks have been defined in the document, a right-click on this field pops up a list of bookmarks; click on the required one.

To jump to a specific page in the document, double-click on this field. The Navigator opens. Click in the Page Number field and type the *sequence* number of the required page. After a brief delay, the display jumps to the selected page.

Page style

Shows the style of the current page. To change the page style, right-click on this field. A list of page styles pops up; choose a different style by clicking on it.

To edit the current page style, double-click on this field. The Page Style dialog opens.

Language

Shows the language for the selected text.

Click to open a menu where you can choose another language for the selected text or for the paragraph where the cursor is located. You can also choose **None (Do not check spelling)** to exclude the text from a spelling check or choose **More...** to open the Character dialog.

Insert mode

Click to toggle between *Insert* and *Overwrite* modes when typing.

Selection mode

Click to toggle between STD (*Standard*), EXT (*Extend*), ADD (*Add*) and BLK (*Block*) selection. EXT is an alternative to *Shift+click* when selecting text. See "Working with text" on page 82 for more information about ADD and BLK.

Unsaved changes

An asterisk (*) appears here if changes to the document have not been saved.

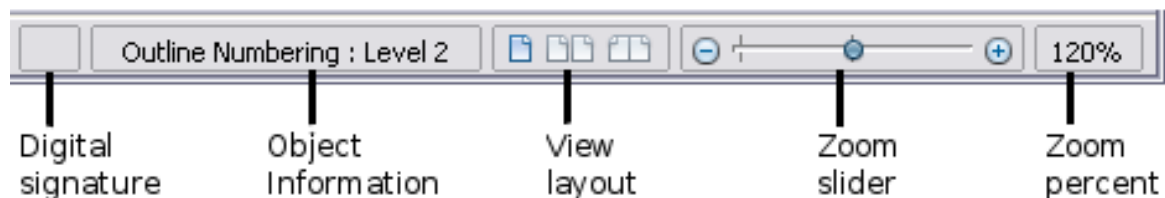

Figure 62: Right end of status bar

Digital signature

If the document has been digitally signed, an icon  shows here. You can double-click the icon to view the certificate.

Section or object information

When the cursor is on a section, heading, or list item, or when an object (such as a picture or table) is selected, information about that item appears in this field. Double-clicking in this area opens a relevant dialog. For details, consult the Help or the *Writer Guide*.

View layout

Click an icon to change between single page, side-by-side, and book layout views. You can edit the document in any view.

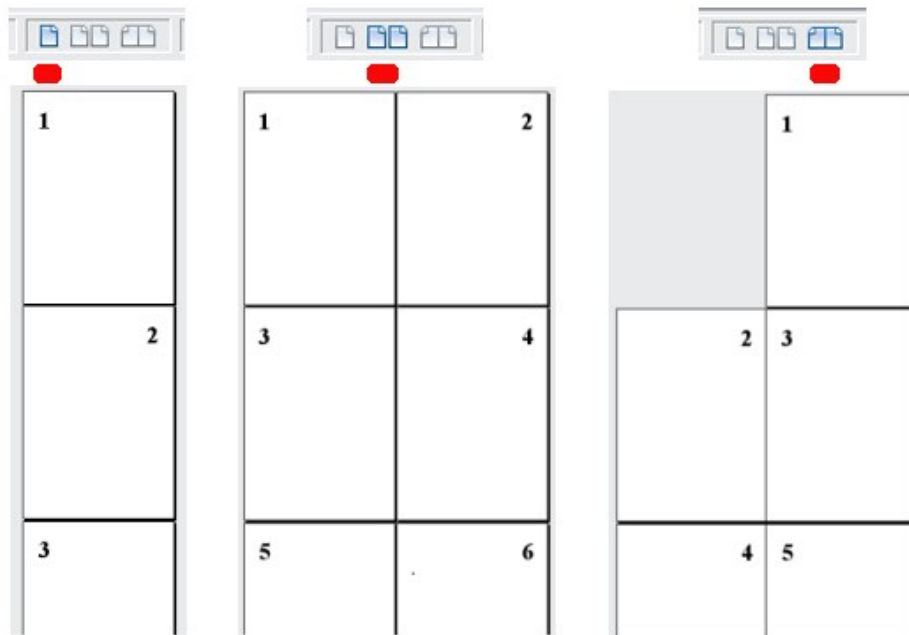
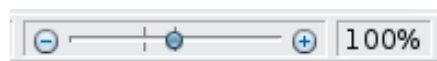

Figure 63: View layouts: single, side-by-side, book.

Zoom

To change the view magnification, drag the Zoom slider, or click on the + and - signs, or right-click on the zoom level percent to pop up a list of magnification values from which to choose. Zoom interacts with the selected view layout to determine how many pages are visible in the document window.



Changing document views

Writer has several ways to view a document: Print Layout, Web Layout, and Full Screen. To access these and other choices, go to the **View** menu and click on the required view. (When in Full Screen view, press the *Esc* key to return to either Print or Web Layout view.)

When in Print Layout, you can use both the Zoom slider and the View Layout icons on the status bar. In Web Layout, you can use the Zoom slider.

You can also choose **View > Zoom** from the menu bar to display the Zoom & View Layout dialog, where you can set the same options as on the Status bar. In Web Layout view, most of the choices are not available.

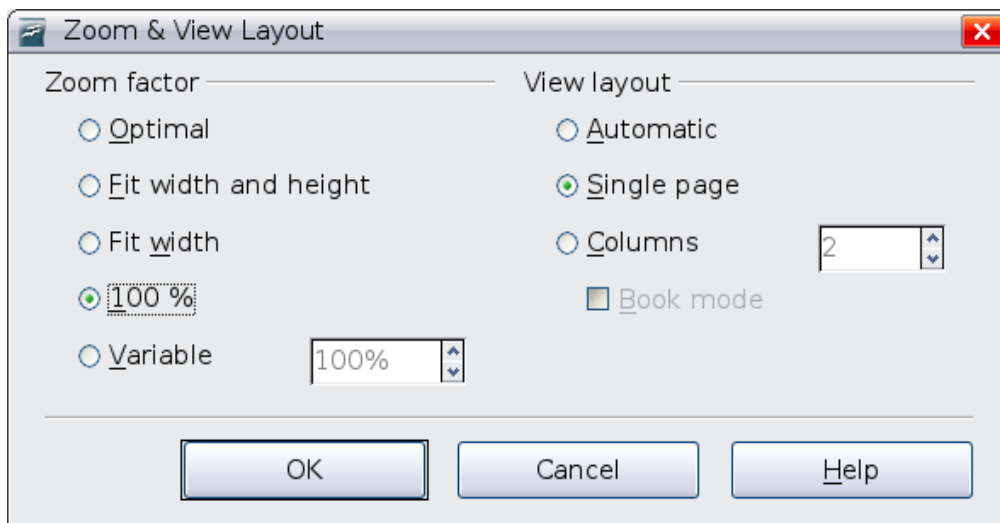

Figure 64: Choosing Zoom and View Layout options.

Moving quickly through a document

In addition to the navigation features of the Status bar (described above), you can use the main Navigator window and the Navigation toolbar as described in Chapter 1 (Introducing OpenOffice.org).

In Writer, you can also display the Navigation toolbar by clicking on the small Navigation icon near the lower right-hand corner of the window below the vertical scroll bar, as shown in Figure 65.

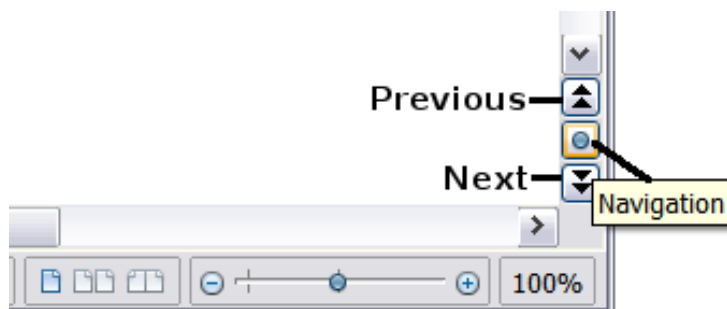

Figure 65: Navigation icons

The Navigation toolbar (Figure 66) shows icons for all the object types shown in the Navigator, plus some extras (for example, the results of a **Find** command).

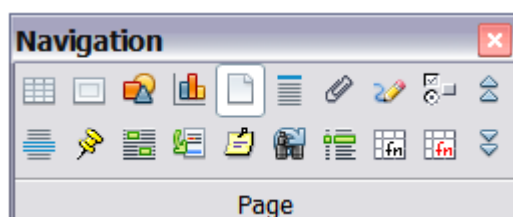

Figure 66: Navigation toolbar

Click an icon to select that object type. Now all the **Previous** and **Next** icons (in the Navigator itself, in the Navigation Toolbar, and on the scroll bar) will jump to the next object of the selected type. This is particularly helpful for finding items like index entries, which can be difficult to see in the text. The names of the icons (shown in the tooltips) change to match the selected category; for example, **Next Graphic**, **Next Bookmark**, or **Continue search forward**.

For more uses of the Navigator in Writer, see the *Writer Guide*.

Working with documents

Chapter 1 (Introducing OpenOffice.org) includes instructions on starting new documents, opening existing documents, and saving documents. Chapter 3 (Using Styles and Templates) covers how to create a document from a template.

Saving as a Microsoft Word file

If you need to exchange files with users of Microsoft Word, they may not know how to open and save .odt files. Microsoft Word 2007 with Service Pack 2 (SP2) can do this. Users of Word 2003, XP, and 2000 can buy a plug-in from Oracle Corp or search on the Web for the free OpenDocument Format (ODF) plugin from Sun Microsystems.

Some users of Microsoft Word may be unwilling or unable to receive *.odt files. (Their employer may not allow them to install the plug-in.) In this case, you can save a document as a Microsoft Word file.

- 1) **Important**—First save your document in the file format used by OOO Writer (.odt). If you do not, any changes you made since the last time you saved will appear only in the Microsoft Word version of the document.
- 2) Then choose **File > Save As**. On the Save As dialog, in the **File type** (or **Save as type**) drop-down menu, select the type of Word format you need. Click **Save**.

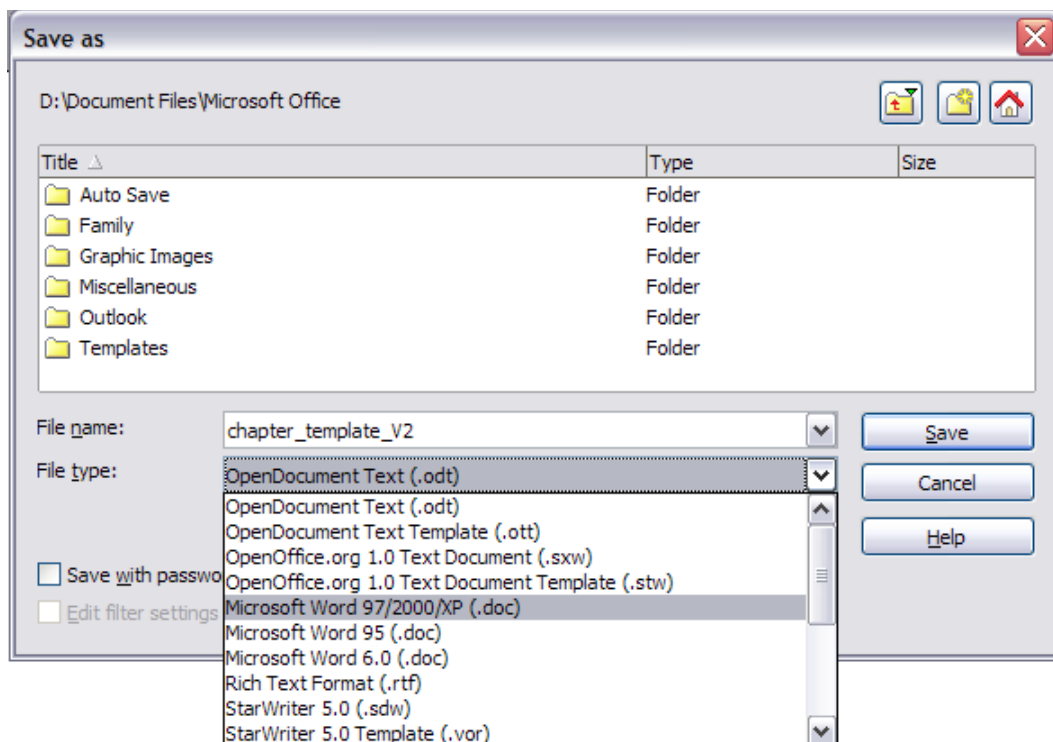

Figure 67. Saving a file in Microsoft Word format

From this point on, *all changes you make to the document will occur only in the Microsoft Word document*. You have changed the name and file type of your document. If you want to go back to working with the .odt version of your document, you must open it again.

Tip To have OOO save documents by default in the Microsoft Word file format, go to **Tools > Options > Load/Save**. See “Choosing options for loading and saving documents” in Chapter 2 (Setting up OpenOffice.org).

Working with text

Working with text (selecting, copying, pasting, moving) in Writer is similar to working with text in any other program. OOO also has some convenient ways to select items that are not next to each other, select a vertical block of text, and paste unformatted text.

Selecting items that are not consecutive

To select nonconsecutive items (as shown in Figure 68) using the mouse:

- 1) Select the first piece of text.
- 2) Hold down the *Control* key and use the mouse to select the next piece of text.
- 3) Repeat as often as needed.

Now you can work with the selected text (copy it, delete it, change the style, or whatever).

Note Macintosh users: substitute the *Command* key when instructions in this chapter say to use the *Control* key.

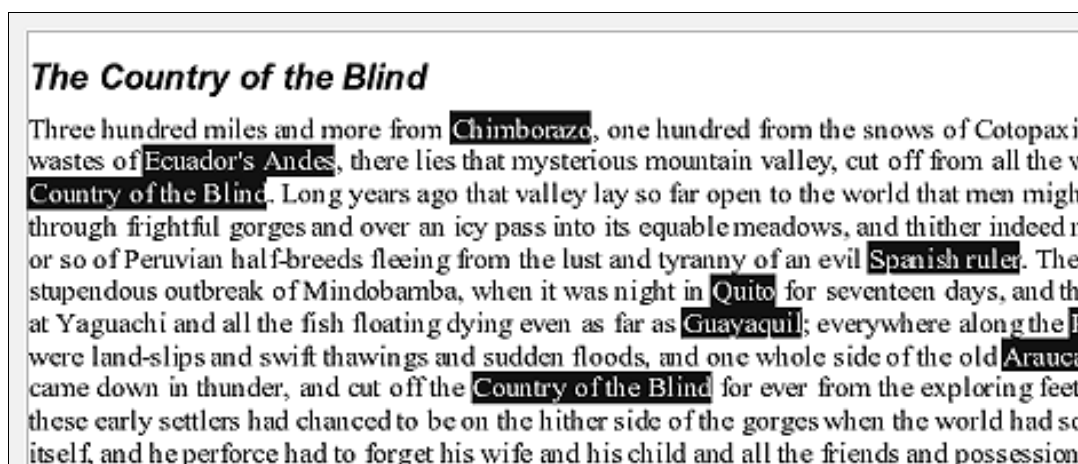

Figure 68: Selecting items that are not next to each other

To select nonconsecutive items using the keyboard:

- 1) Select the first piece of text. (For more information about keyboard selection of text, see the topic “Navigating and selecting with the keyboard” in the Help.)
- 2) Press *Shift+F8*. This puts Writer in “Add” mode. The word ADD appears on the status bar.

- 3) Use the arrow keys to move to the start of the next piece of text to be selected. Hold down the *Shift* key and select the next piece of text.
- 4) Repeat as often as needed.

Now you can work with the selected text.

Press *Esc* to exit from this mode.

Selecting a vertical block of text

You can select a vertical block or “column” of text that is separated by spaces or tabs (as you might see in text pasted from e-mails, program listings, or other sources), using OOO’s block selection mode. To change to block selection mode, use **Edit > Selection Mode > Block Area**, or click several times in the status bar on STD until it changes to BLK.

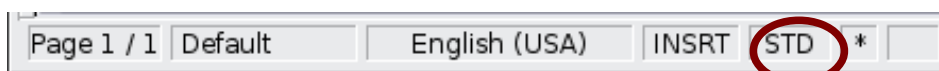

Now highlight the selection, using mouse or keyboard, as shown below.



Figure 69: Selecting a vertical block of text

Cutting, copying, and pasting text

Cutting and copying text in Writer is similar to cutting and copying text in other applications. You can use the mouse or the keyboard for these operations. You can copy or move text within a document, or between documents, by dragging or by using menu selections, icons, or keyboard shortcuts. You can also copy text from other sources such as Web pages and paste it into a Writer document.

To *move* (cut and paste) selected text using the mouse, drag it to the new location and release it. To *copy* selected text, hold down the *Control* key while dragging. The text retains the formatting it had before dragging.

When you paste text, the result depends on the source of the text and how you paste it. If you click on the **Paste** icon, any formatting the text has (such as bold or italics) is retained. Text pasted from Web sites and other sources may also be placed into frames or tables. If you do not like the results, click the **Undo** icon or press *Control+Z*.

To make the pasted text take on the formatting of the surrounding text where it is being pasted, choose either:

- **Edit > Paste Special**, or
- Click the triangle to the right of the **Paste** icon, or
- Click the **Paste** icon without releasing the left mouse button.

Then select **Unformatted text** from the resulting menu.

The range of choices on the Paste Special menu varies depending on the origin and formatting of the text (or other object) to be pasted. See Figure 70 for an example with text on the clipboard.

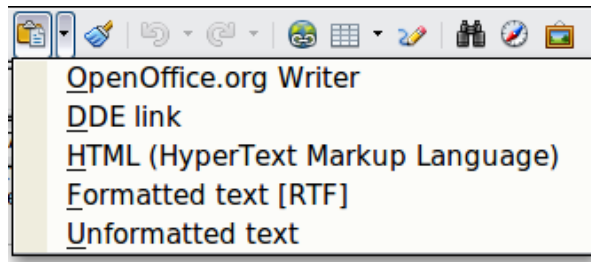

Figure 70: Paste Special menu

Finding and replacing text and formatting

Writer has two ways to find text within a document: the Find toolbar for fast searching and the Find & Replace dialog. In the dialog, you can:

- Find and replace words and phrases
- Use wildcards and regular expressions to fine-tune a search
- Find and replace specific formatting
- Find and replace paragraph styles

If the Find toolbar is not visible, you can display it using **View > Toolbars > Find**.



To display the Find & Replace dialog, use the keyboard shortcut *Control+F* or choose **Edit > Find & Replace** from the menu bar.

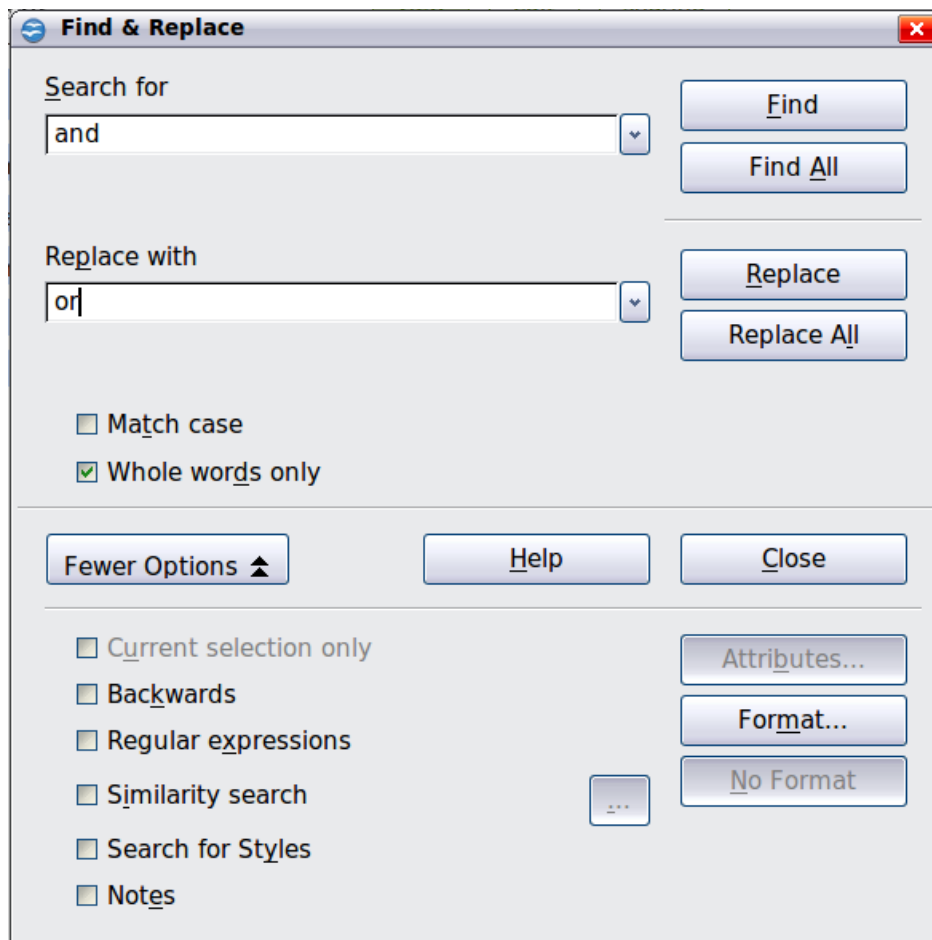

Figure 71: Expanded Find & Replace dialog

- 1) Type the text you want to find in the **Search for** box.
- 2) To replace the text with different text, type the new text in the **Replace with** box.
- 3) You can select various options such as matching the case, matching whole words only, or doing a search for similar words.
- 4) When you have set up your search, click **Find**. To replace text, click **Replace** instead.

For more information on using Find & Replace, see the *Writer Guide*.

Tip If you click **Find All**, OOo selects all instances of the search text in the document. Similarly, if you click **Replace All**, OOo replaces all matches.

Caution Use **Replace All** with caution; otherwise, you may end up with some hilarious (and highly embarrassing) mistakes. A mistake with **Replace All** might require a manual, word-by-word, search to fix.



Inserting special characters

A *special character* is one not found on a standard English keyboard. For example, © ¾ æ ç ñ ö ø ¢ are all special characters. To insert a special character:

- 1) Place the cursor where you want the character to appear.
- 2) Choose **Insert > Special Character** to open the Special Characters dialog.
- 3) Select the characters (from any font or mixture of fonts) you wish to insert, in order, then click **OK**. The selected characters are shown in the lower left of the dialog. As you select a character, it is shown on the lower right, along with its numerical code.

Note Different fonts include different special characters. If you do not find a particular special character, try changing the *Font* selection.

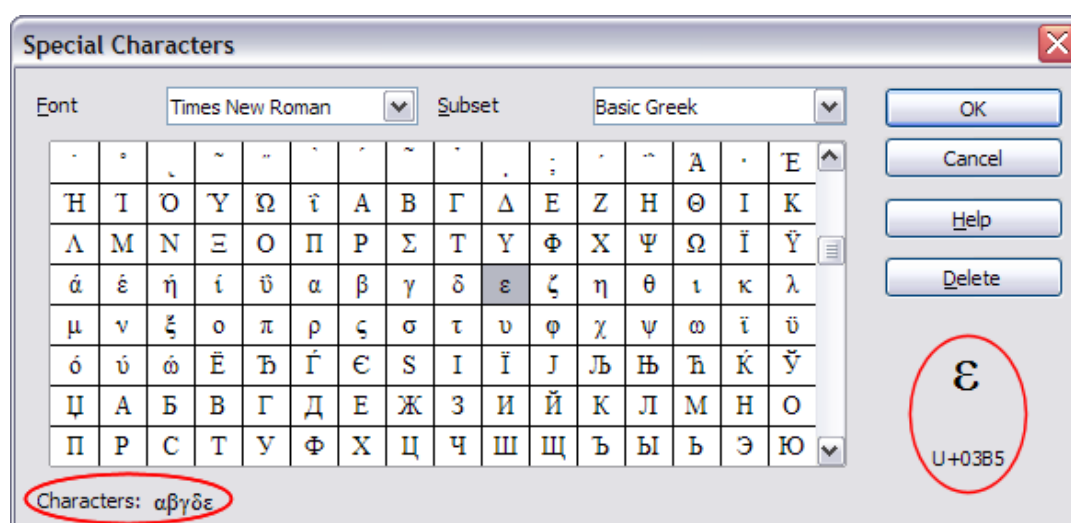

Figure 72: The Special Characters dialog, where you can insert special characters.

Inserting dashes and non-breaking spaces and hyphens

To prevent two words from being separated at the end of a line, press *Control+Shift+spacebar* after the first word to insert a non-breaking space.

In cases where you do not want the hyphen to appear at the end of a line, for example in a number such as 123-4567, you can press *Control+Shift+minus sign* to insert a non-breaking hyphen.

To enter en and em dashes, you can use the *Replace dashes* option on the Options tab under **Tools > AutoCorrect Options**. This option replaces two hyphens, under certain conditions, with the corresponding dash.

- is an en-dash; that is, a dash the width of the letter “n” in the font you are using. Type at least one character, a space, one or two hyphens, another space, and at least one more letter, then a space. The one or two hyphens will be replaced by an en-dash.
- is an em-dash; that is, a dash the width of the letter “m” in the font you are using. Type at least one character, two hyphens, and at least one more character, then a space. The two hyphens will be replaced by an em-dash.

See the Help for more details. For other methods of inserting dashes, see the *Writer Guide*.

Setting tab stops and indents

The horizontal ruler shows both the default tab stops and any tab stops that you have defined. Tab settings affect indentation of full paragraphs (using the Increase Indent and Decrease Indent icons on the Formatting toolbar) as well as indentation of parts of a paragraph (by pressing the *Tab* key on the keyboard).

Using the default tab spacing can cause formatting problems if you share documents with other people. If you use the default tab spacing and then send the document to someone else who has chosen a different default tab spacing, tabbed material will change to use the other person’s settings. This may cause major formatting problems. Instead of using the defaults, define your own tab settings, as described in this section.

To define indents and tab settings for one or more selected paragraphs, double-click on a part of the ruler that is not between the left and right indent icons to open the *Indents & Spacing* page of the Paragraph dialog. Double-click anywhere between the left and right indent icons on the ruler to open the *Tabs* page of the Paragraph dialog.

A better strategy is to define tabs for the paragraph *style*. See Chapters 6 and 7 in the *Writer Guide* for more information.

Tip

Using tabs to space out material on a page is not recommended. Depending on what you are trying to accomplish, a table is usually a better choice.

Changing the default tab stop interval

Note

Any changes to the default tab setting will affect the existing default tab stops in any document you open afterward, as well as tab stops you insert after making the change.

To set the measurement unit and the spacing of default tab stop intervals, go to **Tools > Options > OpenOffice.org Writer > General**.

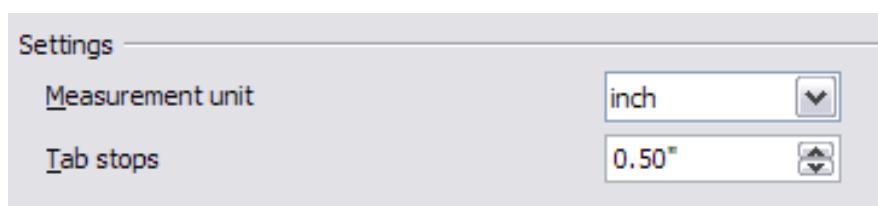

Figure 73: Selecting a default tab stop interval

You can also set or change the measurement unit for rulers in the current document by right-clicking on the ruler to open a list of units. Click on one of them to change the ruler to that unit. The selected setting applies only to that ruler.

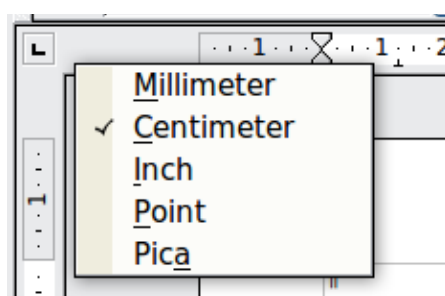



Figure 74: Changing the measurement unit for a ruler

Checking spelling and grammar

Writer provides a spelling checker, which can be used in two ways.

 **AutoSpellcheck** checks each word as it is typed and displays a wavy red line under any misspelled words. When the word is corrected, the line disappears.

 To perform a separate spelling check on the document (or a text selection) click the **Spelling and Grammar** button. This checks the document or selection and opens the Spelling and Grammar dialog if any misspelled words are found.

Here are some more features of the spelling checker:

- You can right-click on a word with a wavy underline to open a context menu. If you select from the suggested words on the menu, the selection will replace the misspelled word in your text. Other menu options are discussed below.
- You can change the dictionary language (for example, Spanish, French or German) on the Spelling and Grammar dialog.
- You can add a word to the dictionary. Click **Add** in the Spelling and Grammar dialog and pick the dictionary to add it to.
- Click the **Options** button on the Spelling and Grammar dialog to open a dialog similar to the one in **Tools > Options > Language Settings > Writing Aids** described in Chapter 2. There you can choose whether to check uppercase words and words with numbers, and you can manage custom dictionaries, that is, add or delete dictionaries and add or delete words in a dictionary.
- On the Font tab of the Paragraph Styles dialog, you can set paragraphs to be checked in a specific language (different from the rest of the document). See Chapter 7 (Working with Styles) in the *Writer Guide* for more information.

Writer does not include a grammar checker, but you can install an extension such as Language Tool and access it from **Tools > Spelling and Grammar**. (See Chapter 14 for more about installing extensions.)

Language Tool adds a new menu item and submenu to the Tools menu, from which you can configure the tool and check or recheck the document.

Using built-in language tools

Writer provides some tools that make your work easier if you mix multiple languages within the same document or if you write documents in various languages.

The main advantage of changing the language is that you can then use the correct dictionaries to check spelling and apply the localized versions of Autocorrect replacement tables, thesaurus, and hyphenation rules.

You can also set the language for a paragraph or a group of characters as **None**. This option is especially useful when you insert text such as web addresses or programming language snippets that you do not want to check for spelling.

Specifying the language in character and paragraph styles is the preferred method, because styles allow a greater level of control and make changing the language much faster. On the Font tab of the Paragraph Styles dialog, you can specify that certain paragraphs be checked in a language that is different from the language of the rest of the document. See Chapter 7 (Working with Styles) in the *Writer Guide* for information on how to manage the language settings of a style.

You can set the language for the whole document, for individual paragraphs, or even for individual words and characters, all from **Tools > Language** on the menu bar.

Another way to change the language of a whole document is to use **Tools > Options > Language Settings > Languages**. In the *Default languages for documents* section of the Options dialog, you can choose a different language for all the text.

The spelling checker works only for those languages in the list that have the symbol



next to them. If you do not see the symbol next to your preferred language, you can install the additional dictionary using **Tools > Languages > More dictionaries online**.

The language used for checking spelling is also shown in the status bar, next to the page style in use.

Using AutoCorrect

Writer's AutoCorrect function has a long list of common misspellings and typing errors, which it corrects automatically. For example, "hte" will be changed to "the".

Choose **Tools > AutoCorrect Options** to open the AutoCorrect dialog. There you can define which strings of text are corrected and how. In most cases, the defaults are fine.

AutoCorrect is turned on when Writer is installed. To turn it off, uncheck **Format > AutoCorrect > While Typing**.

To stop Writer replacing a specific spelling, go to the **Replace** tab, highlight the word pair, and click **Delete**.

To add a new spelling to the list, type it into the *Replace* and *With* boxes on the Replace tab, and click **New**.

See the different tabs of the dialog for the wide variety of other options available to fine-tune AutoCorrect.

Tip

AutoCorrect can be used as a quick way to insert special characters. For example, (c) will be autocorrected to ©. You can add your own special characters.

Using word completion

If Word Completion is enabled, Writer tries to guess which word you are typing and offers to complete the word for you. To accept the suggestion, press *Enter*. Otherwise continue typing.

To turn off Word Completion, select **Tools > AutoCorrect Options > Word Completion** and deselect **Enable word completion**.

You can customize word completion from the **Word Completion** page of the AutoCorrect dialog:

- Add (append) a space automatically after an accepted word
- Show the suggested word as a tip (hovering over the word) rather than completing the text as you type
- Change the maximum number of words remembered for word completion and the length of the smallest words to be remembered
- Delete specific entries from the word completion list
- Change the key that accepts a suggested entry—the options are *Right arrow*, *End key*, *Return (Enter)*, and *Space bar*

Note

Automatic word completion only occurs after you type a word for the second time in a document.

Using AutoText

Use AutoText to store text, tables, graphics and other items for reuse and assign them to a key combination for easy retrieval. For example, rather than typing “Senior Management” every time you use that phrase, you can set up an AutoText entry to insert those words when you type “sm” and press *F3*.

Creating AutoText

To store some text as AutoText:

- 1) Type the text into your document.
- 2) Select the text.
- 3) Choose **Edit > AutoText** (or press *Control+F3*).
- 4) In the AutoText dialog box, type a name for the AutoText in the *Name* box. Writer will suggest a one-letter shortcut, which you can change.
- 5) In the large box to the left, choose the category for the AutoText entry, for example *My AutoText*.
- 6) Click the **AutoText** button on the right and select **New (text only)** from the menu.
- 7) Click **Close** to return to your document.

Tip

If the only option under the AutoText button is Import, either you have not entered a name for your AutoText or there is no text selected in the document.

AutoText is especially powerful when assigned to fields. See Chapter 14 (Working with Fields) in the *Writer Guide* for more information.

Inserting AutoText

To insert AutoText, type the shortcut and press *F3*.

Formatting text

Using styles is recommended

Styles are central to using Writer. Styles enable you to easily format your document consistently, and to change the format with minimal effort. A style is a named set of formatting options. Writer defines several types of styles, for different types of elements: characters, paragraphs, pages, frames, and lists. See Chapter 3 (Using Styles and Templates) in this book and Chapters 6 and 7 in the *Writer Guide*.

Formatting paragraphs

You can apply many formats to paragraphs using the buttons on the Formatting toolbar. Figure 75 shows the Formatting toolbar as a floating toolbar, customized to show only the icons for paragraph formatting. The appearance of the icons may vary with your operating system and the selection of icon size and style in **Tools > Options > OpenOffice.org > View**.

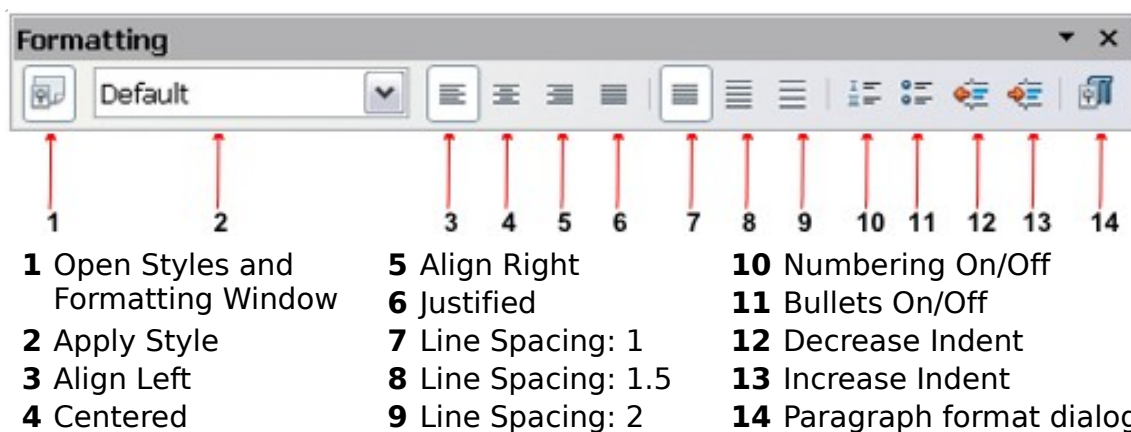
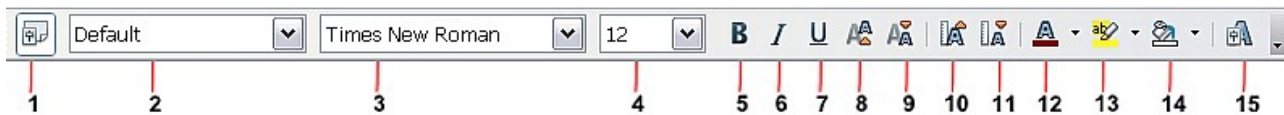

Figure 75: Formatting toolbar, showing icons for paragraph formatting

Formatting characters

You can apply many formats to characters using the buttons on the Formatting toolbar. Figure 76 shows the Formatting toolbar, customized to include only the icon for character formatting.

The appearance of the icons may vary with your operating system and the selection of icon size and style in **Tools > Options > OpenOffice.org > View**.



- | | | |
|--|-------------------------|--|
| 1 Open Styles and Formatting Window | 6 Italic | 12 Font Color |
| 2 Apply Style | 7 Underline | 13 Highlighting |
| 3 Font Name | 8 Superscript | 14 Background Color |
| 4 Font Size | 9 Subscript | 15 Open Character Format Dialog |
| 5 Bold | 10 Increase Font | |
| | 11 Reduce Font | |

Figure 76: Formatting toolbar, showing icons for character formatting

Tip

To remove manual formatting, select the text and choose **Format > Default Formatting**, or right-click and choose **Default Formatting**.

Autoformatting

You can set Writer to automatically format parts of a document according to the choices made on the Options page of the AutoCorrect dialog (**Tools > AutoCorrect Options**).

Tip

If you notice unexpected formatting changes occurring in your document, this is the first place to look for the cause.

Some common unwanted or unexpected formatting changes include:

- Horizontal lines. If you type three or more hyphens (---), underscores (___) or equal signs (===) on a line and then press *Enter*, the paragraph is replaced by a horizontal line as wide as the page. The line is actually the lower border of the preceding paragraph.
- Bulleted and numbered lists. A bulleted list is created when you type a hyphen (-), star (*), or plus sign (+), followed by a space or tab at the beginning of a paragraph. A numbered list is created when you type a number followed by a period (.), followed by a space or tab at the beginning of a paragraph. Automatic numbering is only applied to paragraphs formatted with the *Default*, *Text body* or *Text body indent* paragraph styles.

To turn autoformatting on or off, choose **Format > AutoCorrect** and select or deselect the items on the list.

Creating numbered or bulleted lists

There are several ways to create numbered or bulleted lists:

- Use autoformatting, as described above.
- Use list (numbering) styles, as described in Chapters 6 (Introduction to Styles) and 7 (Working with Styles) in the *Writer Guide*.
- Use the Numbering and Bullets icons on the paragraph formatting toolbar (see Figure 75): select the paragraphs in the list, and then click the appropriate icon on the toolbar.

Note

It is a matter of personal preference whether you type your information first, then apply Numbering/Bullets, or apply them as you type.

Using the Bullets and Numbering toolbar

You can create nested lists (where one or more list items has a sub-list under it, as in an outline) by using the buttons on the Bullets and Numbering toolbar (Figure 77). You can move items up or down the list, or create sub-points, and even change the style of bullets. Use **View > Toolbars > Bullets and Numbering** to see the toolbar.

The appearance of the icons may vary with your operating system and the selection of icon size and style in **Tools > Options > OpenOffice.org > View**.

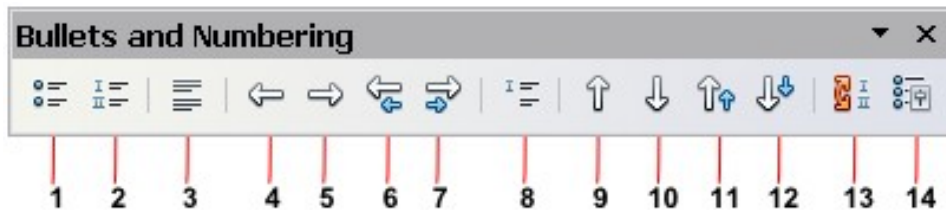

- | | | |
|----------------------------|---|------------------------------------|
| 1 Bullets On/Off | 6 Promote One Level with Subpoints | 10 Move Down |
| 2 Numbering On/Off | | 11 Move Up with Subpoints |
| 3 Numbering Off | 7 Demote One Level with Subpoints | 12 Move Down with Subpoints |
| 4 Promote One Level | 8 Insert Unnumbered Entry | 13 Restart Numbering |
| 5 Demote One Level | 9 Move Up | 14 Bullets and Numbering |

Figure 77: Bullets and Numbering toolbar

Hyphenating words

You have several choices regarding hyphenation: let Writer do it automatically (using its hyphenation dictionaries), insert conditional hyphens manually where necessary, or don't hyphenate at all.

Automatic hyphenation

To turn automatic hyphenation of words on or off:

- 1) Press *F11* ($\text{⌘}+T$ on Mac) to open the Styles and Formatting window.
- 2) On the Paragraph Styles page of the Styles and Formatting window (Figure 78), right-click on **Default** and select **Modify**.
- 3) On the Paragraph Style dialog (Figure 79), go to the **Text Flow** page.
- 4) Under Hyphenation, select or deselect the **Automatically** option. Click **OK** to save.

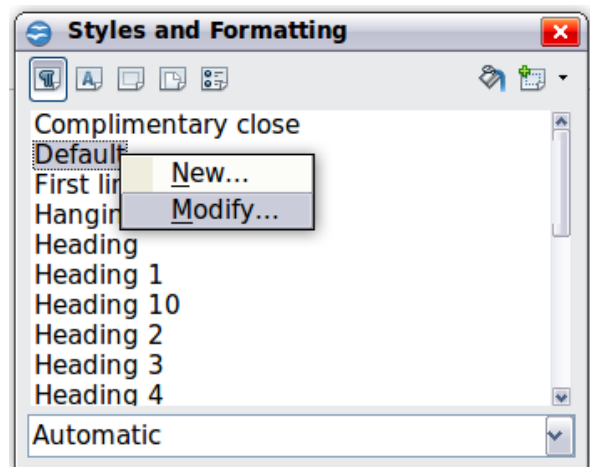

Figure 78: Modifying a style

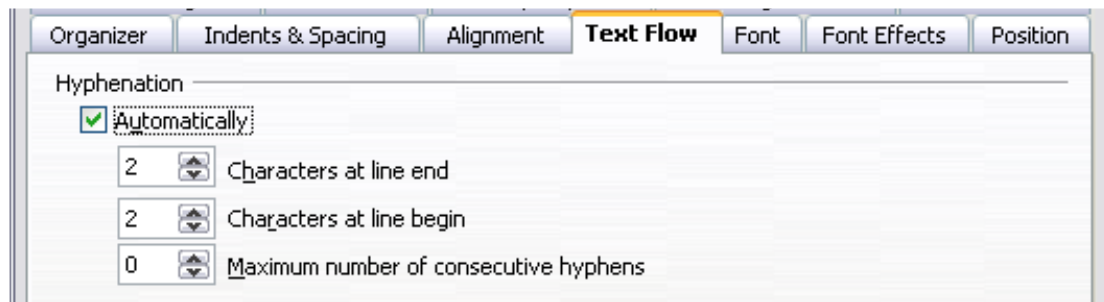

Figure 79: Turning on automatic hyphenation

Note

Turning on hyphenation for the Default paragraph style affects all other paragraph styles that are based on Default. You can individually change other styles so that hyphenation is not active; for example, you might not want headings to be hyphenated. Any styles that are not based on Default are not affected. See Chapter 3 (Styles and Templates) for more about styles based on other styles)

You can also set hyphenation choices through **Tools > Options > Language Settings > Writing Aids**. In Options, near the bottom of the dialog, scroll down to find the hyphenation settings.

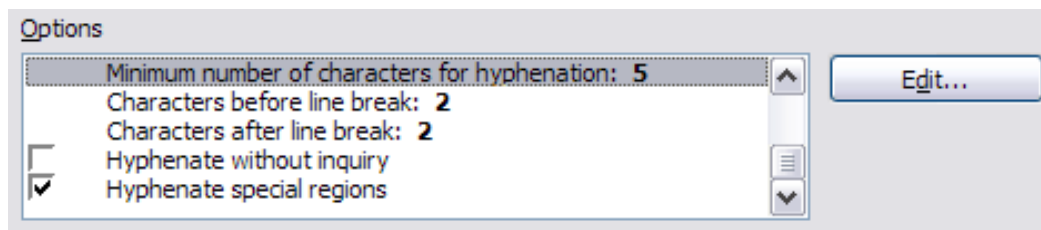

Figure 80: Setting hyphenation options

To change the minimum number of characters for hyphenation, the minimum number of characters before a line break, or the minimum number of characters after a line break, select the item, and then click the **Edit** button in the Options section.

Hyphenation options set on the Writing Aids dialog are effective only if hyphenation is turned on through paragraph styles.

Manual hyphenation

To manually hyphenate words, *do not* use a normal hyphen, which will remain visible even if the word is no longer at the end of a line when you add or delete text or change margins or font size. Instead, use a *conditional hyphen*, which is visible only when required.

To insert a conditional hyphen inside a word, click where you want the hyphen to appear and press **Control+hyphen**. The word will be hyphenated at this position when it is at the end of the line, even if automatic hyphenation for this paragraph is switched off.

Formatting pages

Writer provides several ways for you to control page layouts: page styles, columns, frames, tables, and sections. For more information, see Chapter 4 (Formatting Pages) in the *Writer Guide*.

Tip

Page layout is usually easier if you show text, object, table, and section boundaries in **Tools > Options > OpenOffice.org > Appearance**, and paragraph ends, tabs, breaks, and other items in **Tools > Options > OpenOffice.org Writer > Formatting Aids**.

Which layout method to choose?

The best layout method varies depending on what the final document should look like and what sort of information will be in the document. Here are some examples.

For a book similar to this user guide, with one column of text, some figures without text beside them, and some other figures with descriptive text, use page styles for basic layout, and tables to place figures beside descriptive text when necessary.

Items formatted as a table

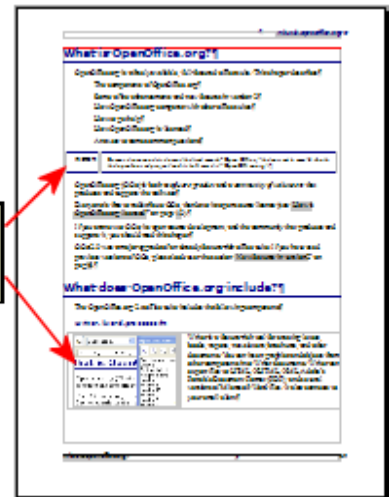

For an index or other document with two columns of text, where the text continues from the left-hand column to the right-hand column and then to the next page, all in sequence (also known as “snaking columns” of text), use page styles (with two columns). If the title of the document (on the first page) is full-page width, put it in a single-column section.

Title is in a single column section

Basic layout is in two columns

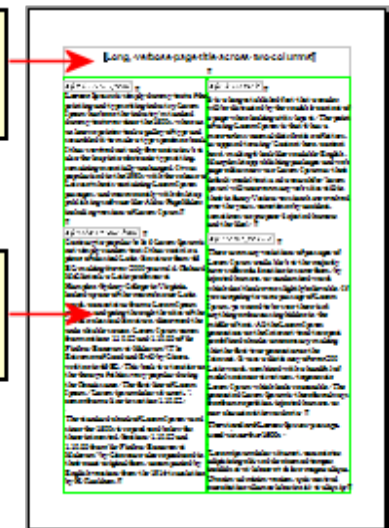

For a newsletter with complex layout, two or three columns on the page, and some articles that continue from one page to some place several pages later, use page styles for basic layout. Place articles in linked frames and anchor graphics to fixed positions on the page if necessary.

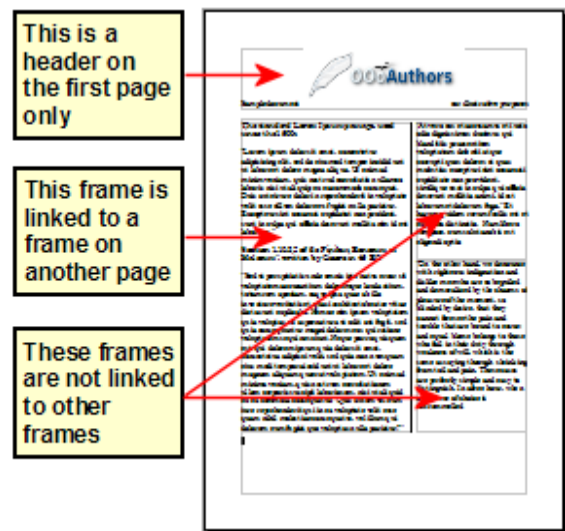

For a document with terms and translations to appear side-by-side in what appear to be columns, use a table to keep items lined up, and so you can type in both “columns”.

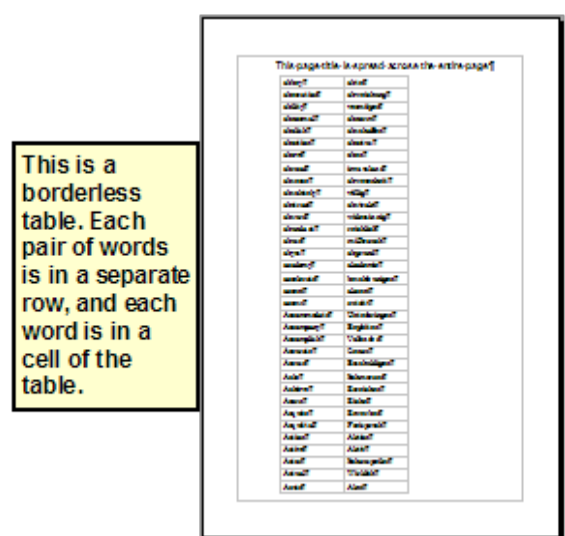

Creating headers and footers

A header is an area that appears at the top of a page. A footer appears at the bottom of the page. Information such as page numbers inserted into a header or footer displays on every page of the document with that page style.

To insert a header, choose **Insert > Header > Default** (or the page style, if not Default).

Other information such as document titles and chapter titles is often put into the header or footer. These items are best added as fields. That way, if something changes, the headers and footers are updated automatically. Here is one common example.

To insert the document title into the header:

- 1) Choose **File > Properties > Description** and type a title for your document.
- 2) Add a header (**Insert > Header > Default**).
- 3) Place the cursor in the header part of the page.
- 4) Choose **Insert > Fields > Title**. The title should appear on a gray background (which does not show when printed and can be turned off).

- 5) To change the title for the whole document, go back to **File > Properties > Description**.

Fields are covered in detail in Chapter 14 (Working with Fields) in the *Writer Guide*.

For more about headers and footers, see Chapter 4 (Formatting Pages) and Chapter 6 (Introduction to Styles) in the *Writer Guide*.

Numbering pages

To automatically number pages:

- 1) Insert a header or footer, as described in “Creating headers and footers” on page 95.
- 2) Place the cursor in the header or footer where you want the page number to appear and choose **Insert > Fields > Page Number**.

Including the total number of pages

To include the total number of pages (as in “page 1 of 12”):

- 1) Type the word “page” and a space, then insert the page number as above.
- 2) Press the spacebar once, type the word “of” and a space, then choose **Insert > Fields > Page Count**.

Note

The Page Count field inserts the total number of pages in the document, as shown on the Statistics tab of the document’s Properties window (**File > Properties**). If you restart page numbering anywhere in the document, then the total page count may not be what you want. See Chapter 4 (Formatting Pages) in the *Writer Guide* for more information.

Restarting page numbering

Often you will want to restart the page numbering at 1, for example on the page following a title page or a table of contents. In addition, many documents have the “front matter” (such as the table of contents) numbered with Roman numerals and the main body of the document numbered in Arabic numerals, starting with 1.

You can restart page numbering in two ways.

Method 1:

- 1) Place the cursor in the first paragraph of the new page.
- 2) Choose **Format > Paragraph**.
- 3) On the Text Flow tab of the Paragraph dialog (Figure 81), select **Breaks**.
- 4) Select **Insert** and then **With Page Style** and specify the page style to use.
- 5) Specify the page number to start from, and then click **OK**.

Tip

Method 1 is also useful for numbering the first page of a document with a page number greater than 1. For example, you may be writing a book, with each chapter in a separate file. Chapter 1 may start with page 1, but Chapter 2 could begin with page 25 and Chapter 3 with page 51.

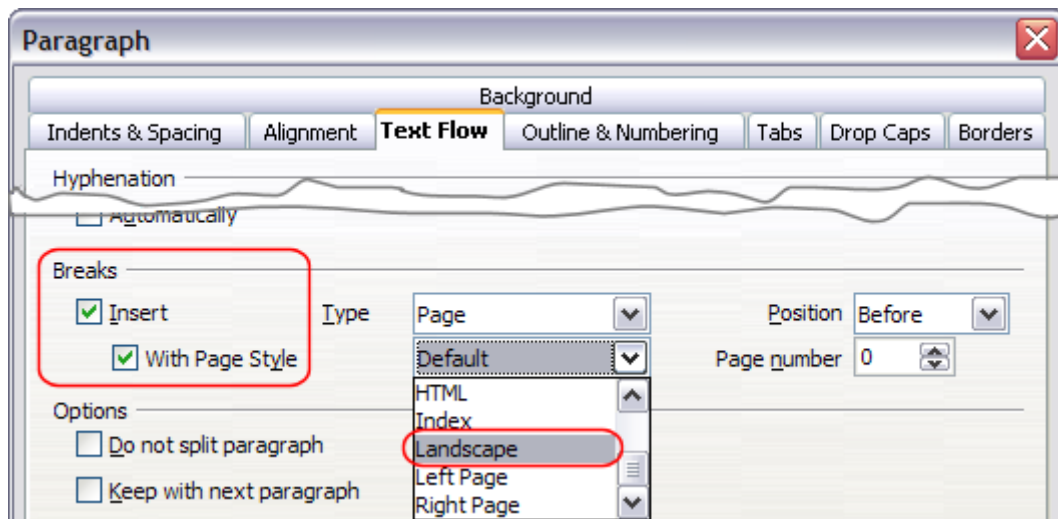

Figure 81: Specifying a page break before a paragraph

Method 2:

- 1) **Insert > Manual break.**
- 2) By default, **Page break** is selected on the Insert Break dialog (Figure 82).
- 3) Choose the required page **Style**.
- 4) Select **Change page number**.
- 5) Specify the page number to start from, and then click **OK**.

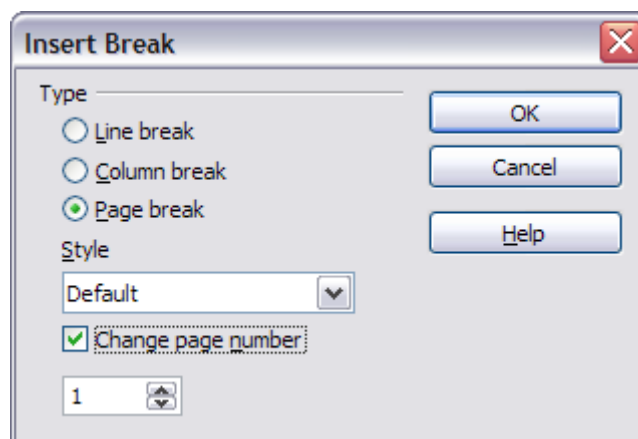

Figure 82: Restarting page numbering after a manual page break

Changing page margins

You can change page margins in two ways:

- Using the page rulers—quick and easy, but does not have fine control
- Using the Page Style dialog—can specify margins to two decimal places

Note

If you change the margins using the rulers, the new margins affect the page style and will be shown in the Page Style dialog the next time you open it.

Because the page style is affected, the changed margins apply to **all** pages using that style.

To change margins using the rulers:

- 1) The gray sections of the rulers are the margins. Put the mouse cursor over the line between the gray and white sections. The pointer turns into a double-headed arrow.
- 2) Hold down the left mouse button and drag the mouse to move the margin.

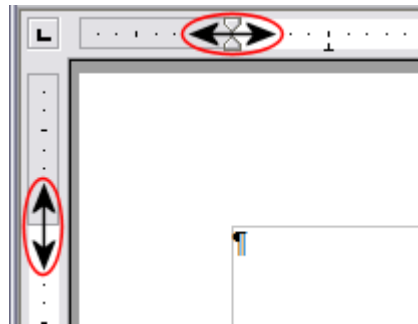

Figure 83: Moving the margins

Tip

The small arrows on the ruler are used for indenting paragraphs. They are often in the same place as the page margins, so you need to be careful to move the margin marker, not the arrows. Place the mouse pointer between the arrows and, when the pointer turns into a double-headed arrow, you can move the margin (the indent arrows will move with it).

To change margins using the Page Style dialog:

- 1) Right-click anywhere on the page and select **Page** from the pop-up menu.
- 2) On the **Page** tab of the dialog, type the required distances in the Margins boxes.

Adding comments to a document

Authors and reviewers often use comments (formerly called “notes”) to exchange ideas, ask for suggestions, or mark items needing attention.

To insert a comment in the text, place the cursor in the place the comment refers to and choose **Insert > Comment** or press *Ctrl+Alt+N*. The anchor point of the comment is connected by a dotted line to a box on the right-hand side of the page where you can type the text of the comment. Writer automatically adds at the bottom of the comment the author’s name and a time stamp indicating when the comment was created. Figure 84 shows an example of text with comments from two different authors.

Choose **Tools > Options > User Data** to configure the name you want to appear in the Author field of the comment, or to change it.

If more than one person edits the document, each author is automatically allocated a different background color.

Right-clicking on a comment pops up a menu where you can delete the current comment, all the comments from the same author, or all the comments in the document. From this menu, you can also apply some basic formatting to the text of the comment. You can also change the font type, size, and alignment from the main menu.

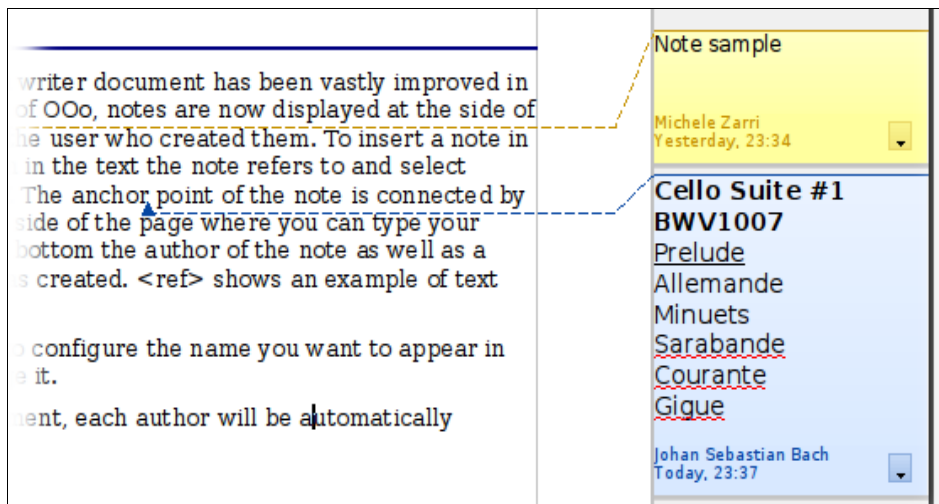

Figure 84: Example of comments

To navigate from one comment to another, open the Navigator (*F5*), expand the Comments section, and click on the comment text to move the cursor to the anchor point of the comment in the document. Right-click on the comment to quickly edit or delete it.

You can also navigate through the comments using the keyboard. Use *Ctrl+Alt+Page Down* to move to the next comment and *Ctrl+Alt+Page Up* to move to the previous comment.

Creating a table of contents

Writer's table of contents feature lets you build an automated table of contents from the headings in your document. Before you start, make sure that the headings are styled consistently. For example, you can use the *Heading 1* style for chapter titles and the *Heading 2* and *Heading 3* styles for chapter subheadings.

Although tables of contents can be customized extensively in Writer, often the default settings are all you need. Creating a quick table of contents is simple:

- 1) When you create your document, use the following paragraph styles for different heading levels (such as chapter and section headings): *Heading 1*, *Heading 2*, *Heading 3*, and so on. These are what will appear in your table of contents.
- 2) Place the cursor where you want the table of contents to be inserted.
- 3) Choose **Insert > Indexes and Tables > Indexes and Tables**.
- 4) Change nothing in the Insert Index/Table dialog. Click **OK**.

If you add or delete text (so that headings move to different pages) or you add, delete, or change headings, you need to update the table of contents.

To do this:

- 1) Place the cursor within the table of contents.
- 2) Right-click and choose **Update Index/Table** from the pop-up menu.

Note

If you cannot place your cursor in the table of contents, choose **Tools > Options > OpenOffice.org Writer > Formatting Aids**, and then select **Enable** in the **Cursor in protected areas** section.

You can customize an existing table of contents at any time. Right-click anywhere in it and choose **Edit Index/Table** from the pop-up menu. Chapter 12 (Creating Tables of Contents, Indexes and Bibliographies) of the *Writer Guide* describes in detail all the customizations you can choose.

Creating indexes and bibliographies

Indexes and bibliographies work in a similar way to tables of contents. Chapter 12 (Creating Tables of Contents, Indexes and Bibliographies) in the *Writer Guide* describes the process in detail.

In addition to alphabetical indexes, other types of indexes supplied with Writer include those for illustrations, tables, and objects, and you can even create a user-defined index. For example, you might want an index containing only the scientific names of species mentioned in the text, and a separate index containing only the common names of species. Before creating some types of indexes, you first need to create index entries embedded in your Writer document.

Working with graphics

Graphics in Writer are of three basic types:

- Image files, including photos, drawings, scanned images, and others
- Diagrams created using OOO's drawing tools
- Charts created using OOO's Chart facility

See Chapter 11 (Graphics, the Gallery, and Fontwork) in this book and Chapter 8 (Working with Graphics) in the *Writer Guide*.

Printing

See Chapter 10 (Printing, Exporting, and E-mailing) in this book and Chapter 5 (Printing, Exporting, Faxing, and E-mailing) in the *Writer Guide* for details on previewing pages before printing, selecting print options, printing in black and white on a color printer, printing brochures, and other printing features.

Using mail merge

Writer provides very useful features to create and print:

- Multiple copies of a document to send to a list of different recipients (form letters)
- Mailing labels
- Envelopes

All these facilities use a registered data source (a spreadsheet or database containing the name and address records and other information).

Chapter 11 (Using Mail Merge) in the *Writer Guide* describes the process.

Tracking changes to a document

You can use several methods to keep track of changes made to a document.

- 1) Make your changes to a copy of the document (stored in a different folder, or under a different name, or both), then use Writer to combine the two files and show the differences. Choose **Edit > Compare Document**. This technique is particularly useful if you are the only person working on the document, as it avoids the increase in file size and complexity caused by the other methods.
- 2) Save versions that are stored as part of the original file. However, this method can cause problems with documents of non-trivial size or complexity, especially if you save a lot of versions. Avoid this method if you can.
- 3) Use Writer's change marks (often called "redlines" or "revision marks") to show where you have added or deleted material, or changed formatting. Choose **Edit > Changes > Record**. Later, you or another person can review and accept or reject each change. Right-click on an individual change and choose **Accept Change** or **Reject Change** from the pop-up menu, or choose **Edit > Changes > Accept or Reject** to view the list of changes and accept or reject them. Details are in the *Writer Guide*.

Tip

Not all changes are recorded. For example, changing a tab stop from align left to align right, and changes in formulas (equations) or linked graphics are not recorded.

Using fields

Fields are extremely useful features of Writer. They are used for data that changes in a document (such as the current date or the total number of pages) and for inserting document properties such as name, author, and date of last update. Fields are the basis of cross-referencing (see below); automatic numbering of figures, tables, headings, and other elements; and a wide range of other functions—far too many to describe here. See Chapter 14 (Working with Fields) in the *Writer Guide* for details.

Linking to another part of a document

If you type in cross-references to other parts of a document, those references can easily get out of date if you reorganize the order of topics, add or remove material, or reword a heading. Writer provides two ways to ensure that your references are up to date, by inserting links to other parts of the same document or to a different document:

- Hyperlinks
- Cross-references

The two methods have the same result if you *Control+click* the link when the document is open in Writer: you are taken directly to the cross-referenced item. However, they also have major differences:

- The text in a hyperlink does **not** automatically update if you change the text of the linked item (although you can change it manually), but changed text does automatically update in a cross-reference.

- When using a hyperlink, you do not have a choice of the content of the link (for example text or page number), but when using a cross-reference, you have several choices, including bookmarks.
- To hyperlink to an object such as a graphic, and have the hyperlink show useful text such as *Figure 6*, you need to either give such an object a useful name instead of leaving it as the default name (“Graphics6”), or you need to use the Hyperlink dialog to modify the visible text. In contrast, cross-references to figures with captions automatically show useful text, and you have a choice of several variations of the name.
- If you save a Writer document to HTML, hyperlinks remain active but cross-references do not. (Both remain active when the document is exported to PDF.)

Using hyperlinks

The easiest way to insert a hyperlink to another part of the same document is by using the Navigator:

- 1) Open the document containing the items you want to cross-reference.
- 2) Open the Navigator by clicking its icon, choosing **View > Navigator**, or pressing *F5*.
- 3) Click the arrow next to the **Drag Mode** icon, and choose **Insert as Hyperlink**.
- 4) In the list at the bottom of the Navigator, select the document containing the item that you want to cross-reference.
- 5) In the Navigator list, select the item that you want to insert as a hyperlink.
- 6) Drag the item to where you want to insert the hyperlink in the document. The name of the item is inserted in the document as an active hyperlink.

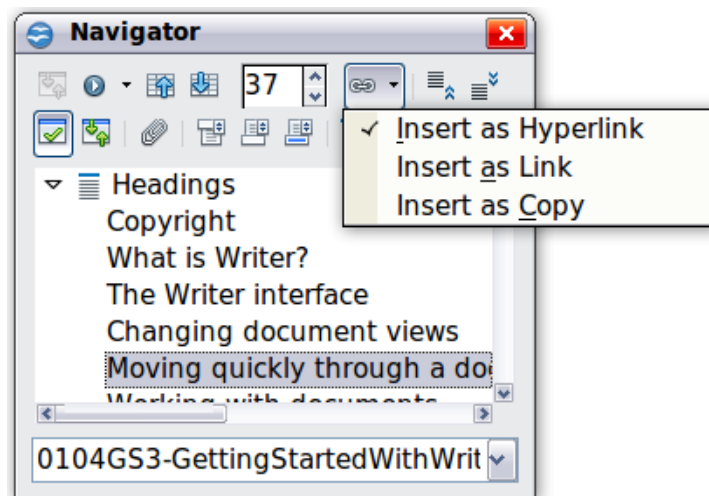

Figure 85: Inserting a hyperlink using the Navigator

You can also use the Hyperlink dialog to insert and modify hyperlinks within and between documents. See Chapter 12 (Creating Web Pages).

Using cross-references

If you type in references to other parts of the document, those references can easily get out of date if you reword a heading, add or remove figures, or reorganize topics. Replace any typed cross-references with automatic ones and, when you update fields, all the references will update automatically to show the current wording or page

numbers. The *Cross-references* tab of the Fields dialog lists some items, such as headings, bookmarks, figures, tables, and numbered items such as steps in a procedure. You can also create your own reference items; see “Setting References” in Chapter 14 (Working with Fields) in the *Writer Guide* for instructions.

To insert a cross-reference to a heading, figure, bookmark, or other item:

- 1) In your document, place the cursor where you want the cross-reference to appear.
- 2) If the Fields dialog is not open, click **Insert > Cross-reference**. On the *Cross-references* tab, in the *Type* list, select the type of item to be referenced (for example, *Heading* or *Figure*). You can leave this page open while you insert many cross-references.

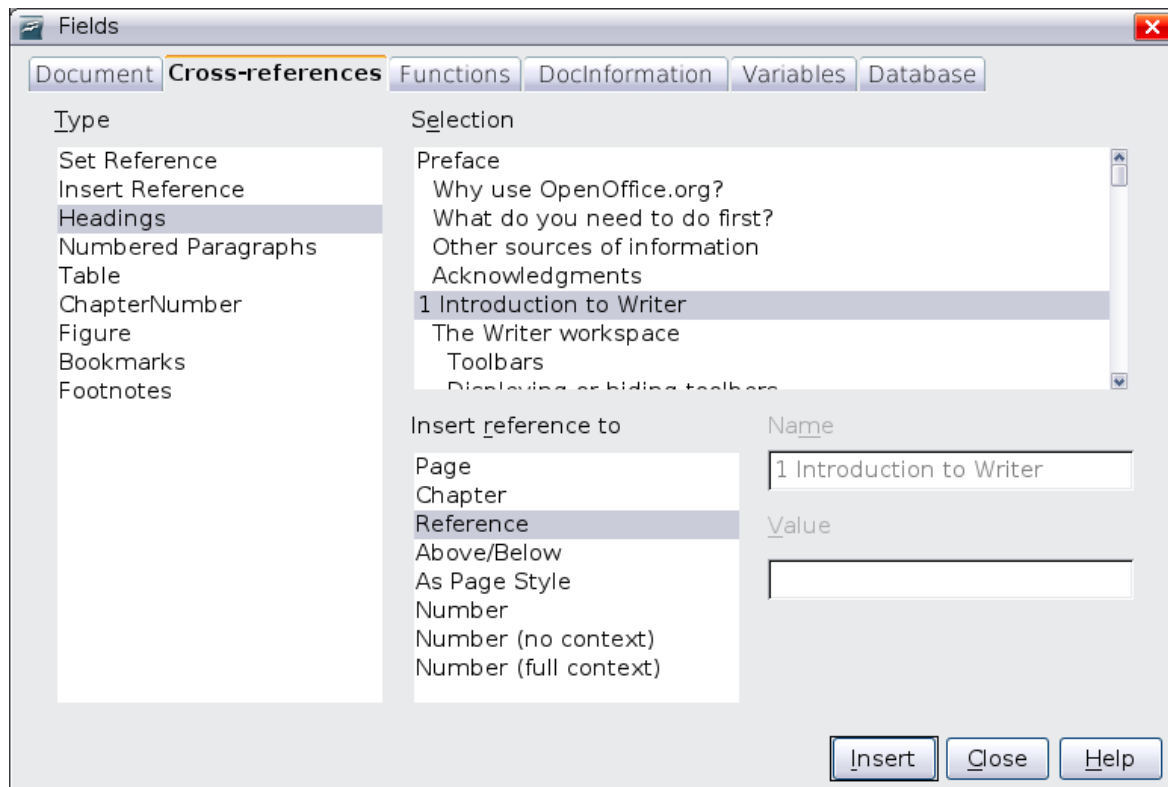

Figure 86: The Cross-references tab of the Fields dialog

- 3) Click on the required item in the *Selection* list, which shows all the items of the selected type. In the *Format* list, choose the format required. Usually this will be **Reference** (to insert the full text of the heading or caption), **Category and Number** (to insert the word “Figure” or “Table” and its number, but without the caption text), **Numbering** (to insert only the figure or table number, without the word “Figure” or “Table”), or **Page** (to insert the number of the page the referenced text is on). Click **Insert**.

Using bookmarks

Bookmarks are listed in the Navigator and can be accessed directly from there with a single mouse click. You can cross-reference to bookmarks and create hyperlinks to bookmarks, as described above.

- 1) Select the text you want to bookmark. Click **Insert > Bookmark**.
- 2) On the Insert Bookmark dialog, the larger box lists any previously defined bookmarks. Type a name for this bookmark in the top box, and then click **OK**.

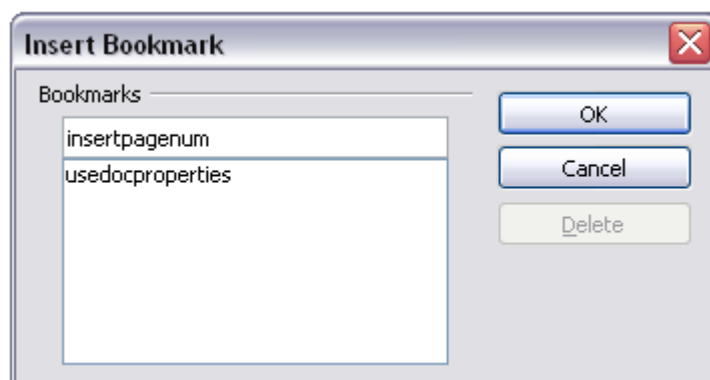

Figure 87: Inserting a bookmark

Using master documents

Master documents are typically used for producing long documents such as a book, a thesis, or a long report; or when different people are writing different chapters or other parts of the full document, so you don't need to share files. A master document joins separate text documents into one larger document, and unifies the formatting, table of contents (TOC), bibliography, index, and other tables or lists.

Yes, master documents do work in Writer. However, until you become familiar with them, you may think that master documents are unreliable or difficult to use. See Chapter 13 (Working with Master Documents) in the *Writer Guide*.

Creating fill-in forms

A standard text document displays information: a letter, report, or brochure, for example. Typically the reader may edit everything or nothing in any way. A form has sections that are not to be edited, and other sections that are designed for the reader to make changes. For example, a questionnaire has an introduction and questions (which do not change) and spaces for the reader to enter answers.

Forms are used in three ways:

- To create a simple document for the recipient to complete, such as a questionnaire sent out to a group of people who fill it in and return it.
- To link into a database or data source and allow the user to enter information. Someone taking orders might enter the information for each order into a database using a form.
- To view information held in a database or data source. A librarian might call up information about books.

Writer offers several ways to fill information into a form, including check boxes, option buttons, text boxes, pull-down lists and spinners. See Chapter 15 (Using Forms in Writer) in the *Writer Guide*.

Chapter 5

Getting Started with Calc

Using Spreadsheets in OpenOffice.org

What is Calc?

Calc is the spreadsheet component of OpenOffice.org (OOo). You can enter data (usually numerical) in a spreadsheet and then manipulate this data to produce certain results.

Alternatively you can enter data and then use Calc in a ‘What if...’ manner by changing some of the data and observing the results without having to retype the entire spreadsheet.

Other features provided by Calc include:

- Functions, which can be used to create formulas to perform complex calculations on data
- Database functions, to arrange, store, and filter data
- Dynamic charts; a wide range of 2D and 3D charts
- Macros, for recording and executing repetitive tasks
- Ability to open, edit, and save Microsoft Excel spreadsheets
- Import and export of spreadsheets in multiple formats, including HTML, CSV, PDF, and PostScript

Note

If you want to use macros written in Microsoft Excel using the VBA macro code in OOo, you must first edit the code in the OOo Basic IDE editor. See Chapter 13 (Getting Started with Macros) in this book and Chapter 12 in the *Calc Guide*.

Spreadsheets, sheets and cells

Calc works with documents called *spreadsheets*. Spreadsheets consist of a number of individual *sheets*, each sheet containing cells arranged in rows and columns. A particular cell is identified by its row number and column letter.

Cells hold the individual elements—text, numbers, formulas, and so on—that make up the data to display and manipulate.

Each spreadsheet can have many sheets, and each sheet can have many individual cells. In Calc 3.3, each sheet can have a maximum of 1,048,576 rows (65,536 rows in Calc 3.2 and earlier) and a maximum of 1024 columns.

Parts of the main Calc window

When Calc is started, the main window looks similar to Figure 88.

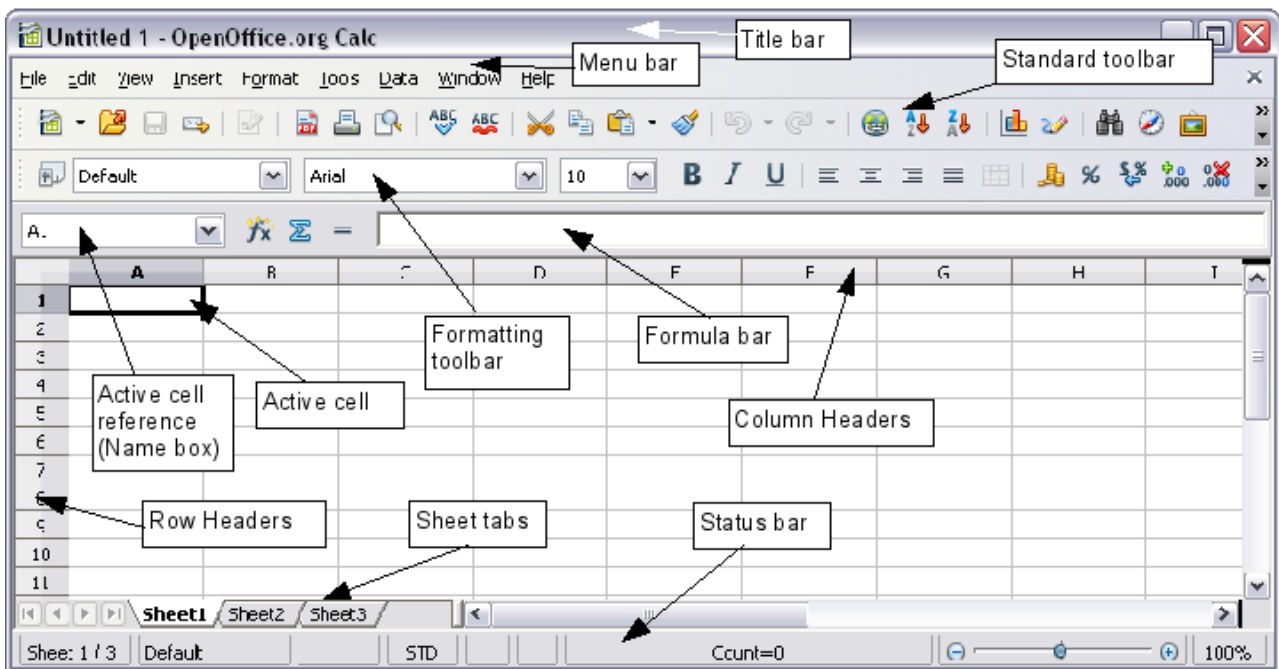

Figure 88: Parts of the Calc window

Title bar

The Title bar, located at the top, shows the name of the current spreadsheet. When the spreadsheet is newly created, its name is *Untitled X*, where *X* is a number. When you save a spreadsheet for the first time, you are prompted to enter a name of your choice.

Menu bar

Under the Title bar is the Menu bar. When you choose one of the menus, a submenu appears with other options. You can modify the Menu bar, as discussed in Chapter 14 (Customizing OpenOffice.org).

Toolbars

Three toolbars are located under the Menu bar by default: the Standard toolbar, the Formatting toolbar, and the Formula Bar.

The icons (buttons) on these toolbars provide a wide range of common commands and functions. You can also modify these toolbars, as discussed in Chapter 14 (Customizing OpenOffice.org).

In the Formatting toolbar, the three boxes on the left are the **Apply Style**, **Font Name**, and **Font Size** lists. They show the current setting for the selected cell or area. (The Apply Style list may not be visible by default.) Click the down-arrow to the right of each box to open the list.

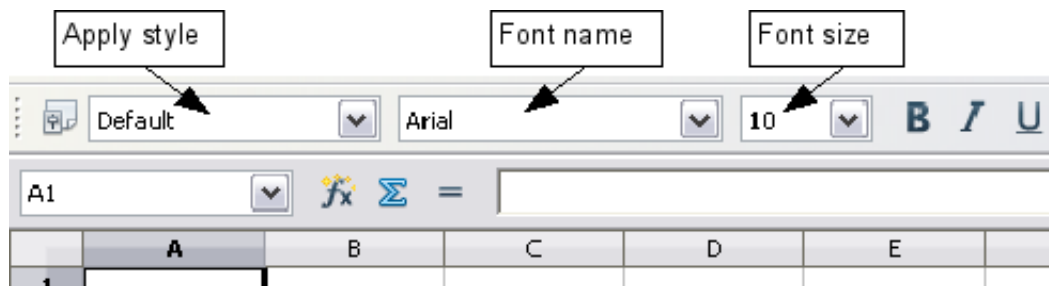

Figure 89. Apply Style, Font Name and Font Size lists

Formula bar

On the left hand side of the Formula bar is a small text box, called the **Name Box**, with a letter and number combination in it, such as **D7**. This combination, called the cell reference, is the column letter and row number of the selected cell.

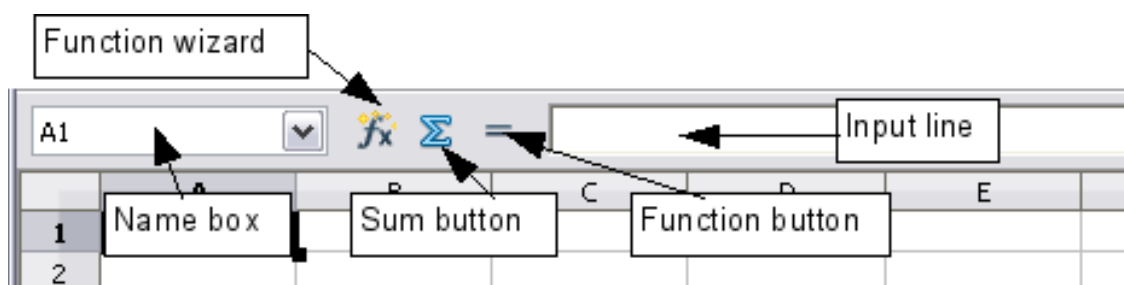

Figure 90. Formula Bar

To the right of the Name box are the the **Function Wizard**, **Sum**, and **Function** buttons.

Clicking the **Function Wizard** button opens a dialog from which you can search through a list of available functions. This can be very useful because it also shows how the functions are formatted.

In a spreadsheet the term *function* covers much more than just mathematical functions. See Chapter 7 in the *Calc Guide* for more details.

Clicking the **Sum** button inserts a formula into the current cell that totals the numbers in the cells above the current cell. If there are no numbers above the current cell, then the cells to the left are placed in the Sum formula.

Clicking the **Function** button inserts an equals (=) sign into the selected cell and the Input line, thereby enabling the cell to accept a formula.

When you enter new data into a cell, the Sum and Equals buttons change to **Cancel** and **Accept** buttons  .

The contents of the current cell (data, formula, or function) are displayed in the **Input line**, which forms the remainder of the Formula Bar. You can edit the contents of the current cell on the Input line or in the cell itself. To edit on the Input line, click in the line, then type your changes. To edit within the current cell, just double-click the cell.

Individual cells

The main section of the screen displays the cells in the form of a grid, with each cell being at the intersection of a column and a row.

At the top of the columns and at the left end of the rows are a series of gray boxes containing letters and numbers. These are the column and row headers. The columns start at A and go on to the right, and the rows start at 1 and go down.

These column and row headers form the cell references that appear in the Name Box on the Formula Bar (Figure 90). You can turn these headers off by selecting **View > Column & Row Headers**.

Sheet tabs

At the bottom of the grid of cells are the sheet tabs. These tabs enable access to each individual sheet, with the visible (active) sheet having a white tab. From Calc 3.3, you can choose colors for the different sheet tabs.

Clicking on another sheet tab displays that sheet, and its tab turns white. You can also select multiple sheet tabs at once by holding down the *Control* key while you click the names.

Status bar

At the very bottom of the Calc window is the status bar, which provides information about the spreadsheet and convenient ways to quickly change some of its features. Most of the fields are similar to those in other components of Oo; see Chapter 1 (Introducing OpenOffice.org) in this book and Chapter 1 (Introducing Calc) in the *Calc Guide*.

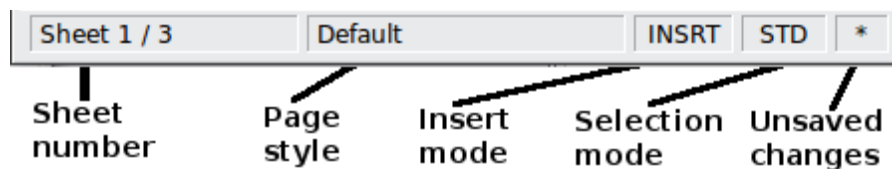

Figure 91: Left end of Calc status bar



Figure 92: Right end of Calc status bar

Opening and saving CSV files

Chapter 1 (Introducing OpenOffice.org) includes instructions on starting new Calc documents, opening existing documents, and saving documents.

A special case for Calc is opening and saving comma-separated-values (CSV), which are text files that contain the cell contents of a single sheet. Each line in a CSV file represents a row in a spreadsheet. Commas, semicolons, or other characters are used

to separate the cells. Text is entered in quotation marks, numbers are entered without quotation marks.

Opening a CSV file

To open a CSV file in Calc:

- 1) Choose **File > Open**.
- 2) Locate the CSV file that you want to open.
- 3) If the file has a *.csv extension, select the file and click **Open**.
- 4) If the file has another extension (for example, *.txt), select the file, select **Text CSV (*.csv;*.txt;*.xls)** in the File type box (scroll down into the spreadsheet section to find it) and then click **Open**.
- 5) On the Text Import dialog (Figure 93), select the Separator options to divide the text in the file into columns.

You can preview the layout of the imported data at the bottom of the dialog. Right-click a column in the preview to set the format or to hide the column.

If the CSV file uses a text delimiter character that is not in the Text delimiter list, click in the box, and type the character.

- 6) Click **OK** to open the file.

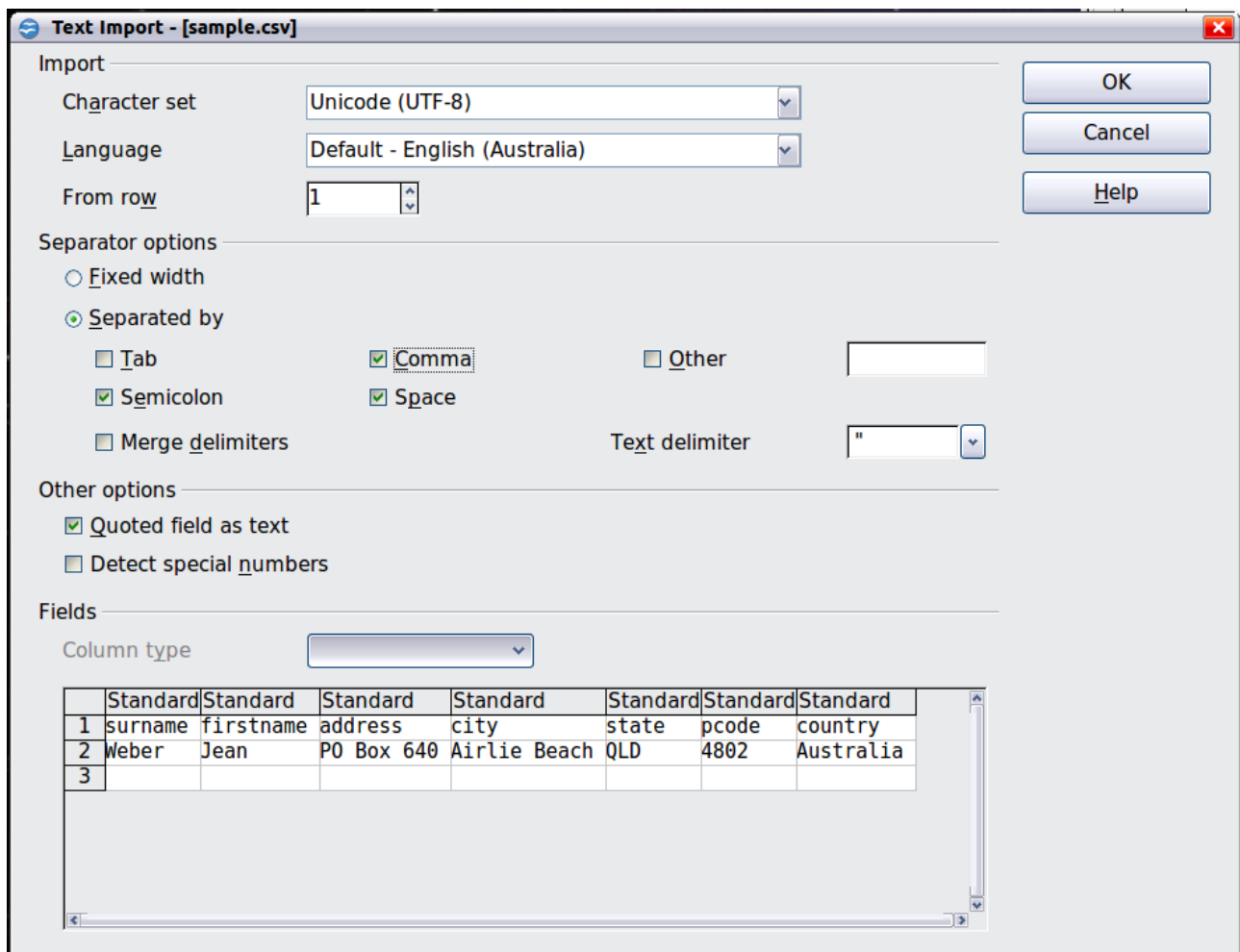

Figure 93: Text Import dialog, with Comma (,) selected as the separator and double quotation mark (") as the text delimiter.

Saving as a CSV file

To save a spreadsheet as a comma separate value (CSV) file:

- 1) Choose **File > Save As**.
- 2) In the *File name* box, type a name for the file.
- 3) In the *File type* list, select **Text CSV (.csv)** and click **Save**.

You may see the message box shown below. Click **Keep Current Format**.

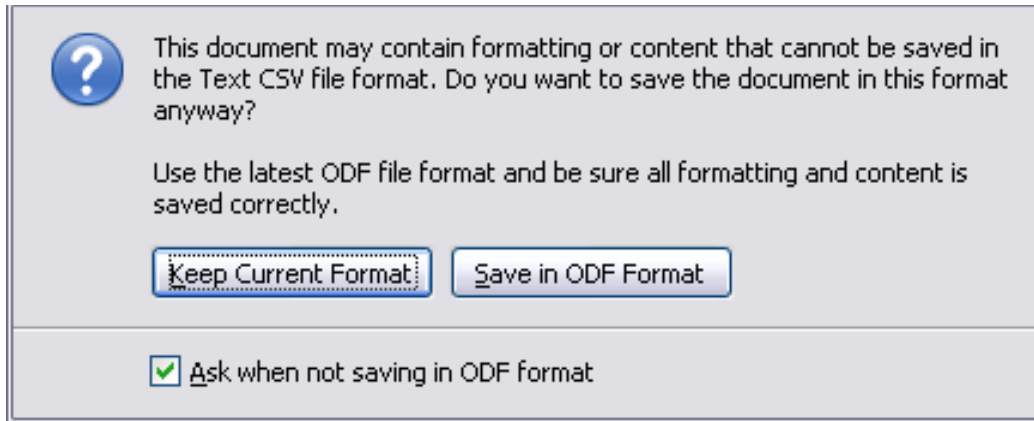

- 4) In the **Export of text files** dialog, select the options you want and then click **OK**.

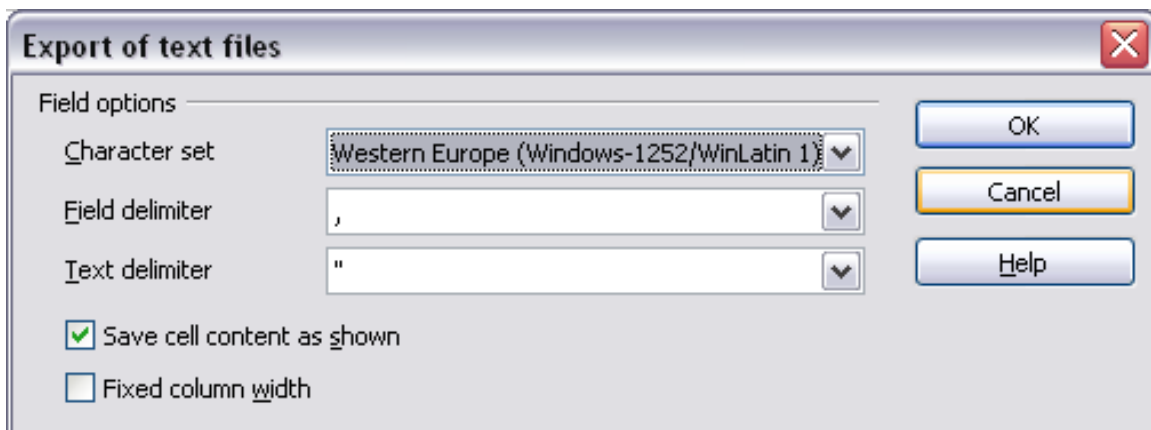

Figure 94: Choosing options when exporting to Text CSV

Navigating within spreadsheets

Calc provides many ways to navigate within a spreadsheet from cell to cell and sheet to sheet. You can generally use whatever method you prefer.

Going to a particular cell

Using the mouse

Place the mouse pointer over the cell and click.

Using a cell reference

Click on the little inverted black triangle just to the right of the Name Box (Figure 90). The existing cell reference will be highlighted. Type the cell reference of the

cell you want to go to and press *Enter*. Or just click into the Name box, backspace over the existing cell reference and type in the cell reference you want and press *Enter*.

Using the Navigator

To open the Navigator, click its icon  on the Standard toolbar, or press *F5*, or choose **View > Navigator** on the Menu bar, or double-click on the Sheet Sequence Number **Sheet1 / 3** in the Status Bar. Type the cell reference into the top two fields, labeled Column and Row, and press *Enter*. In Figure 95 the Navigator would select cell A7.

You can dock the Navigator to either side of the main Calc window or leave it floating. (To dock or float the Navigator, hold down the *Control* key and double-click in an empty area near the icons in the Navigator dialog .)

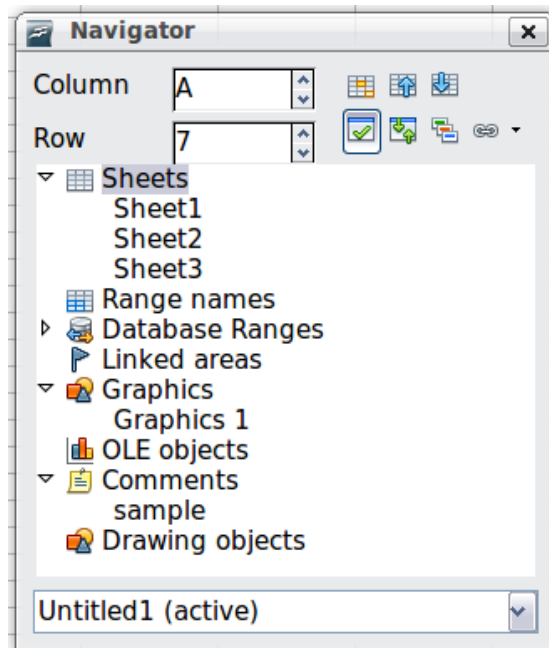



Figure 95: The Navigator in Calc

The Navigator displays lists of all the objects in a document, grouped into categories. If an indicator (plus sign or arrow) appears next to a category, at least one object of this kind exists. To open a category and see the list of items, click on the indicator.

To hide the list of categories and show only the icons at the top, click the **Contents** icon . Click this icon again to show the list.

Moving from cell to cell

In the spreadsheet, one cell normally has a darker black border. This black border indicates where the *focus* is (see Figure 96). If a group of cells is selected, they have a highlight color (usually gray), with the focus cell having a dark border.

Using the mouse

To move the focus using the mouse, simply move the mouse pointer to the cell where you want the focus to be and click the left mouse button. This changes the

focus to the new cell. This method is most useful when the two cells are a large distance apart.

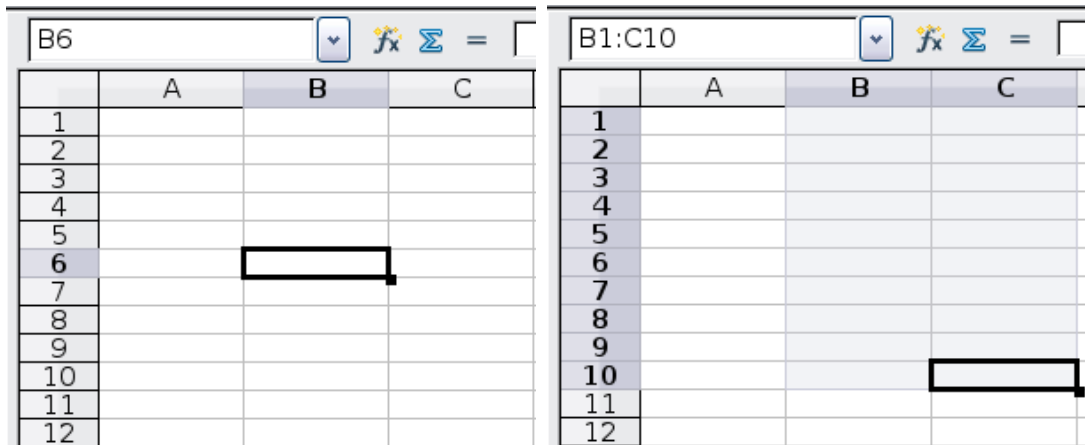

Figure 96. (Left) One selected cell and (right) a group of selected cells

Using the Tab and Enter keys

- Pressing *Enter* or *Shift+Enter* moves the focus down or up, respectively.
- Pressing *Tab* or *Shift+Tab* moves the focus to the right or to the left, respectively.

Using the arrow keys

Pressing the arrow keys on the keyboard moves the focus in the direction of the arrows.

Using Home, End, Page Up and Page Down

- *Home* moves the focus to the start of a row.
- *End* moves the focus to the column furthest to the right that contains data.
- *Page Down* moves the display down one complete screen and *Page Up* moves the display up one complete screen.
- Combinations of *Control* and *Alt* with *Home*, *End*, *Page Down*, *Page Up*, and the cursor keys move the focus of the current cell in other ways. See the Help or Appendix A (Keyboard Shortcuts) in the *Calc Guide* for details.

Tip

Use one of the four *Alt+Arrow* key combinations to resize a cell.

Customizing the Enter key

You can customize the direction in which the *Enter* key moves the focus, by selecting **Tools > Options > OpenOffice.org Calc > General**.

The four choices for the direction of the *Enter* key are shown on the right hand side of Figure 97. It can move the focus down, right, up, or left. Depending on the file being used or on the type of data being entered, setting a different direction can be useful.

The *Enter* key can also be used to switch into and out of editing mode. Use the first two options under *Input settings* in Figure 97 to change the *Enter* key settings.

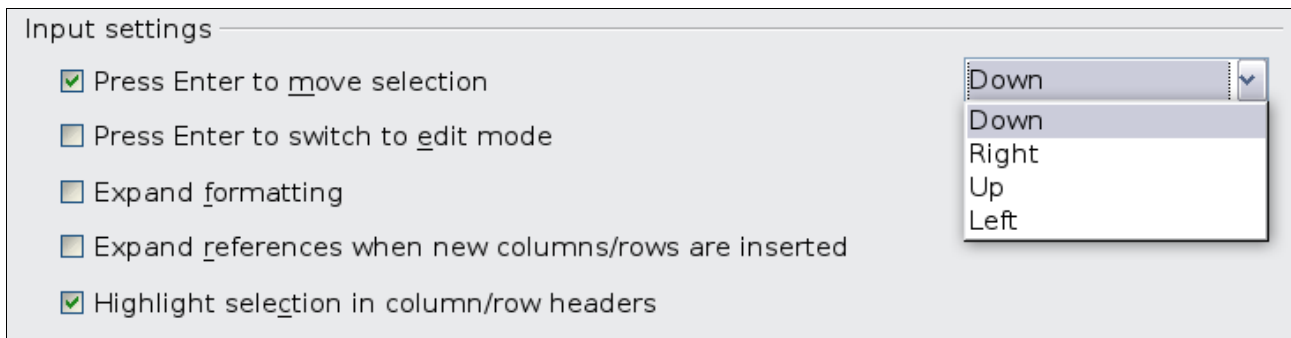

Figure 97: Customizing the effect of the Enter key

Moving from sheet to sheet

Each sheet in a spreadsheet is independent of the others, though they can be linked with references from one sheet to another. There are three ways to navigate between different sheets in a spreadsheet.

Using the Navigator

When the Navigator is open (Figure 95), double-clicking on any of the listed sheets selects the sheet.

Using the keyboard

Pressing *Control+Page Down* moves one sheet to the right and pressing *Control+Page Up* moves one sheet to the left.

Using the mouse

Clicking on one of the sheet tabs at the bottom of the spreadsheet selects that sheet.

If you have a lot of sheets, then some of the sheet tabs may be hidden behind the horizontal scroll bar at the bottom of the screen. If this is the case, then the four buttons at the left of the sheet tabs can move the tabs into view. Figure 98 shows how to do this.

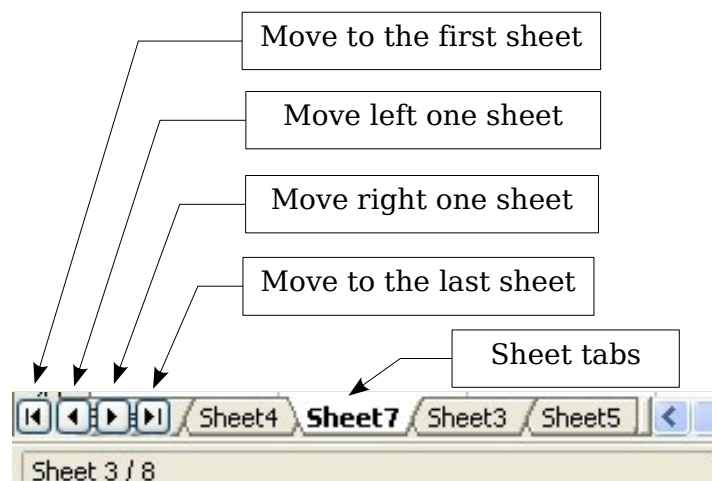

Figure 98. Sheet tab arrows

Notice that the sheets here are not numbered in order. Sheet numbering is arbitrary; you can name a sheet as you wish.

Note

The sheet tab arrows that appear in Figure 98 only appear if you have some sheet tabs that can not be seen. Otherwise, they will appear faded as in Figure 88.

Selecting items in a sheet or spreadsheet

Selecting cells

Cells can be selected in a variety of combinations and quantities.

Single cell

Left-click in the cell. The result will look like the left side of Figure 96. You can verify your selection by looking in the Name box.

Range of contiguous cells

A range of cells can be selected using the keyboard or the mouse.

To select a range of cells by dragging the mouse:

- 1) Click in a cell.
- 2) Press and hold down the left mouse button.
- 3) Move the mouse around the screen.
- 4) Once the desired block of cells is highlighted, release the left mouse button.

To select a range of cells without dragging the mouse:

- 1) Click in the cell which is to be one corner of the range of cells.
- 2) Move the mouse to the opposite corner of the range of cells.
- 3) Hold down the *Shift* key and click.

To select a range of cells without using the mouse:

- 1) Select the cell that will be one of the corners in the range of cells.
- 2) While holding down the *Shift* key, use the cursor arrows to select the rest of the range.

The result of any of these methods looks like the right side of Figure 96.

Tip

You can also directly select a range of cells using the Name box. Click into the Name Box as described in “Using a cell reference” on page 111. To select a range of cells, enter the cell reference for the upper left-hand cell, followed by a colon (:), and then the lower right-hand cell reference. For example, to select the range that would go from A3 to C6, you would enter *A3:C6*.

Range of non-contiguous cells

- 1) Select the cell or range of cells using one of the methods above.
- 2) Move the mouse pointer to the start of the next range or single cell.
- 3) Hold down the *Control* key and click or click-and-drag to select a range.
- 4) Repeat as necessary.

Selecting columns and rows

Entire columns and rows can be selected very quickly in OOo.

Single column or row

To select a single column, click on the column identifier letter (see Figure 88).

To select a single row, click on the row identifier number.

Multiple columns or rows

To select multiple columns or rows that are contiguous:

- 1) Click on the first column or row in the group.
- 2) Hold down the *Shift* key.
- 3) Click the last column or row in the group.

To select multiple columns or rows that are not contiguous:

- 1) Click on the first column or row in the group.
- 2) Hold down the *Control* key.
- 3) Click on all of the subsequent columns or rows while holding down the *Control* key.

Entire sheet

To select the entire sheet, click on the small box between the A column header and the 1 row header.

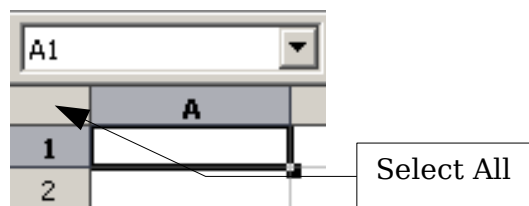

Figure 99. Select All box

You can also press *Control*+*A* to select the entire sheet.

Selecting sheets

You can select either one or multiple sheets. It can be advantageous to select multiple sheets at times when you want to make changes to many sheets at once.

Single sheet

Click on the sheet tab for the sheet you want to select. The active sheet becomes white (see Figure 100).

Multiple contiguous sheets

To select multiple contiguous sheets:

- 1) Click on the sheet tab for the first desired sheet.
- 2) Move the mouse pointer over the sheet tab for the last desired sheet.
- 3) Hold down the *Shift* key and click on the sheet tab.

All the tabs between these two sheets will turn white. Any actions that you perform will now affect all highlighted sheets.

Multiple non contiguous sheets

To select multiple non contiguous sheets:

- 1) Click on the sheet tab for the first sheet.
- 2) Move the mouse pointer over the second sheet tab.
- 3) Hold down the *Control* key and click on the sheet tab.
- 4) Repeat as necessary.

The selected tabs will turn white. Any actions that you perform will now affect all highlighted sheets.

All sheets

Right-click any one of the sheet tabs and choose **Select All Sheets** from the pop-up menu.

Working with columns and rows

Inserting columns and rows

Columns and rows can be inserted individually or in groups.

Note

When you insert a single new column, it is inserted to the *left* of the highlighted column. When you insert a single new row, it is inserted *above* the highlighted row.

Cells in the new columns or rows are formatted like the corresponding cells in the column or row before (or to the left of) which the new column or row is inserted.

Single column or row

Using the **Insert** menu:

- 1) Select the cell, column or row where you want the new column or row inserted.
- 2) Choose either **Insert > Columns** or **Insert > Rows**.

Using the mouse:

- 1) Select the cell, column or row where you want the new column or row inserted.
- 2) Right-click the header of the column or row.
- 3) Choose **Insert Rows** or **Insert Columns**.

Multiple columns or rows

Multiple columns or rows can be inserted at once rather than inserting them one at a time.

- 1) Highlight the required number of columns or rows by holding down the left mouse button on the first one and then dragging across the required number of identifiers.
- 2) Proceed as for inserting a single column or row above.

Deleting columns and rows

Columns and rows can be deleted individually or in groups.

Single column or row

A single column or row can only be deleted by using the mouse:

- 1) Select the column or row to be deleted.
- 2) Right-click on the column or row header.
- 3) Select **Delete Columns** or **Delete Rows** from the pop-up menu.

Multiple columns or rows

Multiple columns or rows can be deleted at once rather than deleting them one at a time.

- 1) Highlight the required number of columns or rows by holding down the left mouse button on the first one and then dragging across the required number of identifiers.
- 2) Proceed as for deleting a single column or row above.

Working with sheets

Like any other Calc element, sheets can be inserted, deleted, and renamed.

Inserting new sheets

There are several ways to insert a new sheet. The first step for all of the methods is to select the sheets that the new sheet will be inserted next to. Then any of the following options can be used.

- Choose **Insert > Sheet** from the menu bar.
- Right-click on the sheet tab and choose **Insert Sheet**.
- Click in an empty space at the end of the line of sheet tabs.

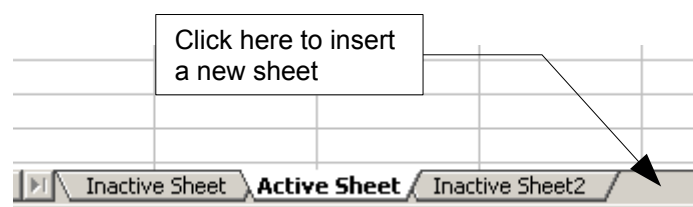

Figure 100. Creating a new sheet

Each method will open the Insert Sheet dialog (Figure 101). Here you can select whether the new sheet is to go before or after the selected sheet and how many sheets you want to insert. If you are inserting only one sheet, there is the opportunity to give the sheet a name.

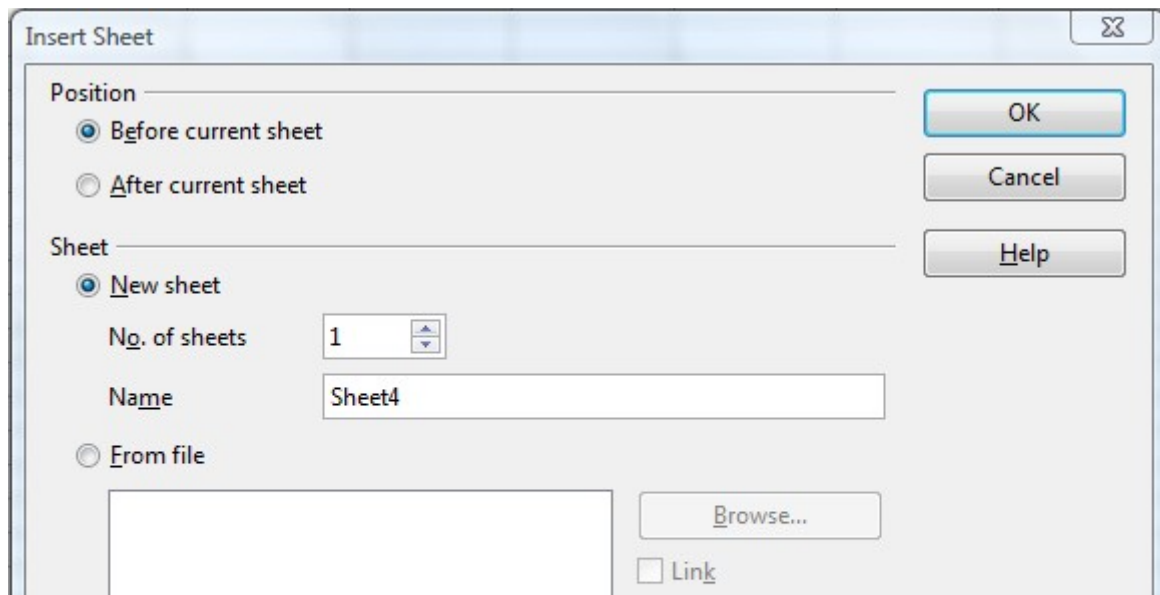

Figure 101. Insert Sheet dialog

Deleting sheets

Sheets can be deleted individually or in groups.

Single sheet

Right-click on the tab of the sheet you want to delete and choose **Delete Sheet** from the pop-up menu, or choose **Edit > Sheet > Delete** from the menu bar.

Multiple sheets

To delete multiple sheets, select them as described earlier, then either right-click over one of the tabs and select **Delete Sheet** from the pop-up menu, or choose **Edit > Sheet > Delete** from the menu bar.

Renaming sheets

The default name for the a new sheet is *SheetX*, where *X* is a number. While this works for a small spreadsheet with only a few sheets, it becomes awkward when there are many sheets.

To give a sheet a more meaningful name, you can:

- Enter the name in the Name box when you create the sheet, or
- Right-click on a sheet tab and choose **Rename Sheet** from the pop-up menu; replace the existing name with a better one.
- Double-click on a sheet tab to pop up the Rename Sheet dialog.

Note

Sheet names must start with either a letter or a number. Apart from the first character of the sheet name, allowed characters are letters, numbers, spaces, and the underline character. Attempting to rename a sheet with an invalid name will produce an error message.

Viewing Calc

Using zoom

Use the zoom function to change the view to show more or fewer cells in the window. For more about zoom, see Chapter 1 (Introducing OpenOffice.org) in this book.

Freezing rows and columns

Freezing locks a number of rows at the top of a spreadsheet or a number of columns on the left of a spreadsheet or both. Then when scrolling around within the sheet, any frozen columns and rows remain in view.

Figure 102 shows some frozen rows and columns. The heavier horizontal line between rows 3 and 14 and the heavier vertical line between columns C and H denote the frozen areas. Rows 4 through 13 and columns D through G have been scrolled off the page. The first three rows and columns remained because are frozen into place.

	A	B	C	H	I	J	K	L	M	N	O	P	Q	R	S	T
1				Safety Poster	Safety Contract	Safety Quiz 2	Unit Conv. Pop Qu	Element Quiz 1	Element Quiz 2	p. 36 15 & 16	Article Quiz	Lab #1	Chp. 1.1 #1-7	p. 35 ?'s	Chp. 1 Test	Penny Density
2		Total	Date	10-02	10-03	10-04	10-05	10-06	10-07	10-08	10-09	10-10	10-11	10-12	10-13	10-14
3	Average	267.5	Possible	28.0	1.0	3.0	12.0	18.0	28.0	4.0	6.0	6.0	3.5	4.0	78.0	11.0
14	78.6%	200.0	Smith, John	28.00	1.00	X	0.00	8.00	26.00	0.00	6.00	0.00	3.50	4.00	55.50	8.00
15	67.9%	181.5	Klein, Mike	28.00	1.00	1.00	11.50	8.00	6.00	0.00	5.00	6.00	3.50	3.50	47.50	10.00
16	72.7%	186.5	Johnson, Tom	27.00	1.00	3.00	0.00	13.00	6.00	0.00	6.00	6.00	3.50	3.00	47.50	9.00
17	82.6%	213.0	Doe, John	27.00	1.00	1.00	2.00	17.00	17.00	4.00	6.00	6.00	3.50	3.50	54.00	9.00
18	96.4%	258.0	Doe, Jane	28.00	1.00	3.00	9.00	16.00	28.00	4.00	6.00	6.00	3.50	4.00	79.50	10.00
19	67.3%	172.0	Kupfer, Peter	26.00	1.00	3.00	X	16.00	20.00	0.00	6.00	6.00	0.00	3.50	41.00	6.50
20	83.9%	224.5	Newton, Issac	28.00	1.00	3.00	6.00	15.00	23.00	4.00	6.00	6.00	3.50	3.50	57.50	9.00
21	80.6%	207.5	Lunak, Robert	26.00	0.00	2.00	5.00	15.00	17.00	4.00	6.00	6.00	3.50	0.00	62.50	9.00
22	78.1%	209.0	Matteson, Brittany	28.00	0.00	3.00	3.00	17.00	22.00	4.00	6.00	6.00	3.50	3.00	47.50	9.00
23	79.4%	212.5	Murphy, Kathleen	26.00	1.00	3.00	6.00	16.00	11.00	4.00	6.00	6.00	3.50	4.00	53.50	9.00

Figure 102. Frozen rows and columns

You can set the freeze point at a row, a column, or both a row and a column as in Figure 102.

Freezing single rows or columns

- 1) Click on the header for the row below where you want the freeze or for the column to the right of where you want the freeze.
- 2) Choose **Window > Freeze**.
A dark line appears, indicating where the freeze is put.

Freezing a row and a column

- 1) Click into the cell that is immediately below the row you want frozen and immediately to the right of the column you want frozen.
- 2) Choose **Window > Freeze**.

Two lines appear on the screen, a horizontal line above this cell and a vertical line to the left of this cell. Now as you scroll around the screen, everything above and to the left of these lines will remain in view.

Unfreezing

To unfreeze rows or columns, choose **Window > Freeze**. The check mark by **Freeze** will vanish.

Splitting the screen

Another way to change the view is by splitting the window, also known as splitting the screen. The screen can be split either horizontally or vertically or both. You can therefore have up to four portions of the spreadsheet in view at any one time.

Why would you want to do this? Imagine you have a large spreadsheet and one of the cells has a number in it which is used by three formulas in other cells. Using the split screen technique, you can position the cell containing the number in one section and each of the cells with formulas in the other sections. Then you can change the number in the cell and watch how it affects each of the formulas.

	A	B	C
1		Beta =	3.2000
2		A0 =	0.1000
5	A1=	Beta*A0*(1-A0)	0.2880
6	A2=	Beta*A1*(1-A1)	0.6562
7	A3=	Beta*A2*(1-A2)	0.7219
8	A4=	Beta*A3*(1-A3)	0.6424
9	A5=	Beta*A4*(1-A4)	0.7351
10	A6=	Beta*A5*(1-A5)	0.6231
11	A7=	Beta*A6*(1-A6)	0.7515
12	A8=	Beta*A7*(1-A7)	0.5975
13	A9=	Beta*A8*(1-A8)	0.7696
14	A10=	Beta*A9*(1-A9)	0.5675
15	A11=	Beta*A10*(1-A10)	0.7854

Figure 103. Split screen example

Splitting the screen horizontally

To split the screen horizontally:

- 1) Move the mouse pointer into the vertical scroll bar, on the right-hand side of the screen, and place it over the small button at the top with the black triangle. Immediately above this button you will see a thick black line.

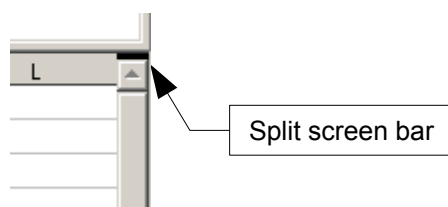

Figure 104. Split screen bar on vertical scroll bar

- 2) Move the mouse pointer over this line and it turns into a line with two arrows.



Figure 105. Split screen bar on vertical scroll bar with cursor

- 3) Hold down the left mouse button. A gray line appears, running across the page. Drag the mouse downwards and this line follows.
- 4) Release the mouse button and the screen splits into two views, each with its own vertical scroll bar. You can scroll the upper and lower parts independently.

Notice in Figure 103, the Beta and the A0 values are in the upper part of the window and other calculations are in the lower part. Thus you can make changes to the Beta and A0 values and watch their affects on the calculations in the lower half of the window.

Tip You can also split the screen using a menu command. Click in a cell immediately below and to the right of where you wish the screen to be split, and choose **Window > Split**.

Splitting the screen vertically

To split the screen vertically:

- 1) Move the mouse pointer into the horizontal scroll bar at the bottom of the screen and place it over the small button on the right with the black triangle. Immediately to the right of this button is a thick black line.

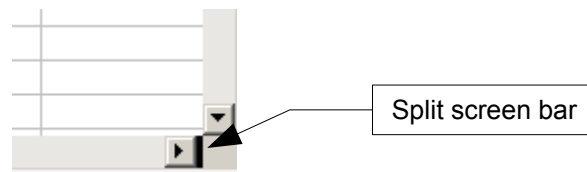

Figure 106: Split bar on horizontal scroll bar

- 2) Move the mouse pointer over this line and it turns into a line with two arrows.
- 3) Hold down the left mouse button, and a gray line appears, running up the page. Drag the mouse to the left and this line follows.
- 4) Release the mouse button and the screen is split into two views, each with its own horizontal scroll bar. You can scroll the left and right parts of the window independently.

Removing split views

To remove a split view, do any of the following:

- Double-click on each split line.
- Click on and drag the split lines back to their places at the ends of the scroll bars.
- Choose **Window > Split** to remove all split lines at the same time.

Entering data using the keyboard

Most data entry in Calc can be accomplished using the keyboard.

Entering numbers

Click in the cell and type in the number using the number keys on either the main keyboard or the numeric keypad.

To enter a negative number, either type a minus (-) sign in front of it or enclose it in parentheses (brackets), like this: (1234).

By default, numbers are right-aligned and negative numbers have a leading minus symbol.

Note

If a number beginning with 0 is entered in to a cell, Calc will drop the 0 (for example 01234 becomes 1234).

To enter a number and retain the leading 0, right-click on the cell and choose **Format Cells > Numbers**. In the Format Cells dialog, under *Options* select the required number of *Leading zeros*.

The number selected for leading zeros needs to be one higher than the digits in a number. For example, if the number is 1234, the number entered for the leading zero will be 5.

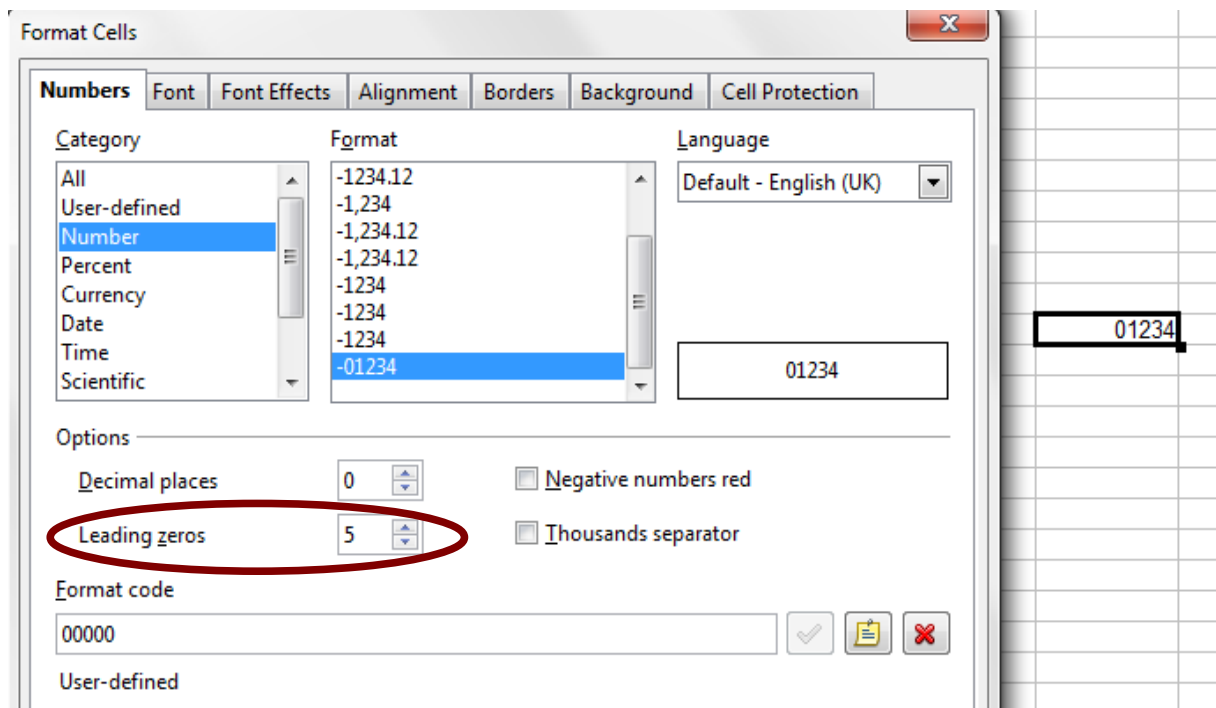

Figure 107: Adjusting leading zeros

Entering text

Click in the cell and type the text. Text is left-aligned by default.

Entering numbers as text

A number can be entered as text to preserve a leading zero by entering an apostrophe before the number, like this: '01481.

The data is now regarded as text by Calc and displayed exactly as entered. Typically, formulas will treat the entry as a zero and functions will ignore it. Take care that the cell containing the number is not used in a formula.

Note

If “smart quotes” are used for apostrophes, the apostrophe remains visible in the cell.

To choose the type of apostrophe, use **Tools > AutoCorrect > Custom Quotes**. The selection of the apostrophe type affects both Calc and Writer.

Entering dates and times

Select the cell and type the date or time. You can separate the date elements with a slant (/) or a hyphen (-) or use text such as 10 Oct 03. Calc recognizes a variety of date formats. You can separate time elements with colons such as 10:43:45.

Deactivating automatic changes

Calc automatically applies many changes during data input, unless you deactivate those changes. You can also immediately undo any automatic changes with *Ctrl+Z*.

AutoCorrect changes

Automatic correction of typing errors, replacement of straight quotation marks by curly (custom) quotes, and starting cell content with an uppercase (capital letter) are controlled by **Tools > AutoCorrect Options**. Go to the *Custom Quotes*, *Options*, or *Replace* tabs to deactivate any of the features that you do not want. On the *Replace* tab, you can also delete unwanted word pairs and add new ones as required.

AutoInput

When you are typing in a cell, Calc automatically suggests matching input found in the same column. To turn the AutoInput on and off, set or remove the check mark in front of **Tools > Cell Contents > AutoInput**.

SAutomatic date conversion

Calc automatically converts certain entries to dates. To ensure that an entry that looks like a date is interpreted as text, type an apostrophe at the beginning of the entry. The apostrophe is not displayed in the cell.

Speeding up data entry

Entering data into a spreadsheet can be very labor-intensive, but Calc provides several tools for removing some of the drudgery from input.

The most basic ability is to drop and drag the contents of one cell to another with a mouse. Calc also includes several other tools for automating input, especially of repetitive material. They include the Fill tool, selection lists, and the ability to input information into multiple sheets of the same document.

Using the Fill tool on cells

At its simplest, the Fill tool is a way to duplicate existing content. Start by selecting the cell to copy, then drag the mouse in any direction (or hold down the Shift key and click in the last cell you want to fill), and then choose **Edit > Fill** and the direction in which you want to copy: Up, Down, Left or Right.

Caution



Choices that are not available are grayed out, but you can still choose the opposite direction from what you intend, which could cause you to overwrite cells accidentally.

Tip

A shortcut way to fill cells is to grab the “handle” in the lower right-hand corner of the cell and drag it in the direction you want to fill. If the cell contains a number, the number will fill in series. If the cell contains text, the same text will fill in the direction you chose.

	A	B
1	Original	
2		
3		
4		
5		
6		
7		
8		
9		
10		
11		
12		

	A	B
1	Original	
2	Original	
3	Original	
4	Original	
5	Original	
6	Original	
7	Original	
8	Original	
9	Original	
10	Original	
11		
12		

Figure 108: Using the Fill tool

Using a fill series

A more complex use of the Fill tool is to use a fill series. The default lists are for the full and abbreviated days of the week and the months of the year, but you can create your own lists as well.

To add a fill series to a spreadsheet, select the cells to fill, choose **Edit > Fill > Series**. In the Fill Series dialog (Figure 110), select **AutoFill** as the *Series type*, and enter as the *Start value* an item from any defined series. The selected cells then fill in the other items on the list sequentially, repeating from the top of the list when they reach the end of the list.

	A	B
1	January	
2	February	
3	March	
4	April	
5	May	
6	June	
7	July	
8	August	
9	September	
10	October	
11	November	
12	December	
13		

Figure 109: Result of fill series selection shown in Figure 110

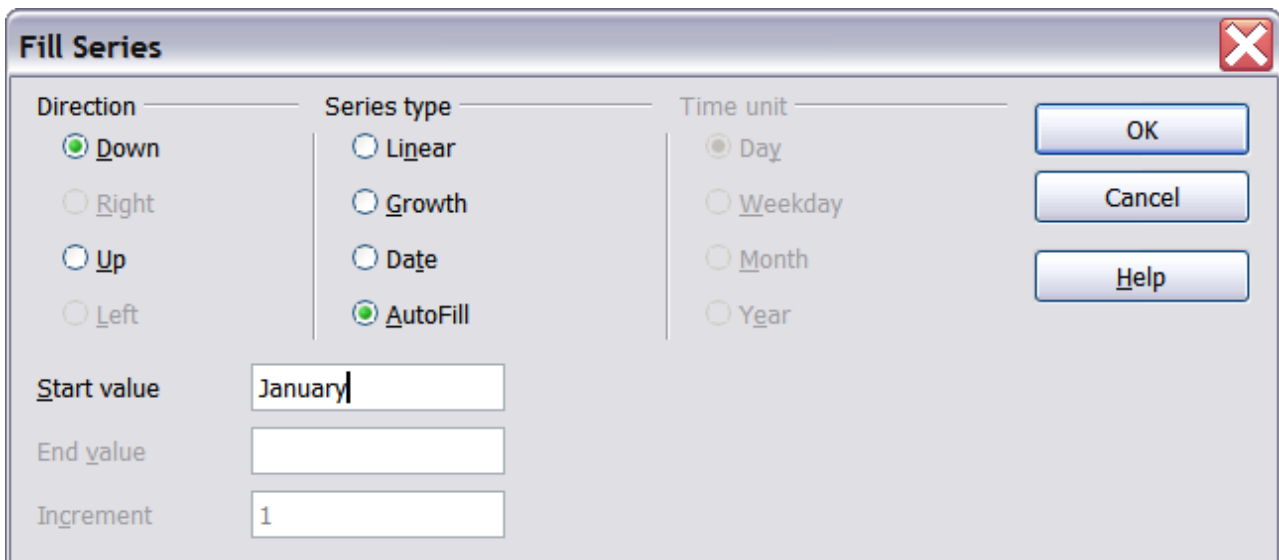

Figure 110: Specifying the start of a fill series (result is in Figure 109)

You can also use **Edit > Fill > Series** to create a one-time fill series for numbers by entering the start and end values and the increment. For example, if you entered start and end values of 1 and 7 with an increment of 2, you would get the sequence of 1, 3, 5, 7.

In all these cases, the Fill tool creates only a momentary connection between the cells. Once they are filled, the cells have no further connection with one another.

Defining a fill series

To define your own fill series:

- 1) Go to **Tools > Options > OpenOffice.org Calc > Sort Lists**. This dialog shows the previously-defined series in the *Lists* box on the left, and the contents of the highlighted list in the *Entries* box.

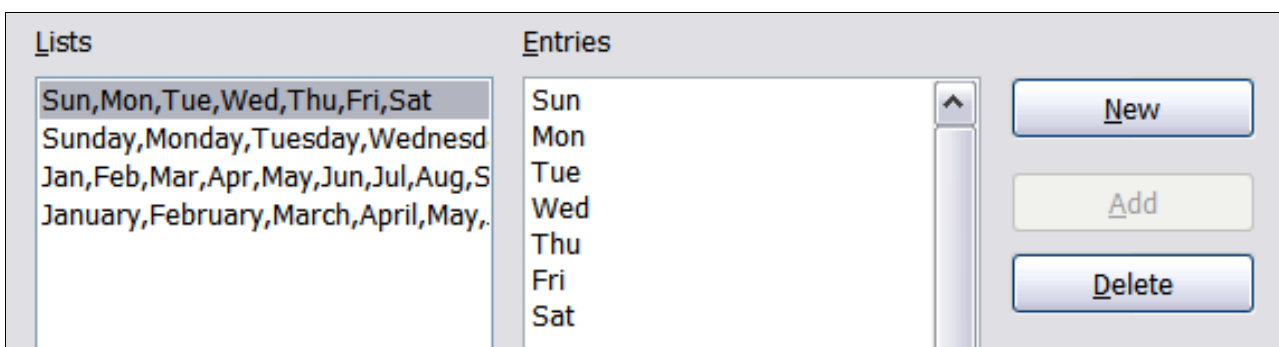

Figure 111: Predefined fill series

- 2) Click **New**. The *Entries* box is cleared.
- 3) Type the series for the new list in the *Entries* box (one entry per line). Click **Add**. The new list will now appear in the *Lists* box.
- 4) Click **OK** at the bottom of the dialog to save the new list.

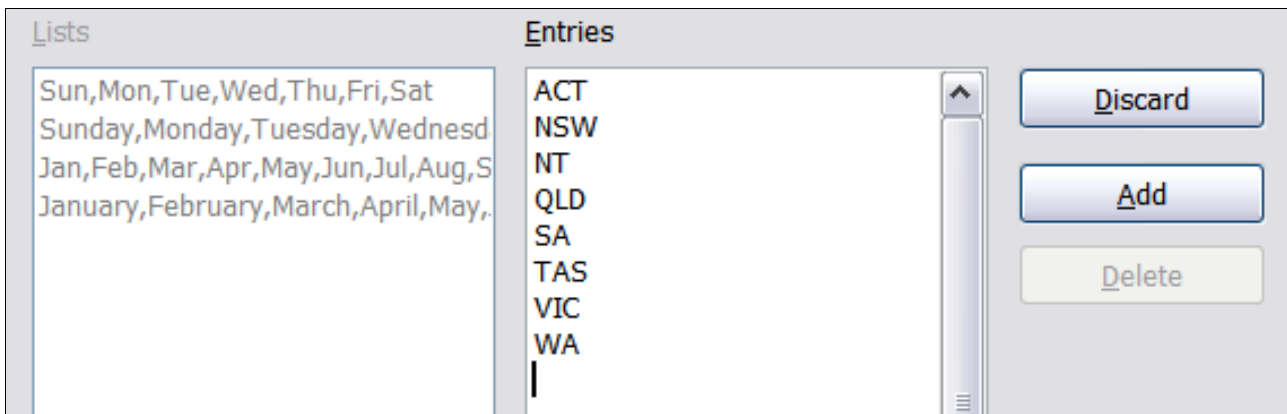
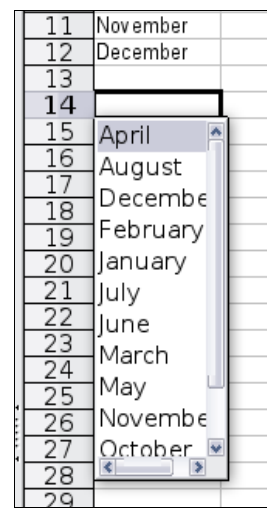

Figure 112: Defining a new fill series

Using selection lists

Selection lists are available only for text, and are limited to using only text that has already been entered in the same column.

To use a selection list, select a blank cell and press *Ctrl+D*. A drop-down list appears of any cell in the same column that either has at least one text character or whose format is defined as Text. Click on the entry you require.



Sharing content between sheets

You might want to enter the same information in the same cell on multiple sheets, for example to set up standard listings for a group of individuals or organizations. Instead of entering the list on each sheet individually, you can enter it in all the sheets at once. To do this, select all the sheets (**Edit > Sheet > Select**), then enter the information in the current one.

Caution



This technique overwrites any information that is already in the cells on the other sheets—without any warning. For this reason, when you are finished, be sure to deselect all the sheets except the one you want to edit. (*Ctrl+click* on a sheet tab to select or deselect the sheet.)

Validating cell contents

When creating spreadsheets for other people to use, you may want to make sure they enter data that is valid or appropriate for the cell. You can also use validation in your own work as a guide to entering data that is either complex or rarely used.

Fill series and selection lists can handle some types of data, but they are limited to predefined information. To validate new data entered by a user, select a cell and use **Data > Validity** to define the type of contents that can be entered in that cell. For example, a cell might require a date or a whole number, with no alphabetic characters or decimal points; or a cell may not be left empty.

Depending on how validation is set up, the tool can also define the range of contents that can be entered and provide help messages that explain the content rules you have set up for the cell and what users should do when they enter invalid content. You can also set the cell to refuse invalid content, accept it with a warning, or start a macro when an error is entered.

See Chapter 2 (Entering, Editing and Formatting Data) in the *Calc Guide* for more information.

Editing data

Editing data is done in much the same way as entering data. The first step is to select the cell containing the data to be edited.

Removing data from a cell

Data can be removed (deleted) from a cell in several ways.

Removing data only

The data alone can be removed from a cell without removing any of the formatting of the cell. Click in the cell to select it, and then press the *Backspace* key.

Removing data and formatting

The data and the formatting can be removed from a cell at the same time. Press the *Delete* key (or right-click and choose **Delete Contents**, or use **Edit > Delete Contents**) to open the **Delete Contents** dialog. From this dialog, the different aspects of the cell can be deleted. To delete everything in a cell (contents and format), check **Delete all**.

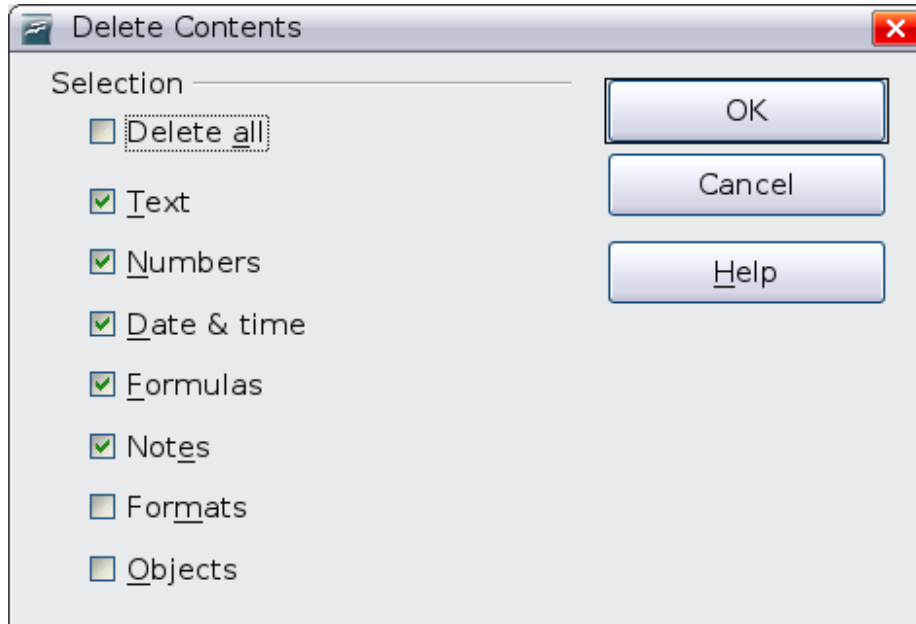

Figure 113: Delete Contents dialog

Replacing all the data in a cell

To remove data and insert new data, simply type over the old data. The new data will retain the original formatting.

Changing part of the data in a cell

Sometimes it is necessary to change the contents of cell without removing all of the contents, for example if the phrase “See Dick run” is in a cell and it needs to be changed to “See Dick run fast.” It is often useful to do this without deleting the old cell contents first.

The process is the similar to the one described above, but you need to place the cursor inside the cell. You can do this in two ways.

Using the keyboard

After selecting the appropriate cell, press the *F2* key and the cursor is placed at the end of the cell. Then use the keyboard arrow keys to move the cursor through the text in the cell.

Using the mouse

Using the mouse, either double-click on the appropriate cell (to select it and place the cursor in it for editing), or single-click to select the cell and then move the mouse pointer up to the input line and click into it to place the cursor for editing.

Formatting data

The data in Calc can be formatted in several ways. It can either be edited as part of a cell style so that it is automatically applied, or it can be applied manually to the cell. Some manual formatting can be applied using toolbar icons. For more control and extra options, select the appropriate cell or cells, right-click on it, and select **Format Cells**. All of the format options are discussed below.

Note

All the settings discussed in this section can also be set as a part of the cell style. See Chapter 4 (Using Styles and Templates in Calc) in the *Calc Guide* for more information.

Formatting multiple lines of text

Multiple lines of text can be entered into a single cell using automatic wrapping or manual line breaks. Each method is useful for different situations.

Using automatic wrapping

To set text to wrap at the end of the cell, right-click on the cell and select **Format Cells** (or choose **Format > Cells** from the menu bar, or press *Ctrl+1*). On the *Alignment* tab (Figure 114), under Properties, select **Wrap text automatically** and click **OK**. The results are shown in Figure 115.

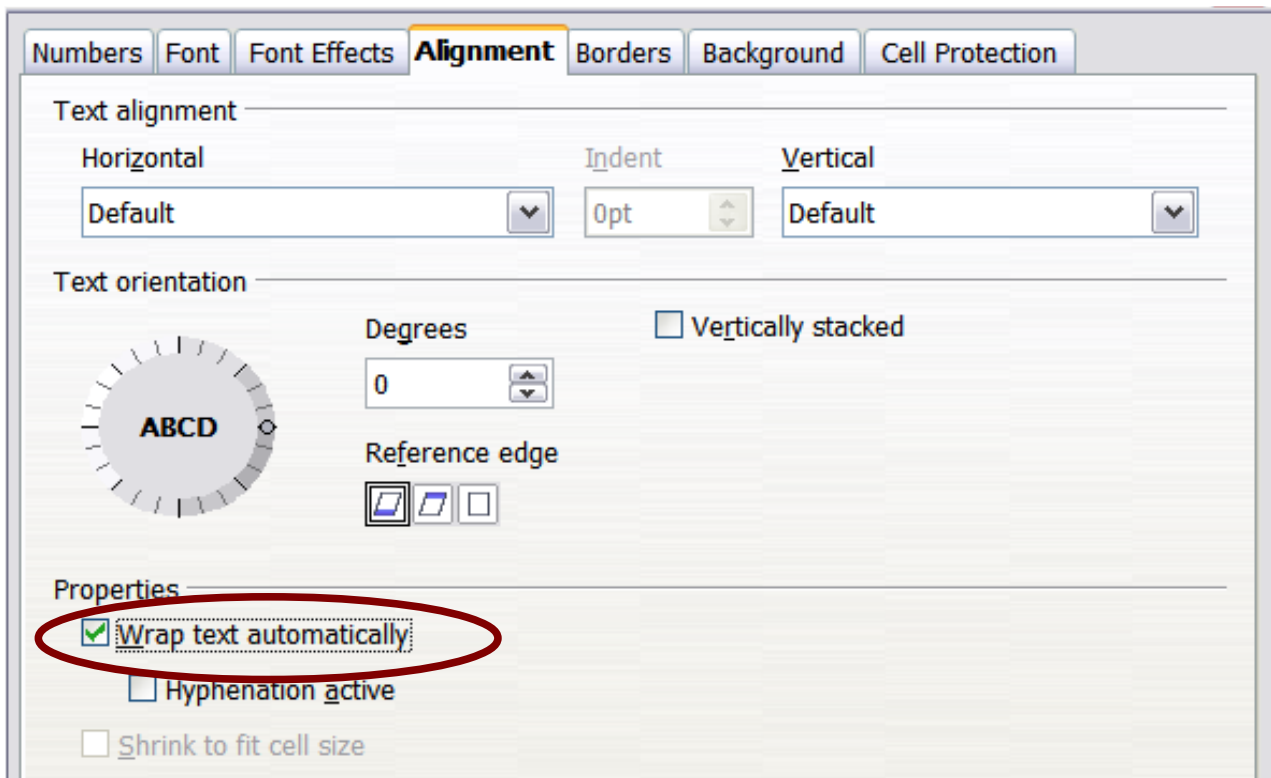

Figure 114: Format Cells > Alignment dialog

	This cell is not set to wrap text automatically. So they text will just keep going, and goir					
	This cell is set to wrap text automatically. The cell will fit more text without getting wider.					

Figure 115: Automatic text wrap

Using manual line breaks

To insert a manual line break while typing in a cell, press *Ctrl+Enter*. This method does not work with the cursor in the input line. When editing text, first double-click the cell, then single-click at the position where you want the line break.

When a manual line break is entered, the cell width does not change. Figure 116 shows the results of using two manual line breaks after the first line of text.

	This line contains manual line breaks.				
	Lines can be spaced out this way.				
	Also, the cell width doesn't change but the text can go on.				

Figure 116: Cell with manual line breaks

Shrinking text to fit the cell

The font size of the data in a cell can automatically adjust to fit in a cell. To do this, select the **Shrink to fit cell size** option in the Format Cells dialog (Figure 114). Figure 117 shows the results.

2			
3	The quick brown fox jumps over the lazy dog.	The quick brown fox jumps over the lazy dog.	The quick brown fox jumps over the lazy dog.
4			

Figure 117: Shrinking font size to fit cells

Formatting numbers

Several different number formats can be applied to cells by using icons on the Formatting toolbar. Select the cell, then click the relevant icon.



Figure 118: Number format icons. Left to right: currency, percentage, date, exponential, standard, add decimal place, delete decimal place.

For more control or to select other number formats, use the *Numbers* tab (Figure 119) of the Format Cells dialog:

- Apply any of the data types in the Category list to the data.
- Control the number of decimal places and leading zeros.
- Enter a custom format code.

The Language setting controls the local settings for the different formats such as the date order and the currency marker.

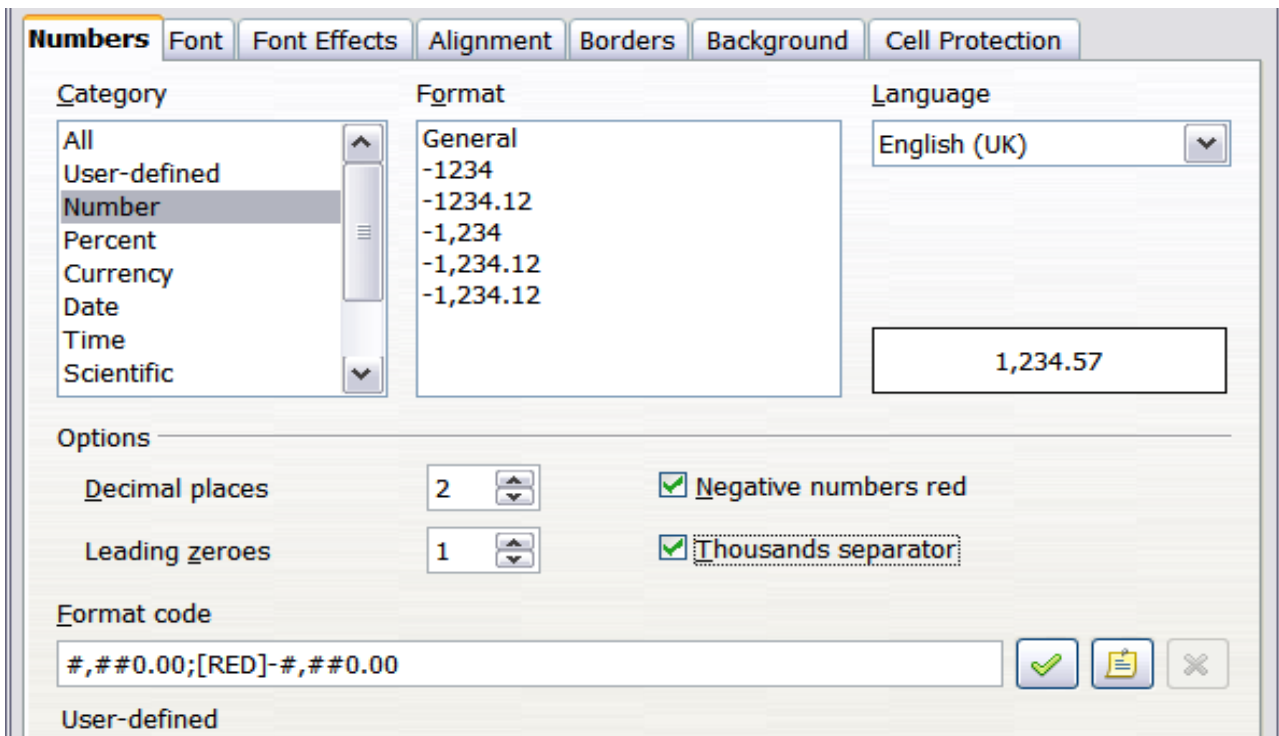

Figure 119: Format Cells > Numbers

Formatting the font

To quickly choose the font used in a cell, select the cell, then click the arrow next to the Font Name box on the Formatting toolbar and choose a font from the list.

Tip

To choose whether to show the font names in their font or in plain text, go to **Tools > Options > OpenOffice.org > View** and select or deselect the Show preview of fonts option in the Font Lists section. For more information, see Chapter 2 (Setting Up OpenOffice.org).

To choose the size of the font, click the arrow next to the Font Size box on the Formatting toolbar. For other formatting, you can use the Bold, Italic, or Underline icons.

To choose a font color, click the arrow next to the Font Color icon to display a color palette. Click on the required color.

(To define custom colors, use **Tools > Options > OpenOffice.org > Colors**. See Chapter 2.)

To specify the language of the cell (useful because it allows different languages to exist in the same document and be spell checked correctly), use the *Font* tab of the Format Cells dialog. Use the *Font Effects* tab to set other font characteristics. See Chapter 4 (Using Styles and Templates in Calc) of the *Calc Guide* for more information.

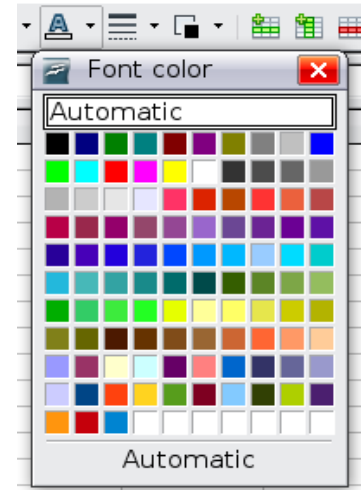

Formatting the cell borders

To add a border to a cell (or group of selected cells) click on the Borders icon on the formatting toolbar, and select one of the border options displayed in the palette.

To quickly choose a line style and color for the borders of a cell, click the small arrows next to the Line Style and Line Color icons on the Formatting toolbar. In each case, a palette of choices is displayed.

For more controls, including the spacing between the cell borders and the text, use the *Borders* tab of the Format Cells dialog. There you can also define a shadow. See Chapter 4 (Using Styles and Templates in Calc) of the *Calc Guide* for details.

Note

The cell border properties apply to a cell, and can only be changed if you are editing that cell. For example, if cell C3 has a top border (which would be equivalent visually to a bottom border on C2), that border can only be removed by selecting C3. It cannot be removed in C2.

Formatting the cell background

To quickly choose a background color for a cell, click the small arrow next to the Background Color icon on the Formatting toolbar. A palette of color choices, similar to the Font Color palette, is displayed.

(To define custom colors, use **Tools > Options > OpenOffice.org > Colors**. See Chapter 2 for more information.)

You can also use the *Background* tab of the Format Cells dialog. See Chapter 4 (Using Styles and Templates in Calc) of the *Calc Guide* for details.

Autoformatting cells and sheets

You can use the AutoFormat feature to quickly apply a set of cell formats to a sheet or a selected cell range.

- 1) Select the cells, including the column and row headers, that you want to format.
- 2) Choose **Format > AutoFormat**.

Note

The AutoFormat feature can only be applied if the selected set of cells consist of at least 3 columns and 3 rows and includes the column and row headers.

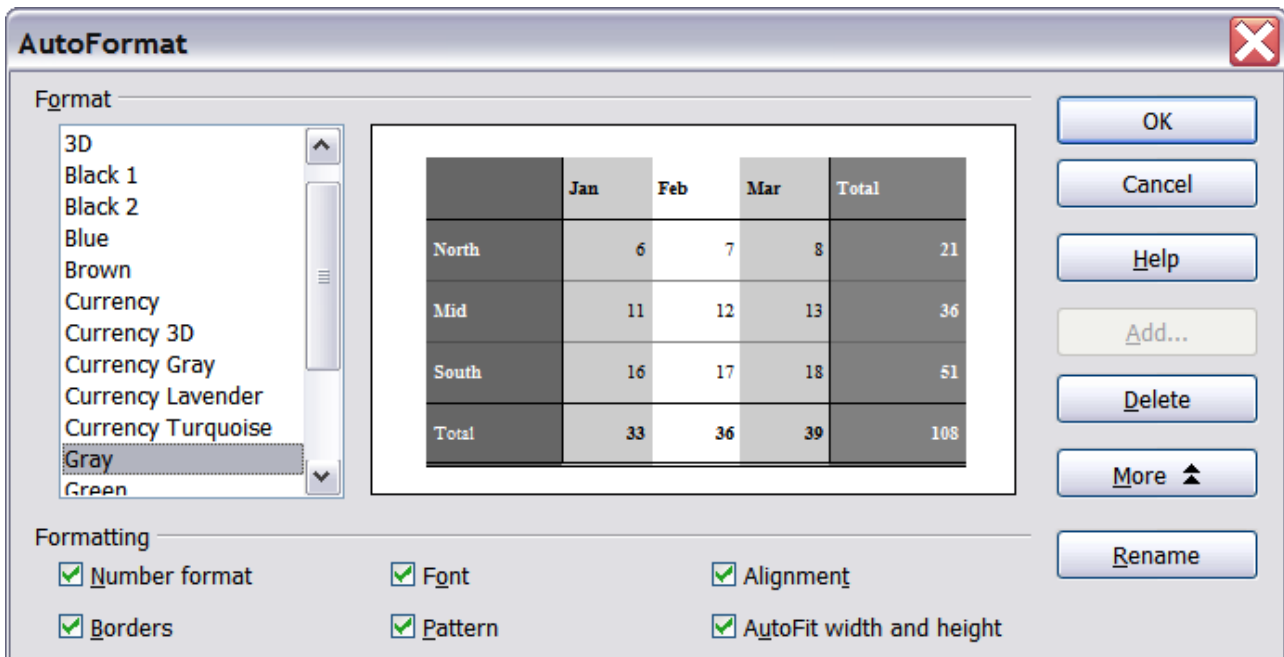

Figure 120: Choosing an AutoFormat

- 3) To select which properties (number format, font, alignment, borders, pattern, autofit width and height) to include in an AutoFormat, click **More**. Select or deselect the required options.
- 4) Click **OK**.

If you do not see any change in color of the cell contents, choose **View > Value Highlighting** from the menu bar.

Defining a new AutoFormat

You can define a new AutoFormat that is available to all spreadsheets.

- 1) Format a sheet (in the style for the new AutoFormat).
- 2) Choose **Edit > Select All**.
- 3) Choose **Format > AutoFormat**. The **Add** button is now active.
- 4) Click **Add**.
- 5) In the *Name* box of the Add AutoFormat dialog, type a meaningful name for the new format.
- 6) Click **OK** to save. The new format is now available in the *Format* list in the AutoFormat dialog.

Formatting spreadsheets using themes

Calc comes with a predefined set of formatting themes that you can apply to your spreadsheets.

It is not possible to add themes to Calc, and they cannot be modified. However, you can modify their styles after you apply them to a spreadsheet.

To apply a theme to a spreadsheet:

- 1) Click the **Choose Themes** icon in the Tools toolbar. If this toolbar is not visible, you can show it using **View > Toolbars > Tools**.
The Theme Selection dialog appears. This dialog lists the available themes for the whole spreadsheet.



- 2) In the Theme Selection dialog, select the theme that you want to apply to the spreadsheet.
As soon as you select a theme, some of the properties of the custom styles are applied to the open spreadsheet and are immediately visible.
- 3) Click **OK**. If you wish, you can now go to the Styles and Formatting window to modify specific styles. These modifications do not change the theme; they only change the appearance of this specific spreadsheet document.

Using conditional formatting

You can set up cell formats to change depending on conditions that you specify. For example, in a table of numbers, you can show all the values above the average in green and all those below the average in red.

Conditional formatting depends upon the use of styles, and the AutoCalculate feature (**Tools > Cell Contents > AutoCalculate**) must be enabled. See Chapter 2 (Entering, Editing, and Formatting Data) in the *Calc Guide* for details.

Hiding and showing data

When elements are hidden, they are neither visible nor printed, but can still be selected for copying if you select the elements around them. For example, if column B is hidden, it is copied when you select columns A and C. When you need a hidden element again, you can reverse the process, and show the element.

To hide or show sheets, rows, and columns, use the options on the Format menu or the right-click (context) menu. For example, to hide a row, first select the row, and then choose **Format > Row > Hide** (or right-click and choose **Hide**).

To hide or show selected cells, choose **Format > Cells** from the menu bar (or right-click and choose **Format Cells**). On the Format Cells dialog, go to the *Cell Protection* tab.

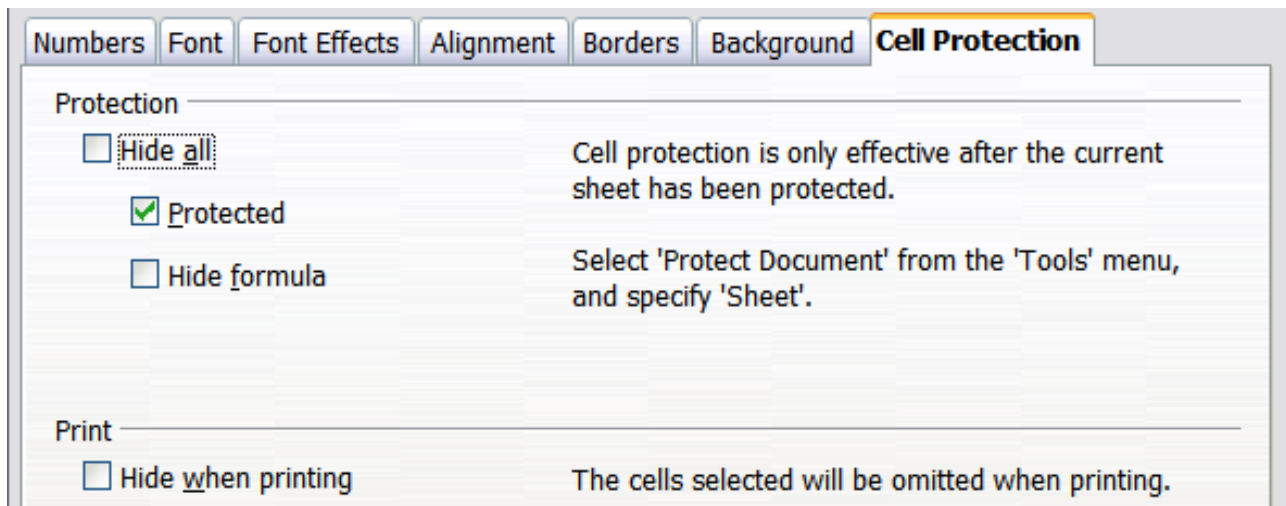

Figure 121: Hiding or showing cells

Outline group controls

If you are continually hiding and showing the same cells, you can simplify the process by creating *outline groups*, which add a set of controls for hiding and showing the cells in the group that are quick to use and always available.

If the contents of cells falls into a regular pattern, such as four cells followed by a total, then you can use **Data > Group and Outline > AutoOutline** to have Calc add outline controls based on the pattern. Otherwise, you can set outline groups manually by selecting the cells for grouping, then choosing **Data > Group and Outline > Group**. On the Group dialog, you can choose whether to group the selected cells by rows or columns.

When you close the dialog, the outline group controls are visible between either the row or column headers and the edges of the editing window. The controls resemble the tree-structure of a file-manager in appearance, and can be hidden by selecting **Data > Outline > Hide Details**. They are strictly for on screen use, and do not print.

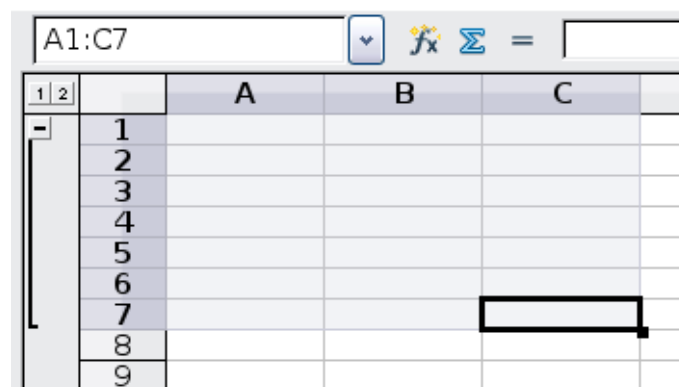

Figure 122: Outline group controls

The basic outline controls have plus or minus signs at the start of the group to show or hide hidden cells. However, if outline groups are nested, the controls have numbered buttons for hiding different levels.

If you no longer need a group, place the mouse cursor in any cell in it and select **Data > Group and Outline > Ungroup**. To remove all groups on a sheet, select **Data > Group and Outline > Remove**.

Filtering which cells are visible

A filter is a list of conditions that each entry has to meet in order to be displayed. You can set three types of filters from the **Data > Filter** sub-menu.

Automatic filters add a drop-down list to the top row of a column that contains commonly used filters. They are quick and convenient and are useful with text and with numbers, because the list includes every unique entry in the selected cells.

In addition to these unique entries, automatic filters include the option to display all entries, the ten highest numerical values, and all cells that are empty or not-empty, as well as a standard filter. The automatic filters are somewhat limited. In particular, they do not allow regular expressions, so you cannot use them to display cell contents that are similar, but not identical.

Standard filters are more complex than automatic filters. You can set as many as three conditions as a filter, combining them with the operators AND and OR. Standard filters are mostly useful for numbers, although a few of the conditional operators, such as = and < > can also be useful for text.

Other conditional operators for standard filters include options to display the largest or smallest values, or a percentage of them. Useful in themselves, standard filters take on added value when used to further refine automatic filters.

Advanced filters are structured similarly to standard filters. The differences are that advanced filters are not limited to three conditions, and their criteria are not entered in a dialog. Instead, advanced filters are entered in a blank area of a sheet, then referenced by the advanced filter tool to apply them.

Sorting records

Sorting arranges the visible cells on the sheet. In Calc, you can sort by up to three criteria, which are applied one after another. Sorts are handy when you are searching for a particular item, and become even more powerful after you have filtered data.

In addition, sorting is often useful when you add new information. When a list is long, it is usually easier to add new information at the bottom of the sheet, rather than adding rows in the proper places. After you have added information, you can then sort it to update the sheet.

Highlight the cells to be sorted, then select **Data > Sort** to open the Sort dialog (or click the Sort Ascending or Sort Descending toolbar buttons). Using the dialog, you can sort the selected cells using up to three columns, in either ascending (A-Z, 1-9) or descending (Z-A, 9-1) order.

On the *Options* tab of the Sort dialog, you can choose the following options:

Case sensitive

If two entries are otherwise identical, one with an upper case letter is placed before one with a lower case letter in the same position.

Range contains column labels

Does not include the column heading in the sort.

Include formats

A cell's formatting is moved with its contents. If formatting is used to distinguish different types of cells, then use this option.

Copy sort results to

Sets a spreadsheet address to which to copy the sort results. If a range is specified that does not have the necessary number of cells, then cells are added. If a range contains cells that already have content, then the sort fails.

Custom sort order

Select the box, then choose one of the sort orders defined in **Tools > Options > Spreadsheet > Sort Lists** from the drop-down list.

Direction

Sets whether rows or columns are sorted. The default is to sort by columns unless the selected cells are in a single column.

Printing

Printing from Calc is much the same as printing from other OOo components (see Chapter 10), but some details are different, especially regarding preparation for printing.

Using print ranges

Print ranges have several uses, including printing only a specific part of the data or printing selected rows or columns on every page. For more about using print ranges, see Chapter 6 (Printing, Exporting, and E-mailing) in the *Calc Guide*.

Defining a print range

To define a new print range or modify an existing print range:

- 1) Highlight the range of cells that comprise the print range.
- 2) Choose **Format > Print Ranges > Define**.

The page break lines display on the screen.

Tip

You can check the print range by using **File > Page Preview**. OOo will only display the cells in the print range.

Adding to the print range

After defining a print range, you can add more cells to it. This allows multiple, separate areas of the same sheet to be printed, while not printing the whole sheet.

After you have defined a print range:

- 1) Highlight the range of cells to be added to the print range.
- 2) Choose **Format > Print Ranges > Add**. This adds the extra cells to the print range.

The page break lines no longer display on the screen.

Note

The additional print range will print as a separate page, even if both ranges are on the same sheet.

Removing a print range

It may become necessary to remove a defined print range, for example if the whole sheet needs to be printed later.

Choose **Format > Print Ranges > Remove**. This removes *all* defined print ranges on the sheet. After the print range is removed, the default page break lines will appear on the screen.

Editing a print range

At any time, you can directly edit the print range, for example to remove or resize part of the print range. Choose **Format > Print Ranges > Edit**.

Selecting the page order, details, and scale

To select the page order, details, and scale to be printed:

- 1) Choose **Format > Page** from the main menu.
- 2) Select the **Sheet** tab.
- 3) Make your selections, and then click **OK**.

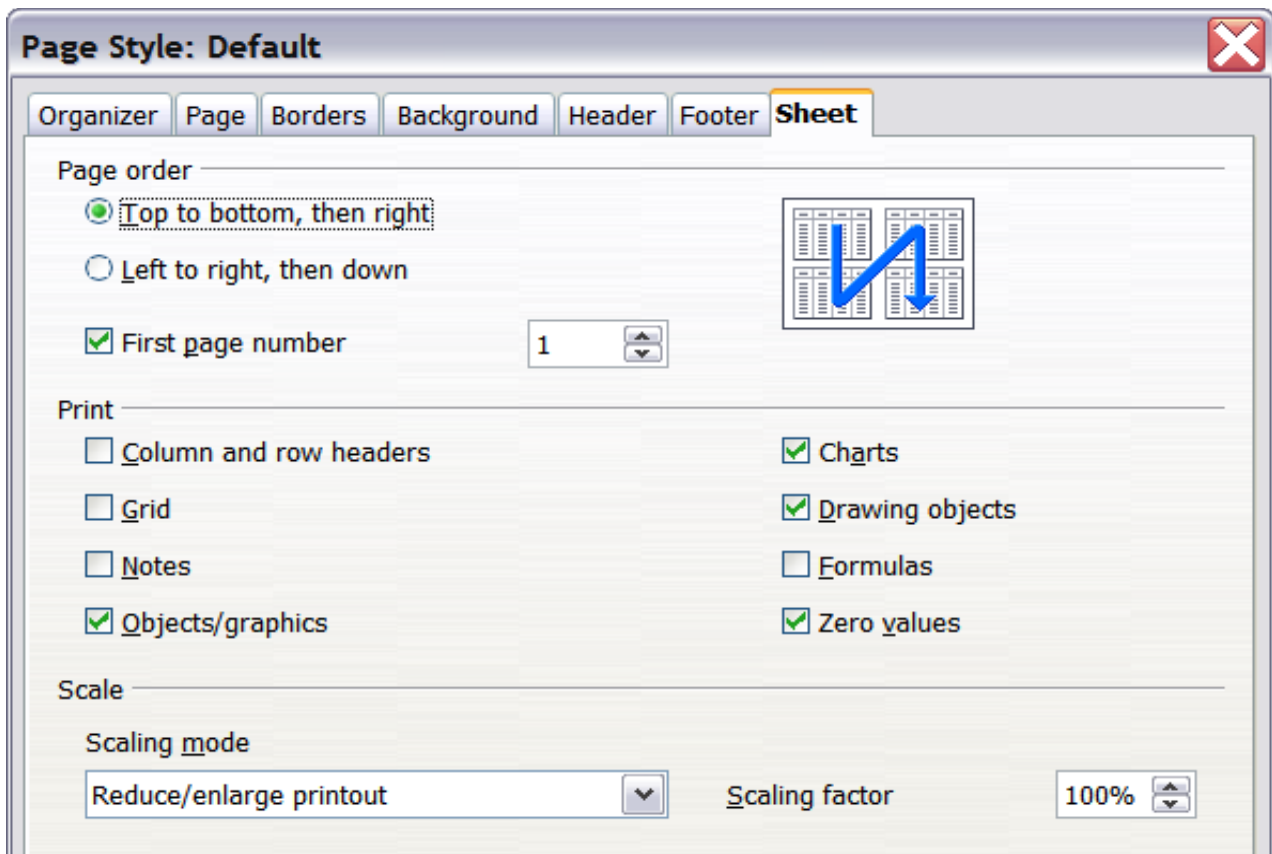



Figure 123. The Sheet tab of the Page Style dialog

Page Order

When a sheet will print on more than one page (of paper) you can set the order in which pages print. This is especially useful in a large document; for example, controlling the print order can save time if you have to collate the document a certain way. The two available options are shown below.

Top to bottom, then right	
Left to right, then down	

Details

You can specify which details to print. These details include:

- Row and column headers
- Sheet grid—prints the borders of the cells as a grid
- Comments—prints the comments defined in your spreadsheet on a separate page, along with the corresponding cell reference
- Objects and graphics
- Charts
- Drawing objects
- Formulas—prints the formulas contained in the cells, instead of the results
- Zero Values—prints cells with a zero value

Note

Remember that since the print detail options are a part of the page's properties, they are also a part of the page style's properties. Therefore, different page styles can be set up to quickly change the print properties of the sheets in the spreadsheet.

Scale

Use the scale features to control the number of pages the data will print on. This can be useful if a large amount of data needs to be printed compactly or if you want the text enlarged to make it easier to read.

- Reduce/Enlarge printout—scales the data in the printout either larger or smaller. For example if a sheet would normally print out as four pages (two high and two wide), a scaling of 50% would print as one page (both width and height are halved).
- Fit print range(s) on number of pages—defines exactly how many pages the printout will take up. This option will only reduce a printout, it will not enlarge it. To enlarge a printout, the reduce/enlarge option must be used.
- Fit print range(s) to width/height—defines how high and wide the printout will be, in pages.

Printing rows or columns on every page

If a sheet is printed on multiple pages, you can set up certain rows or columns to repeat on each printed page.

For example, if the top two rows of the sheet as well as column A need to be printed on all pages, do the following:

- 1) Choose **Format > Print Ranges > Edit**. On the Edit Print Ranges dialog, type the rows in the text entry box under *Rows to repeat*. For example, to repeat rows 1 and 2, type **\$1:\$2**. This automatically changes *Rows to repeat* from, **- none -** to **- user defined -**.

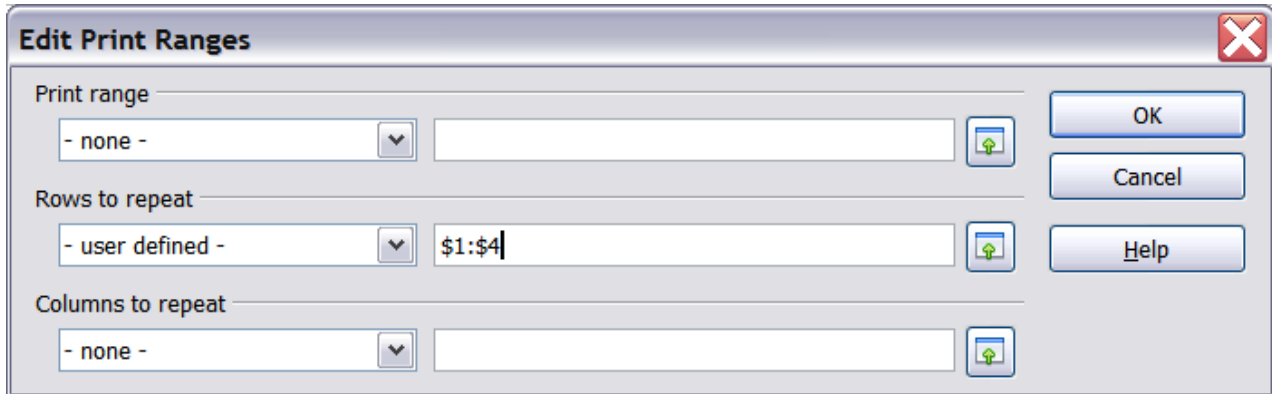

Figure 124: Specifying repeating rows

- 2) To repeat, type the columns in the text entry box under *Columns to repeat*. For example, to repeat column A, type **\$A**. In the *Columns to repeat* list, **- none -** changes to **- user defined -**.
- 3) Click **OK**.

Note

You do not need to select the entire range of the rows to be repeated; selecting one cell in each row works.

Page breaks

While defining a print range can be a powerful tool, it may sometimes be necessary to manually adjust Calc's printout. To do this, you can use a *manual break*. A manual break helps to ensure that your data prints properly. You can insert a horizontal page break above, or a vertical page break to the left of, the active cell.

Inserting a page break

To insert a page break:

- 1) Navigate to the cell where the page break will begin.
- 2) Select **Insert > Manual Break**.
- 3) Select **Row Break** or **Column Break** depending on your need.

The break is now set.

Row break

Selecting *Row Break* creates a page break above the selected cell. For example, if the active cell is H15, then the break is created between rows 14 and 15.

Column break

Selecting *Column Break* creates a page break to the left of the selected cell. For example, if the active cell is H15, then the break is created between columns G and H.

Tip

To see page break lines more easily on screen, you can change their color. Choose **Tools > Options > OpenOffice.org > Appearance** and scroll down to the Spreadsheet section.

Deleting a page break

To remove a page break:

- 1) Navigate to a cell that is next to the break you want to remove.
- 2) Select **Edit > Delete Manual Break**.
- 3) Select **Row Break** or **Column Break** depending on your need.

The break is now removed.

Note

Multiple manual row and column breaks can exist on the same page. When you want to remove them, you have to remove each one individually. This may be confusing at times, because although there may be a column break set on the page, when you go to **Edit > Manual Break**, Column break may be grayed out.

In order to remove the break, you have to be in the cell next to the break. For example, if you set the column break while you are in H15, you can not remove it if you are in cell D15. However, you can remove it from any cell in column H.

Headers and footers

Headers and footers are predefined pieces of text that are printed at the top or bottom of a sheet outside of the sheet area. Headers are set in the same way as footers.

Headers and footers are assigned to a page style. You can define more than one page style for a spreadsheet and assign different page styles to different sheets. For more about page styles, see Chapter 4 (Using Styles and Templates) in the *Calc Guide*.

Setting a header or footer

To set a header or footer:

- 1) Navigate to the sheet that you want to set the header or footer for. Choose **Format > Page**.
- 2) On the Page Style dialog, select the Header (or Footer) tab. See Figure 125.
- 3) Select the **Header on** option.

From here you can also set the margins, the spacing, and height for the header or footer. You can check the **AutoFit height** box to automatically adjust the height of the header or footer.

Margin

Changing the size of the left or right margin adjusts how far the header or footer is from the side of the page.

Spacing

Spacing affects how far above or below the sheet the header or footer will print. So, if spacing is set to 1.00", then there will be 1 inch between the header or footer and the sheet.

Height

Height affects how big the header or footer will be.

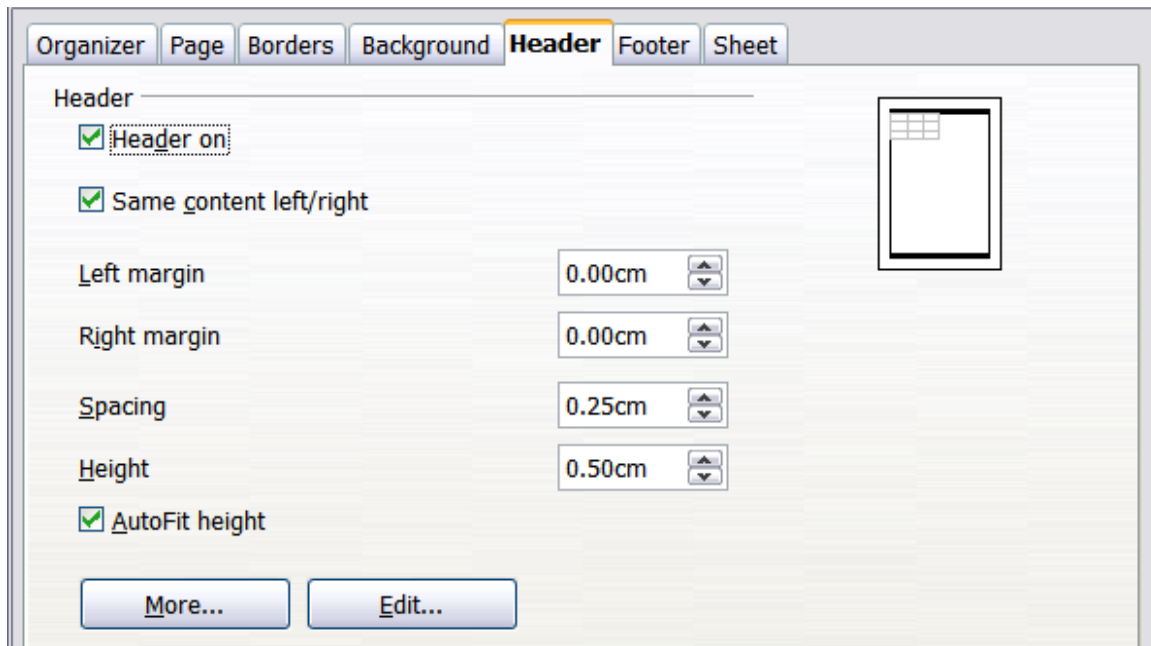

Figure 125: Header dialog

Header or footer appearance

To change the appearance of the header or footer, click the **More** button in the header dialog. This opens the Border/Background dialog (Figure 126).

From this dialog you can set the background and border of the header or footer. For more information see Chapter 4 (Using Styles and Templates) in the *Calc Guide*.

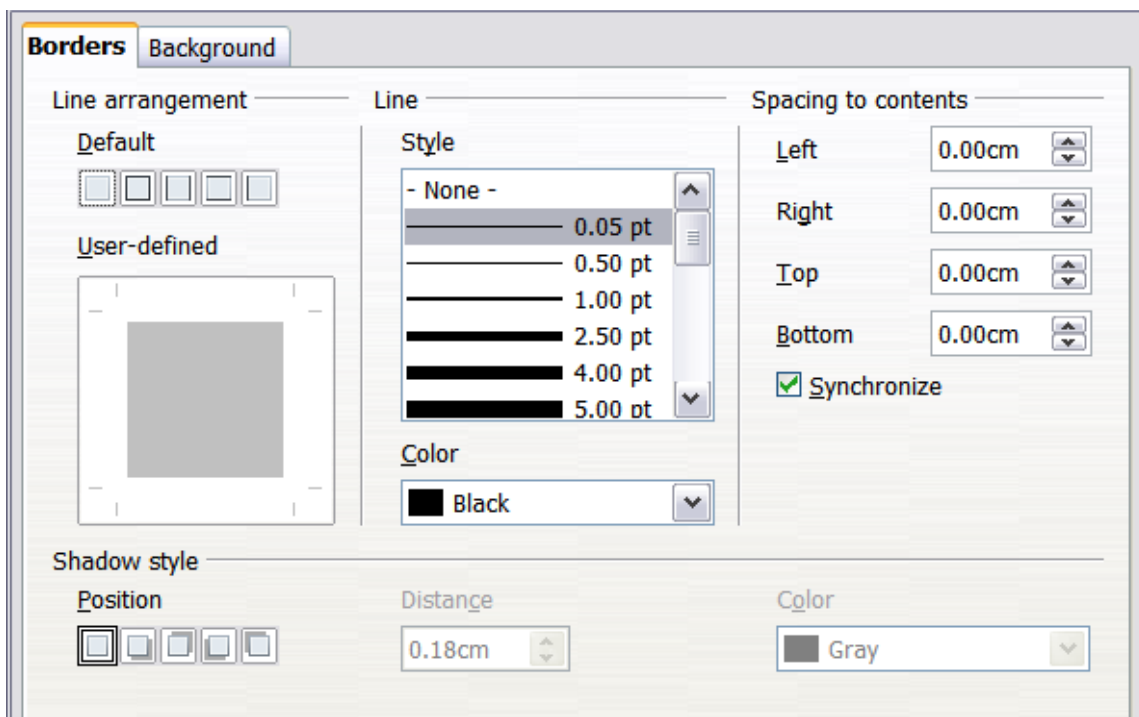

Figure 126: Header/Footer Border/Background

Setting the contents of the header or footer

The header or footer of a Calc spreadsheet has three columns for text. Each column can have different contents.

To set the contents of the header or footer, click the **Edit** button in the header or footer dialog shown in Figure 125 to display the dialog shown in Figure 127.

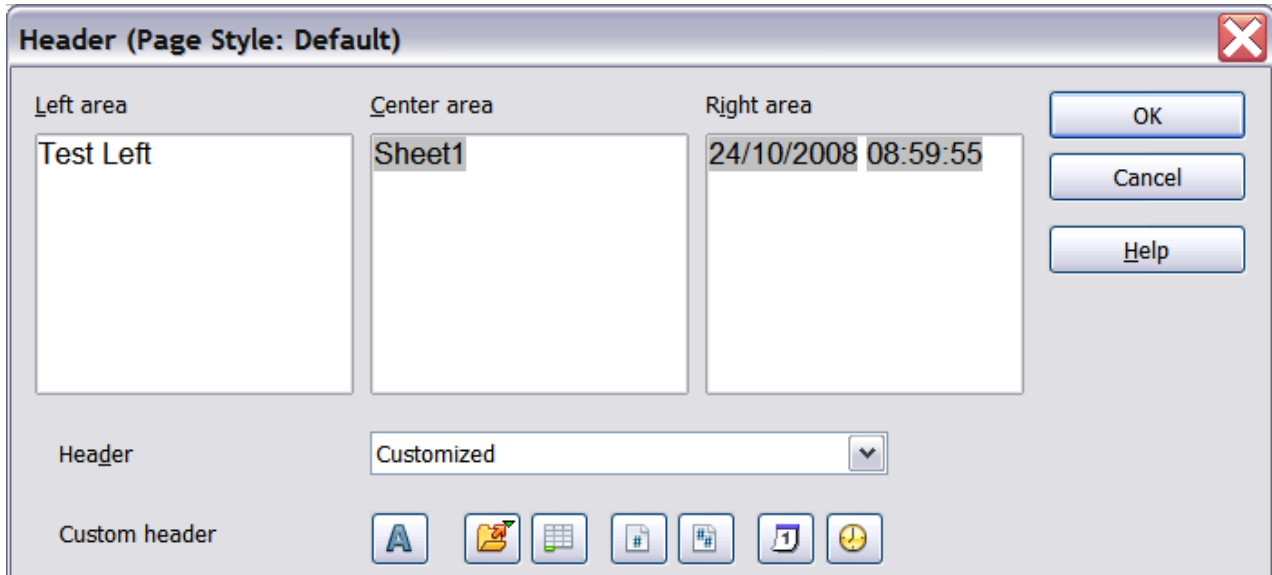

Figure 127: Edit contents of header or footer

Areas







Each area in the header or footer is independent and can have different information in it.

Header

You can select from several preset choices in the Header drop-down list, or specify a custom header using the buttons below the area boxes. (To format a footer, the choices are the same.)

Custom header

Click in the area (Left, Center, Right) that you want to customize, then use the buttons to add elements or change text attributes.

-  Opens the Text Attributes dialog.
-  Inserts the total number of pages.
-  Inserts the File Name field.
-  Inserts the Date field.
-  Inserts the Sheet Name field.
-  Inserts the Time field.
-  Inserts the current page number.

Chapter 6

Getting Started with Impress

Presentations in OpenOffice.org

What is Impress?

Impress is OpenOffice.org's slide show (presentations) program. You can create slides that contain many different elements, including text, bulleted and numbered lists, tables, charts, clip art, and a wide range of graphic objects. Impress also includes a spelling checker, a thesaurus, prepackaged text styles, and attractive background styles.

This chapter includes instructions, screenshots, and hints to guide you through the Impress environment while designing the easier presentations. Although more difficult designs are mentioned throughout this chapter, explanations for creating them are in the *Impress Guide*. If you have a working knowledge of how to create slide shows, we recommend you use the *Impress Guide* for your source of information.

To use Impress for more than very simple slide shows requires some knowledge of the elements which the slides contain. Slides containing text use styles to determine the appearance of that text. Graphic objects are created the same way that drawings are created in Draw. For this reason, we recommend that you also study Chapter 3 (Using Styles and Templates) and Chapter 7 (Getting Started with Draw) in this book. You may also wish to consult the *Draw Guide* for details.

Starting Impress

You can start Impress in several ways:

- From the OOO Start Center, if no component is open.
- From the system menu or the OOO Quickstarter. Details vary with your operating system; see Chapter 1 (Introducing OpenOffice.org) for more information.
- From any open component of OOO. Click the triangle to the right of the **New** icon on the main toolbar and select *Presentation* from the drop-down menu or choose **File > New > Presentation** from the menu bar.

When you start Impress for the first time, the Presentation Wizard is shown. Here you can choose from the following options:

- **Empty presentation**, which gives you a blank document
- **From template**, which is a presentation designed with a template of your choice
- **Open existing presentation**

If you prefer not to use the wizard in future, you can select **Do not show this wizard again**.

Click **Create** to open the main Impress window.

For detailed instructions about how to use the wizard, see "Creating a new presentation" on page 153.

Parts of the main Impress window

The main Impress window (Figure 128) has three parts: the *Slides pane*, *Workspace*, and *Tasks pane*. Additionally, several toolbars can be displayed or hidden during the creation of a presentation.

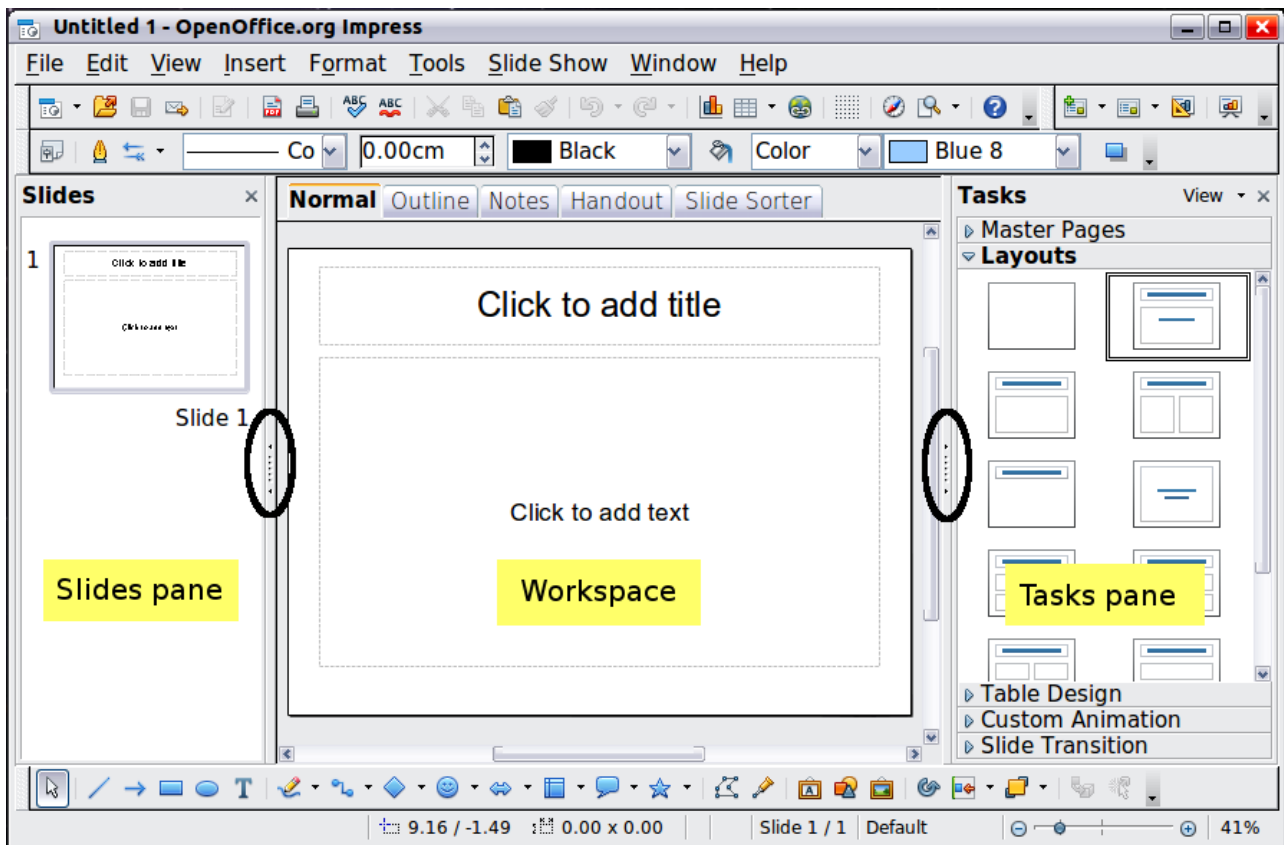

Figure 128: Main window of Impress; oval indicates the Hide/Show markers

Tip

You can remove the *Slides pane* or *Tasks pane* from view by clicking the X in the upper right corner. You can also show or hide these panes using **View > Slide Pane** or **View > Tasks Pane**.

You can also hide these panes in order to maximize the *Workspace* area by clicking the Hide/Show marker in the middle of the vertical separator line and restore them by clicking again on the same area.

Slides pane

The *Slides pane* contains thumbnail pictures of the slides in your presentation, in the order they will be shown (unless you change the slide show order). Clicking a slide in this pane selects it and places it in the *Workspace*. When a slide is in the *Workspace*, you can apply to it any changes desired.

Several additional operations can be performed on one or more slides simultaneously in the *Slides pane*:

- Add new slides to the presentation.
- Mark a slide as hidden so that it will not be shown as part of the presentation.
- Delete a slide from the presentation if it is no longer needed.
- Rename a slide.
- Duplicate a slide (copy and paste) or move it to a different position in the presentation (cut and paste).

It is also possible to perform the following operations, although there are more efficient methods than using the Slides pane:

- Change the slide transition following the selected slide or after each slide in a group of slides.
- Change the sequence of slides in the presentation.
- Change the slide design.
- Change slide layout for a group of slides simultaneously.

Tasks pane

The *Tasks pane* has five sections. To expand the section you wish to use, click on the right-pointing triangle to the left of the caption. Only one section at a time can be expanded.

Master Pages

Here you define the page style for your presentation. Impress contains prepackaged Master Pages (slide masters). One of them—Default—is blank, and the rest have a background.

Tip

Press *F11* to open the Styles and Formatting window, where you can modify the styles used in any slide master to suit your purpose. This can be done at any time.

Layout

The prepackaged layouts are shown here. You can choose the one you want, use it as it is or modify it to your own requirements. At present it is not possible to create custom layouts.

Table Design

The standard table styles are provided in this pane. You can further modify the appearance of a table with the selections to show or hide specific rows and columns, or to apply a banded appearance to the rows and columns.

Custom Animation

A variety of animations for selected elements of a slide are listed. Animation can be added to a slide, and it can also be changed or removed later.

Slide Transition

Many transitions are available, including *No Transition*. You can select the transition speed (slow, medium, fast), choose between an automatic or manual transition, and choose how long the selected slide will be shown.

Workspace

The *Workspace* has five tabs: **Normal**, **Outline**, **Notes**, **Handout**, and **Slide Sorter**. These five tabs are called View buttons. The Workspace below the View buttons changes depending on the chosen view.

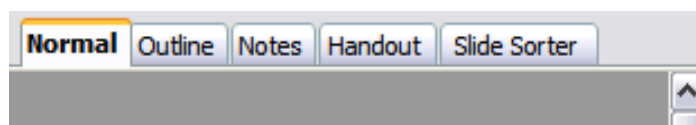

Figure 129: Workspace tabs

Toolbars

Many toolbars can be used during slide creation; they can be displayed or hidden by clicking **View > Toolbars** and selecting from the menu.

You can also select the icons that you wish to appear on each toolbar. For more information, refer to Chapter 1 (Introducing OpenOffice.org) in this book.

Many of the toolbars in Impress are similar to the toolbars in Draw. Refer to the *Draw Guide* for details on the functions available and how to use them.

Status bar

The *Status bar*, located at the bottom of the Impress window, contains information that you may find useful when working on a presentation. For details on the contents and use of these fields, see Chapter 1 (Introducing OpenOffice.org) in this book and Chapter 1 (Introducing Impress) in the *Impress Guide*.

Note

The sizes are given in the current measurement unit (not to be confused with the ruler units). This unit is defined in **Tools > Options > OpenOffice.org Draw > General**, where you can also change the scale of the page. Another way to change the scale is to double-click on the number shown in the status bar.

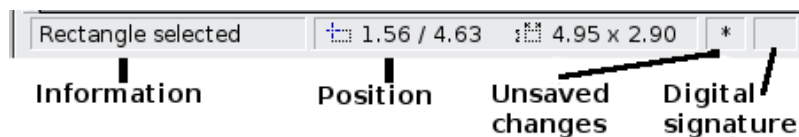

Figure 130: Left end of the Impress status bar

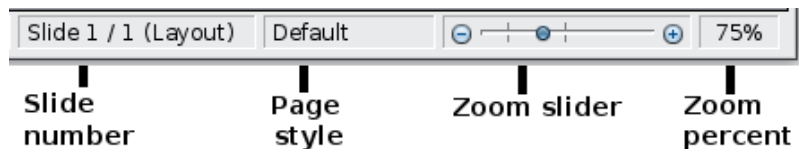



Figure 131: Right end of Impress status bar

Navigator

The Navigator displays all objects contained in a document. It provides another convenient way to move around a document and find items in it. To

display the Navigator, click its icon  on the Standard toolbar, choose **View > Navigator** on the menu bar, or press *Ctrl+Shift+F5*.

The Navigator is more useful if you give your slides and objects (pictures, spreadsheets, and so on) meaningful names, instead of leaving them as the default “Object 1” and “Shape 1” shown in Figure 132.

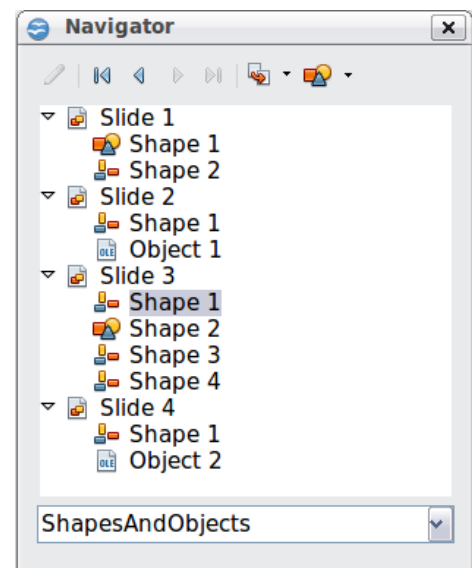

Figure 132: Navigator

Workspace views

Each of the workspace views is designed to ease the completion of certain tasks; it is therefore useful to familiarize yourself with them in order to quickly accomplish those tasks.

Normal view

Normal view is the main view for working with individual slides. Use this view to format and design and to add text, graphics, and animation effects.

To place a slide in the slide design area (Normal view), click the slide thumbnail in the Slides pane or double-click it in the Navigator.

Outline view

Outline view contains all the slides of the presentation in their numbered sequence. It shows topic titles, bulleted lists, and numbered lists for each slide in outline format. Only the text contained in the default text boxes in each slide is shown, so if your slide includes other text boxes or drawing objects, the text in these objects is not displayed. Slide names are also not included.

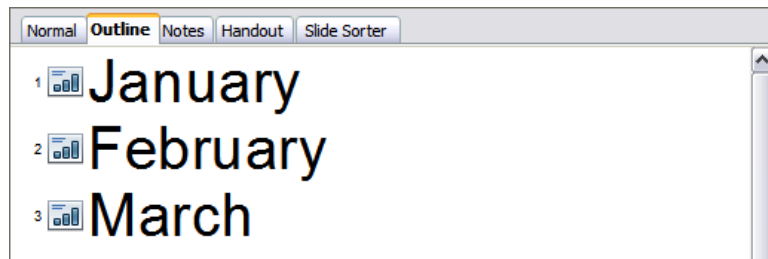
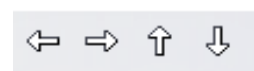

Figure 133: Outline view

Use Outline view for the following purposes.

- 1) Making changes in the text of a slide:
 - Add and delete the text in a slide just as in the Normal view.
 - Move the paragraphs of text in the selected slide up or down by using the up and down arrow buttons (Move Up or Move Down) on the Text Formatting toolbar.
 - Change the outline level for any of the paragraphs in a slide using the left and right arrow buttons (Promote or Demote).
 - Both move a paragraph and change its outline level using a combination of these four arrow buttons.
- 2) Comparing the slides with your outline (if you have prepared one in advance). If you notice from your outline that another slide is needed, you can create it directly in the Outline view or you can return to the Normal view to create it.



Notes view

Use the *Notes view* to add notes to a slide.

- 1) Click the **Notes** tab in the Workspace.
- 2) Select the slide to which you want to add notes.
 - Click the slide in the Slides pane, or

- Double-click the slide's name in the Navigator.
- 3) In the text box below the slide, click on the words *Click to add notes* and begin typing.

You can resize the Notes text box using the green resizing handles which appear when you click on the edge of the box. You can also move the box by placing the pointer on the border, then clicking and dragging. To make changes in the text style, press the *F11* key to open the Styles and Formatting window.

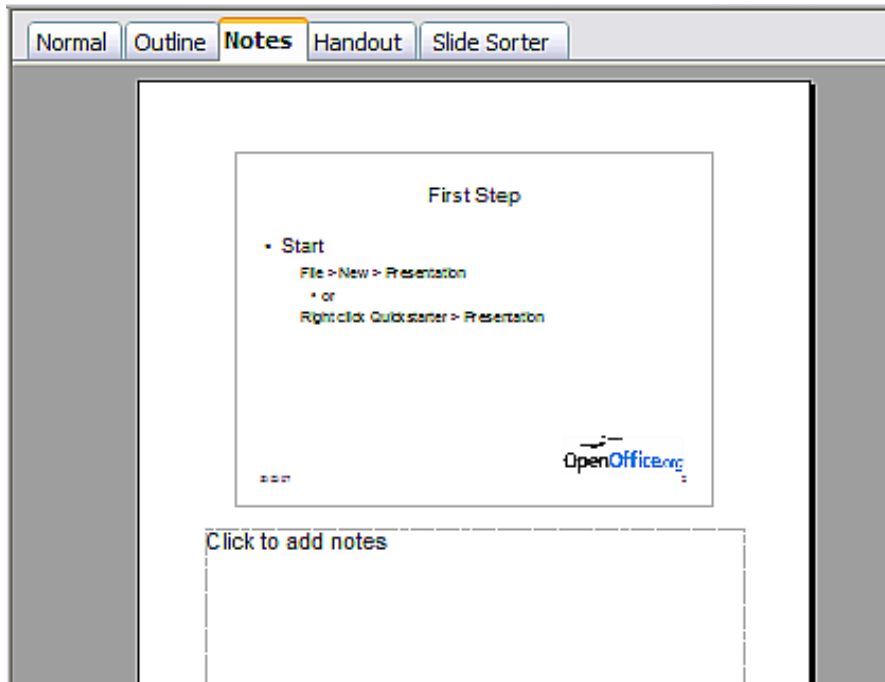

Figure 134: Notes view

Handout view

Handout view is for setting up the layout of your slide for a printed handout. Click the *Handout* tab in the workspace, then choose **Layouts** in the Tasks pane. You can then choose to print 1, 2, 3, 4, 6, or 9 slides per page.

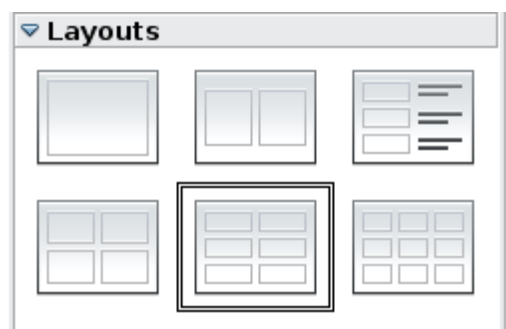

Figure 135: Handout layouts

Use this view also to customize the information printed on the handout. Refer to Chapter 10 of the *Impress Guide* for instructions on printing slides, handouts, and notes.

Select from the main menu **Insert > Page Number** or **Insert > Date and Time** and in the dialog box that opens click on the Notes and Handouts tab (see Figure 136).

Use this dialog to select the elements you want to appear on each handout page and their contents. More details on how to use this dialog are provided in the *Impress Guide*.

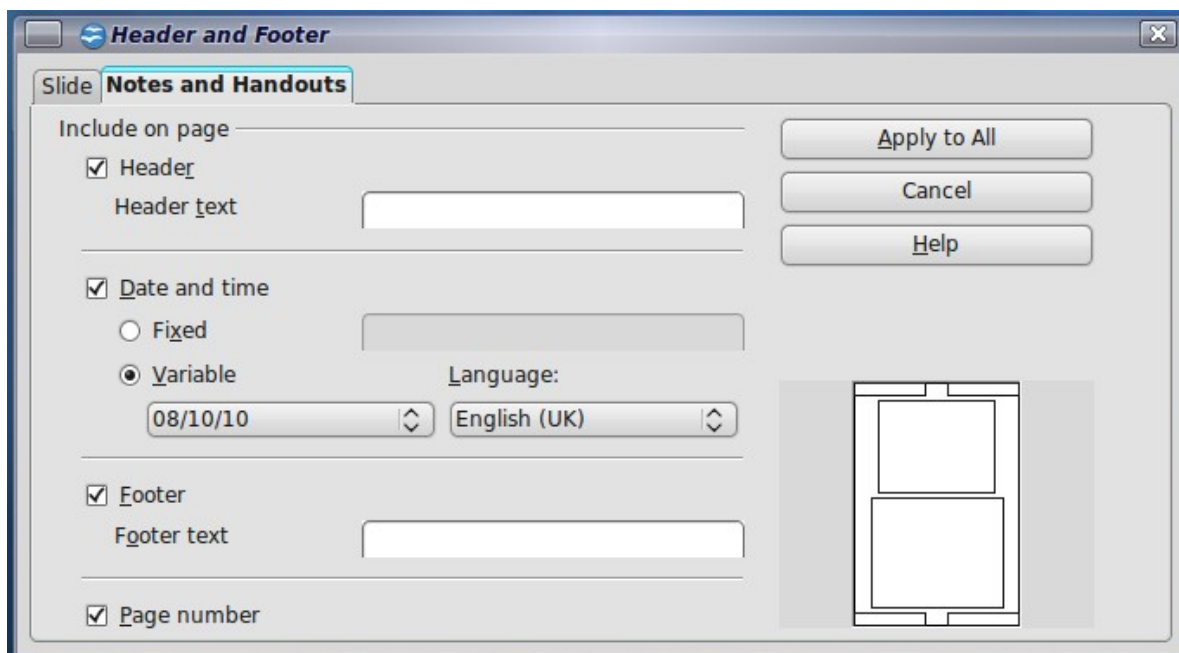

Figure 136: Dialog to set the page information for handouts and notes

Slide Sorter view

Slide Sorter view contains all of the slide thumbnails. Use this view to work with a group of slides or with only one slide.

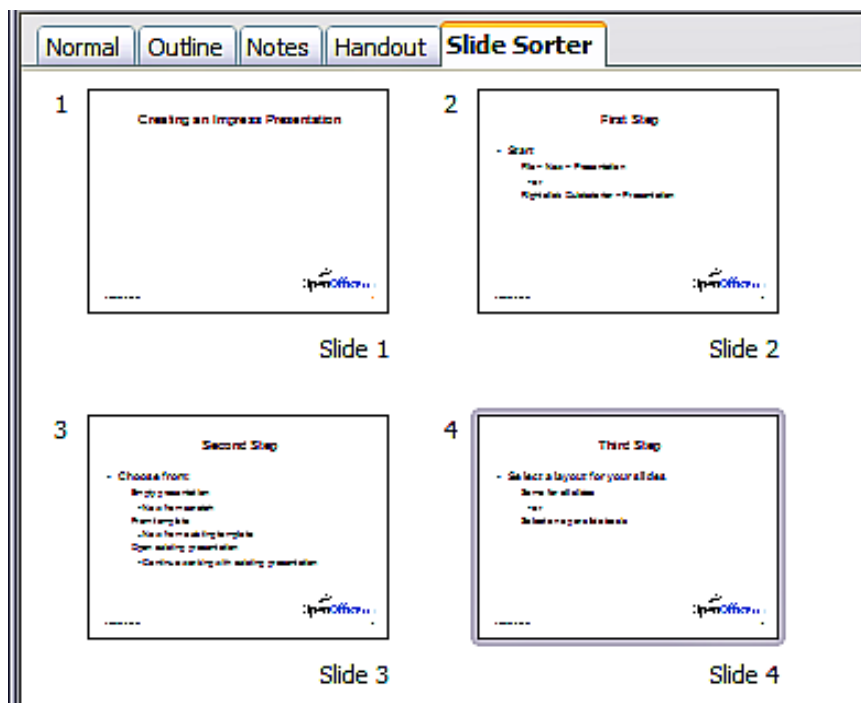

Figure 137: Slide Sorter view

Customizing Slide Sorter view

To change the number of slides per row:

- 1) Check **View > Toolbars > Slide View** to make the Slide View toolbar visible.



Figure 138: Slide Sorter and Slide View toolbars

- 2) Adjust the number of slides (up to a maximum of 15).

Moving a slide using Slide Sorter

To move a slide in a presentation in the Slide Sorter:

- 1) Click the slide. A thick black border is drawn around it.
- 2) Drag and drop it to the location you want.
 - As you move the slide, a black vertical line appears to one side of the slide.
 - Drag the slide until this black vertical line is located where you want the slide to be moved.

Selecting and moving groups of slides

To select a group of slides, use one of these methods:

- Use the *Control (Ctrl)* key: Click on the first slide and, while keeping the Control key pressed, select the other desired slides.
- Use the *Shift* key: Click on the first slide, and while pressing the *Shift* key, click on the final slide in the group. This selects all of the other slides in between the first and the last.
- Use the mouse: Click slightly to the left of the first slide to be selected. Hold down the left mouse button and drag the mouse pointer to a spot slightly to the right of the last slide to be included. (You can also do this right to left.) A dashed outline of a rectangle forms as you drag the cursor through the slide thumbnails and a thick border is drawn around each of the selected slides. Make sure the rectangle includes all the slides you want to select.

To move a group of slides:

- 1) Select the group.
- 2) Drag and drop the group to their new location. A vertical black line appears to show you where the group of slides will go.

Working in Slide Sorter view

You can work with slides in the Slide Sorter view just as you can in the Slide pane.

To make changes, right-click a slide and choose any of the following from the pop-up menu:

- Add a new slide after the selected slide.
- Rename or delete the selected slide.
- Change the slide layout.
- Change the slide transition.
 - For one slide, click the slide to select it. Then add the desired transition.

- For more than one slide, select the group of slides and add the desired transition.
- Mark a slide as hidden. Hidden slides will not be shown in the slide show.
- Copy or cut and paste a slide.

Renaming slides

Right-click on a thumbnail in the Slides pane or the Slide Sorter and choose **Rename Slide** from the pop-up menu. In the *Name* field, delete the old name of the slide and type the new name. Click **OK**.

Creating a new presentation

This section describes how to start a new presentation using the Presentation Wizard. When you start Impress, the Presentation Wizard appears.

Tip

If you do not want the wizard to start every time you launch Impress, select the **Do not show this wizard again** option. You can enable the wizard again later under **Tools > Options > OpenOffice.org Impress > General > Wizard**, and select the **Start with wizard** option.

Leave the **Preview** option selected, so templates, slide designs, and slide transitions appear in the preview box as you choose them.

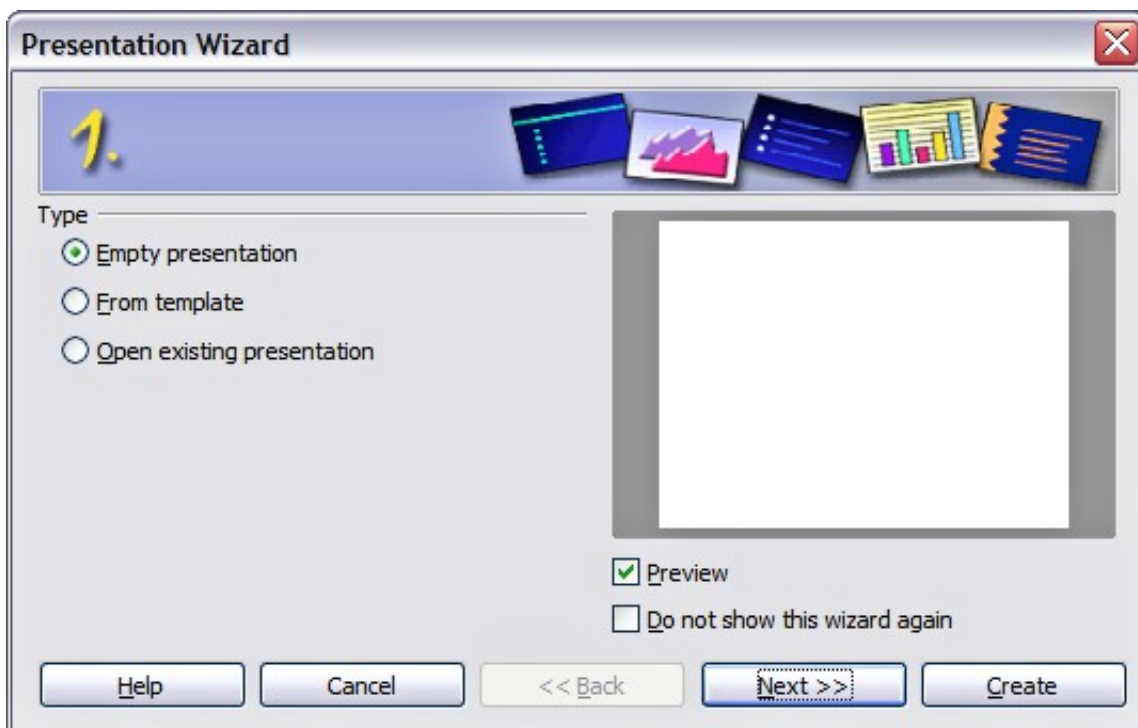

Figure 139: Choosing the type of presentation

- 1) Select *Empty Presentation* under **Type**. It creates a presentation from scratch.
 - *From template* uses a template design already created as the basis for a new presentation. The wizard changes to show a list of available templates. Choose the template you want.

- *Open existing presentation* continues work on a previously created presentation. The wizard changes to show a list of existing presentations. Choose the presentation you want.

Both of these options are covered in the *Impress Guide*.

- 2) Click **Next**. Figure 140 shows the Presentation Wizard step 2 as it appears if you selected *Empty Presentation* at step 1. If you selected *From template*, an example slide is shown in the Preview box.

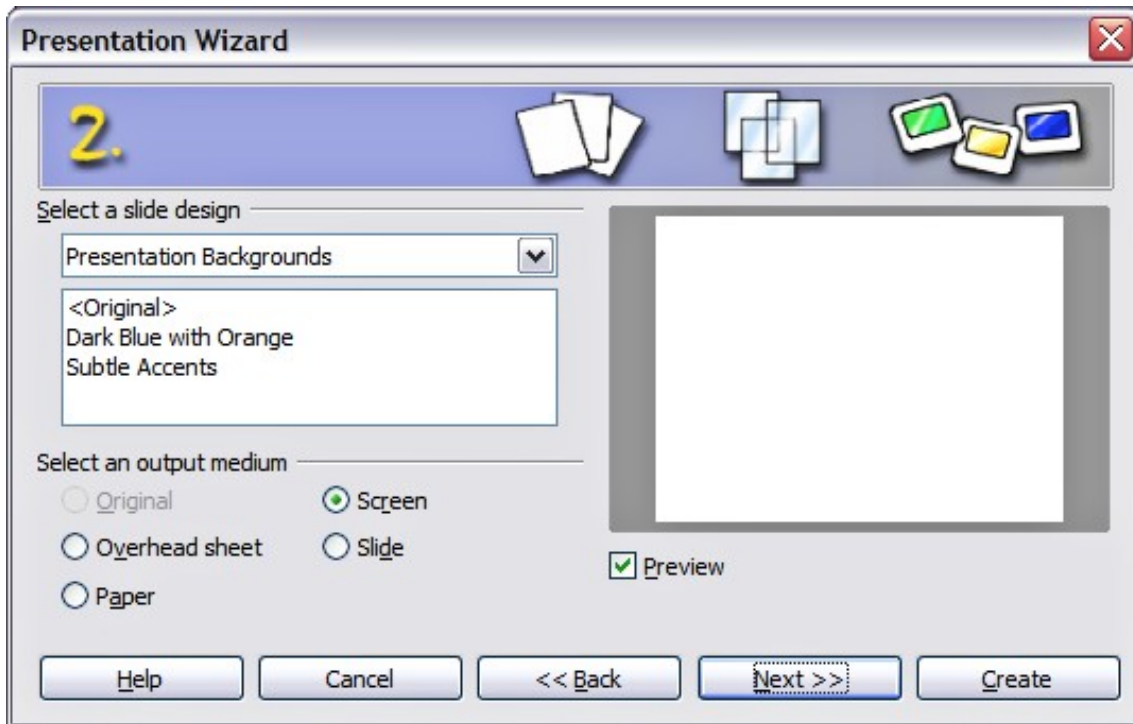

Figure 140: Selecting a slide design

- 3) Choose a design under **Select a slide design**. The slide design section gives you two main choices: *Presentation Backgrounds* and *Presentations*. Each one has a list of choices for slide designs. If you want to use one of these other than *<Original>*, click it to select it.
 - The types of *Presentation Backgrounds* are shown in Figure 140. By clicking an item, you will see a preview of the slide design in the Preview window. Impress contains three choices under *Presentations*: *<Original>*, *Introducing a New Product*, and *Recommendation of a Strategy*.
 - *<Original>* is for a blank presentation slide design.
 - Both *Introducing a New Product* and *Recommendation of a Strategy* have their own prepackaged slide designs. Each design appears in the Preview window when its name is clicked.

Note

Introducing a New Product and *Recommendation of a Strategy* can also be used to create a presentation by choosing **From template** in the first step (Figure 139).

- 4) Select how the presentation will be used under **Select an output medium**. Most often, presentations are created for computer screen display. Select *Screen*. You can change the page format at any time.

Note The Screen page is optimized for a 4:3 display (28cm x 21cm) so it is not suitable for modern widescreen displays. You can change the slide size at any time switching to Normal view and selecting **Format > Page**.

5) Click **Next**. The **Presentation Wizard** step 3 appears.

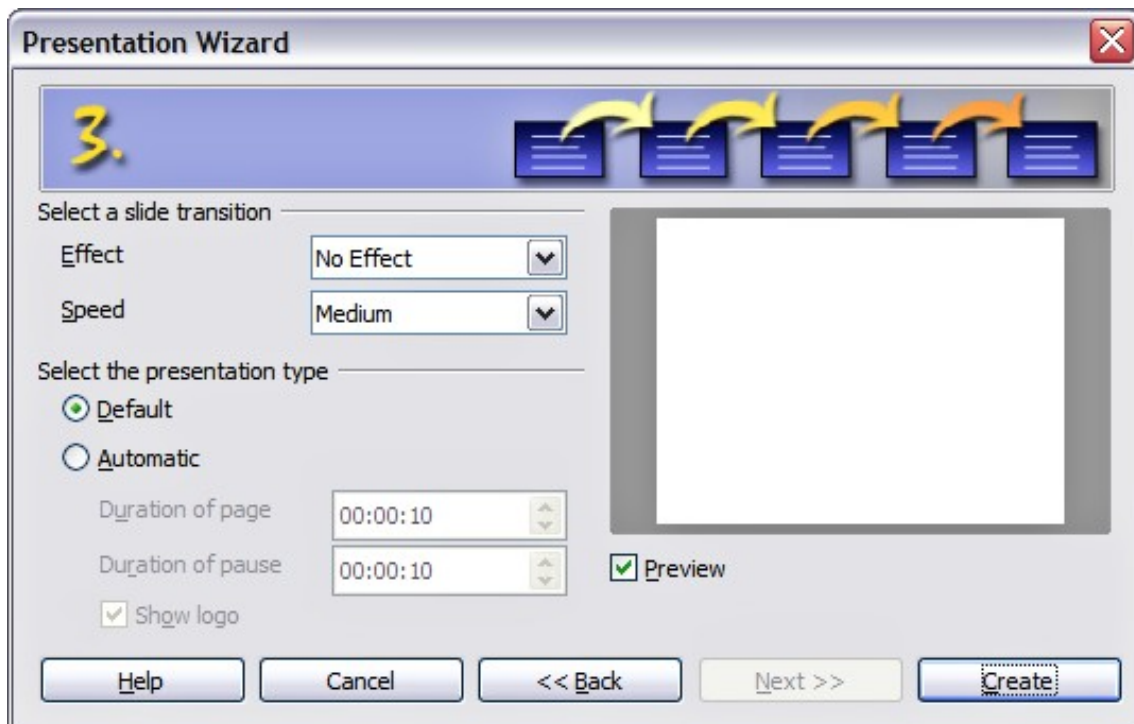

Figure 141: Selecting a slide design

- Choose the desired slide transition from the *Effect* drop-down menu.
- Select the desired speed for the transition between the different slides in the presentation from the **Speed** drop-down menu. *Medium* is a good choice for now.

6) Click **Create**. A new presentation is created.

Tip You might want to accept the default values for both *Effect* and *Speed* unless you are skilled at doing this. Both of these values can be changed later while working with **Slide transitions** and **animations**. These two features are explained in more detail in Chapter 9 of the *Impress Guide*.

Note If you selected *From template* on step 1 of the Wizard, the **Next** button will be active on step 3 and other pages will be available. These pages are not described here.

Caution



Remember to save frequently while working on the presentation, to prevent any loss of information should something unexpected occur. You might also want to activate the AutoRecovery function (**Tools > Options > Load/Save > General**). Make sure **Save AutoRecovery information every** is selected and that you have entered a recovery frequency.

Formatting a presentation

A new presentation contains only one empty slide. In this section we will start adding new slides and preparing them for the intended contents.

Inserting slides

This can be done in a variety of ways; take your pick.

- **Insert > Slide.**
- Right-click on the present slide, and select **Slide > New Slide** from the pop-up menu.
- Click the **Slide** icon in the *Presentation* toolbar.



Sometimes, rather than starting from a new slide you want to duplicate a slide you have already inserted. To do so select the slide you want to duplicate from the Slides pane and then choose **Insert > Duplicate Slide**.

Selecting a layout

In the Tasks pane, select the Layout drawer to display the available layouts. The Layouts differ in the number of elements a slide will contain, spanning from the empty slide (Blank Slide) to a slide with 6 contents boxes and a title (Title, 6 contents).

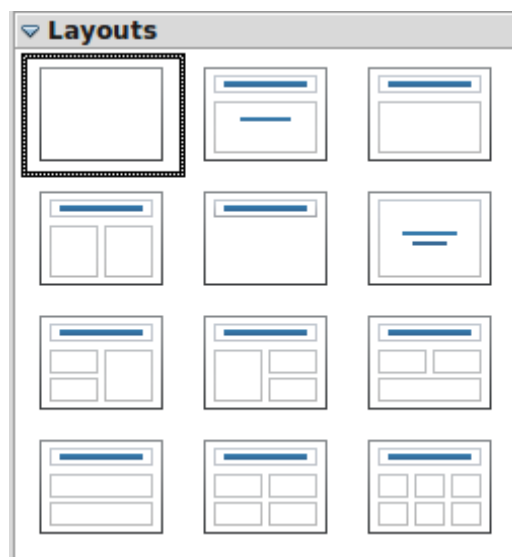

Figure 142: Available slide layouts

Note

Text and graphic elements can be readjusted at any time during the preparation of the presentation, but changing the layout of a slide that already contains some contents can have a dramatic effect. It is therefore recommended that you pay particular attention to the layout you select. If you do need to change the layout after contents have been added, the contents are not lost though they may need to be reformatted.

The *Title Slide* (which also contains a section for a subtitle) or *Title Only* are suitable layouts for the first slide, while for most of the slides you will probably use the *Title, Contents* layout.

Tip

If you do not know the names for the prepackaged layouts position the cursor on an icon in the Layout section and its name will be displayed in a small rectangle.

The small rectangle is called tooltip. If the tooltips are not enabled select **Tools > Options > OpenOffice.org > General > Help** and mark the **Tips** checkbox. If the **Extended tips** checkbox is also marked, you will get more detailed tooltip information, but the tooltip names themselves will not be provided.

Several layouts contain one or more content boxes. Each of these boxes can be configured to contain one of the following elements: Text, Media clip, Picture, Chart or Table.

You can choose the type of contents by clicking on the corresponding icon that is displayed in the middle of the contents box as shown in Figure 143. If instead you intend to use the contents box for text, just click anywhere on the box to get a cursor.

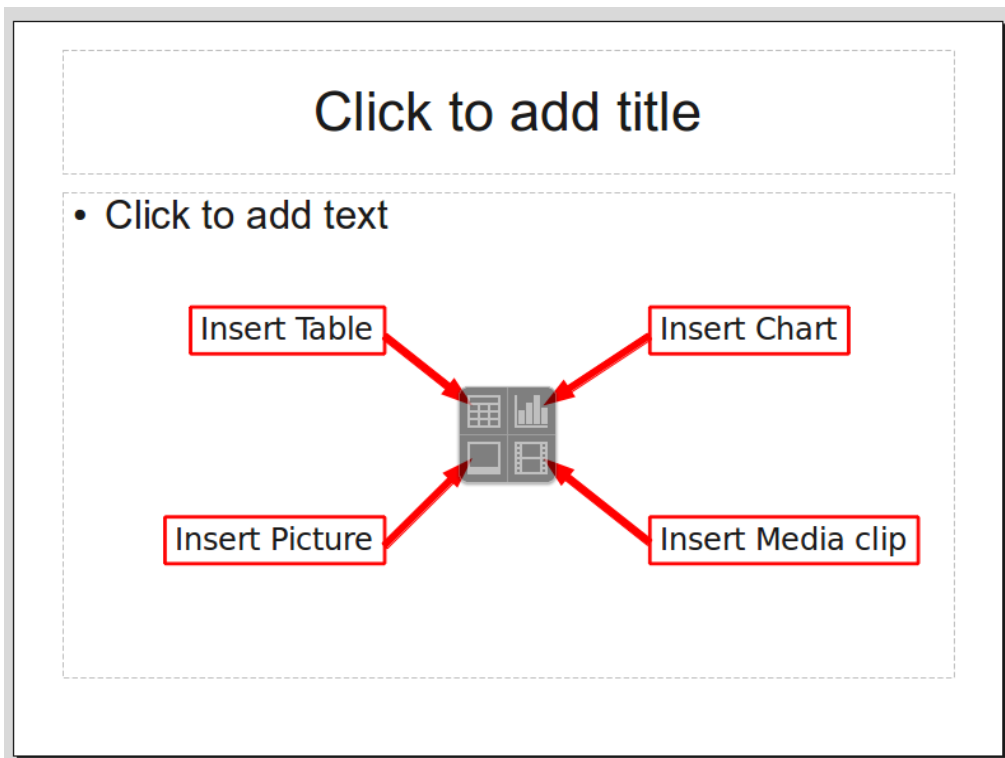

Figure 143: Selecting the desired contents type for a contents box

To select or change the layout, place the slide in the work area and select the desired layout from the layout drawer in the Task Pane.

If you have selected a layout with one or more contents boxes, this is a good time to decide what type of contents you want to insert.

Modifying the slide elements

At present each slide will contain only the elements that are present in the slide master you are using such as background images, logos, header, footer and so on. It is however unlikely that the predefined layouts will suit all your needs. Although Impress does not have the functionality to create new layouts, it allows you to resize and move the layout elements. It is also possible to add slide elements without being limited to the size and position of the layout boxes.

To resize a contents box, click on the outer frame so that the 8 resizing handles are displayed. To move it place the mouse cursor on the frame so that the cursor changes shape. You can now click the left mouse button and drag the contents box to its new position on the slide.

Caution



Changes to any of the pre-packaged layouts can only be made using **View > Normal**, which is the default. Attempting to do this by modifying a slide master, although possible, may result in unpredictable results and requires extra care as well as a certain amount of trial and error.

At this step you may also want to remove unwanted frames. To do this:

- Click the element to highlight it. (The green squares show it is highlighted.)
- Press the *Delete* key to remove it.

Adding text to a slide

If the slide contains text, click on *Click to add an outline* in the text frame and then type your text. The Outline styles from 1 to 10 are automatically applied to the text as you insert it. You can change the outline level of each paragraph as well as its position within the text using the arrow buttons on the *Text Formatting* toolbar. See “Adding and formatting text” on page 159 for more information.

Modifying the appearance of all slides

To change the background and other characteristics of all slides in the presentation, it is best to modify the slide master or choose a different slide master as explained in the section Working with slide masters and styles on page 166.

If all you need to do is to change the background, you can take a shortcut:

- 1) Select **Format > Page** and go to the Background tab.
- 2) Select the desired background between solid color, gradient, hatching and bitmap.
- 3) Click **OK** to apply it.

A dialog box will open asking if the background should be applied to all the slides. If you click yes, Impress will automatically modify the slide master for you.

Note

Inserting and correctly formatting a background is beyond the scope of this chapter, but you can find all the information you need in Chapter 4 of the *Draw Guide* or in Chapter 6 of the *Impress Guide*.

Modifying the slide show

By default the slide show will display all the slides in the same order as they appear in the slide sorter, without any transition between slides, and you need some keyboard or mouse interaction to move from one slide to the next.

You can use the Slide Show menu to change the order of the slides, choose which ones are shown, automate moving from one slide to the next, and other settings. To change the slide transition, animate slides, add a soundtrack to the presentation, and make other enhancements, you need to use functions in the Task pane. See the *Impress Guide* for details on how to use all of these features.

Adding and formatting text

Many of your slides are likely to contain some text. This section gives you some guidelines on how to add text and how to change its appearance. Text in slides is contained in *text boxes*.

There are two types of text boxes that you can add to a slide:

- Choose a predefined layout from the *Layouts* section of the Tasks pane and do not select any special contents type. These text boxes are called **AutoLayout** text boxes.
- Create a text box using the text tool in the Drawing toolbar.

Using text boxes created from the Layout pane

In Normal view:

- 1) Click in the text box that reads **Click to add text**, **Click to add an outline**, or a similar notation.
- 2) Type or paste your text in the text box.

Using text boxes created from the text box tool

In Normal view:

- 1) Click on the **Text** icon  on the Drawing toolbar. If the toolbar with the text icon is not visible, choose **View > Toolbars > Drawing**.
- 2) Click and drag to draw a box for the text on the slide. Do not worry about the vertical size and position—the text box will expand if needed as you type.
- 3) Release the mouse button when finished. The cursor appears in the text box, which is now in edit mode (gray hashed border with green resizing handles shown in Figure 144).
- 4) Type or paste your text in the text box.
- 5) Click outside the text box to deselect it.

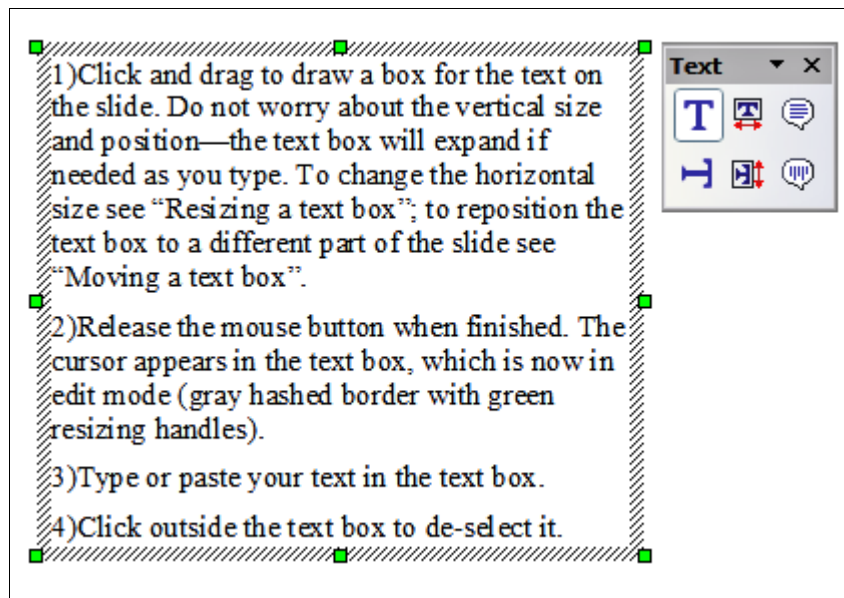



Figure 144: Selected text box showing the green resizing handles and text toolbar

You can move, resize, and delete text boxes. For more information, see Chapter 3 in the *Impress Guide*.

Note

In addition to the normal text boxes where text is horizontally aligned, it is possible to insert text boxes where the text is aligned vertically. This choice is available only when Asian languages are enabled in **Tools > Options > Language Settings > Languages**.

Click on the  button in the drawing toolbar to create a vertical text box. Note that when editing the contents, the text is displayed horizontally.

Quick font resizing

Starting with OOo3.1, Impress has convenient buttons on the Formatting toolbar to increase or decrease font size of selected text. The amount by which the font size changes depends on the standard sizes available for the font in use.

Pasting text

You can insert text into a text box by copying it from another document and pasting it into Impress. However, the pasted text will probably not match the formatting of the surrounding text or that of the other slides in the presentation. This may be what you want on some occasions; however in most cases you want to make sure that the presentation does not become a patchwork of different paragraph styles, font types, bullet points and so on. There are several ways to ensure consistency; these methods are explained below.

Pasting unformatted text

It is normally good practice to paste text without formatting and apply the formatting later. To paste without formatting, either press *Control+Shift+V* and then select **Unformatted text** from the dialog that appears, or click on the small black triangle

next to the paste symbol in the standard toolbar  and select **Unformatted text**. The unformatted text will be formatted with the outline style at the cursor position in an AutoLayout text box or with the default graphic style in a normal text box.

Formatting pasted text

If you are pasting the text into an **AutoLayout** area, you need to apply the appropriate *outline style* to the text to give it the same look and feel as the rest of the presentation.

- 1) Paste the text in the desired position. Do not worry if it does not look right; it will in a minute.
- 2) Select the text you have just pasted.
- 3) Select **Format > Default formatting** from the menu bar.
- 4) Use the four arrow buttons in the Text Formatting toolbar  to move the text to the appropriate position and give it the appropriate outline level. The button with the arrow pointing left promotes the list entry by one level (for example from Outline 3 to Outline 2), the right arrow button demotes the list entry by one level, the up and down arrow buttons move the list entry.
- 5) Apply manual formatting as required to sections of the text (to change font attributes, tabs, and so on).

If you are pasting text in a **text box**, you can still use styles to quickly format the text. Note that one *and only one* graphic style can be applied to the copied text. To do that:

- 1) Paste the text in the desired position.
- 2) Select the text you have just pasted.
- 3) Select the desired graphic style.
- 4) Apply manual formatting as required to sections of the text.

Tip

Presentation styles are very different from Writer styles and are applied in quite a different way.

Creating bulleted and numbered lists

The procedure to create a bulleted or numbered list is quite different depending on the type of text box used, although the tools to manage the list and customize the appearance are the same.

In text boxes created automatically by Impress (called AutoLayout), the outline styles available are by default bulleted lists, while for normal text boxes an additional step is required to create a bulleted list.

Creating lists in AutoLayout text boxes

Every text box included in the available layouts is already formatted as a bulleted list, therefore to create a bulleted list the only necessary steps are:

- 1) From the Layout pane, choose a slide design that contains a text box. Those are easily recognizable from the thumbnail.
- 2) Click in the text box that reads **Click to add an outline**.
- 3) Type the text, then press *Enter* to start a new bulleted line.

The methods for switching between bulleted and numbered lists are explained in “Changing the appearance of the list” on page 162.

Tip

Press *Shift + Enter* to start a new line without creating a new bullet or number. The new line will have the same indentation of the previous line. To switch off bullets altogether, click the bullets button  on the text formatting toolbar. If the text formatting toolbar is not showing, enable it selecting **View > Toolbar > Formatting** in the menu bar.

Creating lists in other text boxes

To create a list in a text box, follow these steps:

- 1) Place the cursor in the text box.
- 2) Click the **Bullets On/Off** button  on the text formatting toolbar. If the text formatting toolbar is not showing, enable it by selecting **View > Toolbar > Formatting** from the menu bar.
- 3) Type the text and press *Enter* to start a new bulleted line.
- 4) The default list type is a bulleted list. Methods for changing the appearance of the list are explained on page 162.

Creating a new outline level

- 1) If necessary, press *Enter* to begin a new line.
- 2) Press *Tab*. Each time you press *Tab* the line indents to the next outline level. Pressing *Enter* creates a new line at the same level as the previous one. To return to the previous level, press *Shift+Tab*.

In the AutoLayout text boxes, promoting or demoting an item in the list corresponds to applying a different outline style, so the second outline level corresponds to Outline 2 style, the third to Outline 3 style, and so on.

Note

Do not try to change the outline level by selecting the text and then clicking the desired outline style as you would in Writer. Due to the way that presentation styles work, it is not possible to apply them in this way.

Changing the appearance of the list

You can fully customize the appearance of a list, changing the bullet type or numbering for the entire list or for single entry. All of the changes can be made using the Bullets and Numbering dialog, which is accessed by selecting **Format > Bullets and Numbering** or by clicking on the **Bullets and Numbering** icon on the text formatting toolbar.

For the entire list:

- 1) Select the entire list or click on the gray border of the text box so that the green resizing handles are displayed.
- 2) Select **Format > Bullets and Numbering** or click on the **Bullets and Numbering** icon  .
- 3) The Bullets and Numbering dialog contains five tabs: Bullets, Numbering type, Graphics, Position, and Customize.
 - If a bullet list is needed, select the desired bullet style from the default styles available on the *Bullets* page.
 - If a graphics style is needed, select one from those available on the *Graphics* page.
 - If a numbered list is needed, select one of the default numbering styles on the *Numbering type* page.

For a single line in the list:

- 1) Click anywhere in the line to place the cursor in it.
- 2) Follow steps 2-4 of the previous instruction set.

If the list was created in an AutoLayout text box, then an alternative way to change the entire list is to modify the Outline styles. Changes made to the outline style will apply to all the slides using them. Sometimes this is what you want; sometimes it is not, so some care must be taken.

Adding pictures, tables, charts and media

As we have seen, besides text a contents box can contain also pictures, tables, charts or media clips. This section provides a quick overview of how to work with these objects, however for a more detailed description you are invited to consult the *Impress Guide*.

Adding pictures

To add a picture to a contents box:

- Click the Insert Picture icon. 
- Use the file browser to select the picture file you want to include. To see a preview of the picture, check **Preview** at the bottom of the Insert picture dialog.
- Click **Open**.

The picture will resize itself to fill the area of the contents box. Follow the directions in the Caution note below when resizing it by hand.

Note

You can easily add a picture to a slide outside a contents box. Just select from the main menu **Insert > Picture > From File** and follow the same procedure as above. You will also probably need to move the picture to the desired location.

Caution

When resizing a graphic, right-click the picture. Select **Position and Size** from the context menu and make sure that **Keep ratio** is selected. Then adjust the height or width to the size you need. (As you adjust one dimension, both dimensions will change.) Failure to do so will cause the picture to become distorted. Remember also that resizing a bitmap image will reduce its quality; better by far to create an image of the desired size outside of Impress.

Adding tables

For displaying tabular data, you can insert basic tables directly into your slides by choosing the Table contents type. It is also possible to add a table outside a contents box in a number of ways:

- Choose **Insert > Table** from the menu bar
- With the Table button on the main toolbar 
- With the *Table Design* button on the table toolbar
- Select a Style option from the Table Design section of the Tasks pane.

Each method opens the Insert Table dialog. Alternatively, clicking on the black arrow next to the Table button displays a graphic that you can drag and select the number of rows and columns for your table.



Figure 145: Creating a table with the Insert Table dialog

Note

Selecting from any of the styles in the Table Design section of the Tasks pane creates a table based on that style. If you create a table by another method, you can still apply a style of your choice later.

With the table selected, the Table toolbar should appear. If it does not, you can access it by selecting **View > Toolbars > Table**. The Table toolbar offers many of the same buttons as the table toolbar in Writer, with the exception of functions like Sort and Sum for performing calculations. For those functions, you need to use a spreadsheet inserted from Calc (discussed below).

After the table is created, you can modify it in much the same ways as you would modify a table in Writer: adding and deleting rows and columns, adjusting width and spacing, adding borders, background colors and so on. Detailed information on working with tables and the Table Properties dialog can be found in Chapter 9 of the *Writer Guide*.

By modifying the style of the table from the Table Design section of the Tasks pane, you can quickly change the appearance of the table or any newly created tables based on the Style options you select. You can choose to add emphasis to a header

and total row as well as the first and last columns of the table, and apply a banded appearance to the rows and columns.

Having completed the table design, entering data into the cells is similar to working with text box objects. Click in the cell you wish to add data to, and begin typing. To move around cells quickly, use the following key options:

- The *arrow keys* move the cursor to the next table cell if the cell is empty, otherwise they move the cursor to the next character in the cell.
- The *Tab* key moves to the next cell, skipping over the contents of the cell; *Shift+Tab* move backwards in this manner.

Adding charts

To insert a chart in a slide you can either use the **Insert Chart** feature or select Chart as type for one of the contents box. In both cases Impress will insert a default chart. To modify the chart type, insert your own data and change the formatting refer to the *Impress Guide*.

Adding media clips

You can insert various types of music and movie clips into your slide by selecting the **Insert Movie** button in an empty contents box. A media player will open at the bottom of the screen and you can preview the media. In case of an audio file, the contents box will be filled with a loudspeaker image.

Caution



In Linux-based systems such as Ubuntu, media do not work straight out of the box. You need to download the Java Media Framework API (JMF) and add the path to `jmf.jar` to the Class Path in **Tools > Options > OpenOffice.org > Java**.

Adding graphics, spreadsheets, and other objects

Graphics such as shapes, callouts, arrows, and so on are often useful to complement the text on a slide. These objects are handled much the same as graphics in Draw. For more information, see Chapter 7 (Getting Started with Draw), the *Draw Guide*, or Chapters 4, 5, and 6 in the *Impress Guide*.

Spreadsheets embedded in Impress include most of the functionality of spreadsheets in Calc and are therefore capable of performing extremely complex calculations and data analysis. If you need to analyze your data or apply formulas, these operations are best performed in a Calc spreadsheet and the results displayed in an embedded Impress spreadsheet or even better in a native Impress table.

Alternatively, choose **Insert > Object > OLE Object** from the menu bar. This opens a spreadsheet in the middle of the slide and the menus and toolbars change to those used in Calc so that you can start adding data, though you may first need to resize the visible area on the slide. You can also insert an already existing spreadsheet and use the viewport to select the data that you want to display on your slide.

Impress offers the capability of inserting in a slide various other types of objects such as Writer documents, Math formulas, or even another presentation. For details on using these objects, refer to Chapter 7 of the *Impress Guide*.

Working with slide masters and styles

A *slide master* is a slide that is used as the starting point for other slides. It is similar to a page style in Writer: it controls the basic formatting of all slides based on it. A slide show can have more than one slide master.

Note

OOo uses three terms for a slide that is used to create other slides: *master slide*, *slide master*, and *master page*. This book uses the term *slide master*, except when describing the user interface.

A slide master has a defined set of characteristics, including the background color, graphic, or gradient; objects (such as logos, decorative lines, and other graphics) in the background; headers and footers; placement and size of text frames; and the formatting of text.

Styles

All of the characteristics of slide masters are controlled by *styles*. The styles of any new slide you create are inherited from the slide master from which it was created. In other words, the styles of the slide master are available and applied to all slides created from that slide master. Changing a style in a slide master results in changes to all the slides based on that slide master, but you can modify individual slides without affecting the slide master.

Slide masters have two types of styles associated with them: *presentation styles* and *graphic styles*. The prepackaged presentation styles can be modified, but new presentation styles cannot be created. In the case of graphic styles, you can modify the prepackaged ones and also create new ones.

Presentation styles affect three elements of a slide master: the background, background objects (such as icons, decorative lines, and text frames), and the text placed on the slide. Text styles are further divided into *Notes*, *Outline 1* through *Outline 9*, *Subtitle*, and *Title*. The outline styles are used for the different levels of the outline to which they belong. For example, Outline 2 is used for the subpoints of Outline 1, and Outline 3 is used for the subpoints of Outline 2.

Graphic styles affect many of the elements of a slide. Notice that text styles exist in both the presentation and graphic style selections.

Slide masters

Impress comes with several prepackaged slide masters. They are shown in the Master Pages section of the Tasks pane. This section has three subsections: *Used in This Presentation*, *Recently Used*, and *Available for Use*. Click the + sign next to the name of a subsection to expand it to show thumbnails of the slides, or click the - sign to collapse the subsection to hide the thumbnails.

Each of the slide masters shown in the *Available for Use* list is from a template of the same name. If you have created your own templates, or added templates from other sources, slide masters from those templates will also appear in this list.



Figure 146: Available master pages (slides)

Creating a slide master

Creating a new slide master is similar to modifying the default slide master. To start, enable editing of slide masters by **View > Master > Slide Master**.

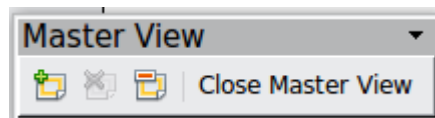

On the Master View toolbar, click the **New Master** icon. 

A second slide master appears in the Slides pane. Modify this slide master to suit your requirements. It is also recommended that you rename this new slide master: right-click on the slide in the Slides pane and select **Rename master** from the pop-up menu.

When you are done, close the Master View toolbar to return to normal slide editing mode.

Applying a slide master

In the Tasks Pane, be sure the Master Pages section is showing.

To apply one of the slide masters to *all slides* in your presentation, click on it in the list.

To apply a different slide master to one or more *selected slides*:

- 1) In the Slide Pane, select the slides you want to change.
- 2) In the Tasks Pane, right-click on the slide master you want to apply to the selected slides, and click **Apply to Selected Slides** on the pop-up menu.

Loading additional slide masters

Sometimes, in the same set of slides, you may need to mix multiple slide masters that may belong to different templates. For example, you may need a completely different layout for the first slide of the presentation, or you may want to add to your presentation a slide from a different presentation (based on a template available on the hard disk).

The Slide Design dialog makes this possible. Access this dialog either from the menu bar (**Format > Slide design**) or by right-clicking on a slide in the Slides pane.

The main window in the dialog shows the slide masters already available for use. To add more:

- 1) Click the **Load** button.
- 2) Select in the new dialog the template containing the slide master. Click **OK**.
- 3) Click **OK** again to close the slide design dialog.

The slide masters in the template you selected are now shown also in the Master Pages section of the Tasks pane in the *Available for use* subsection.

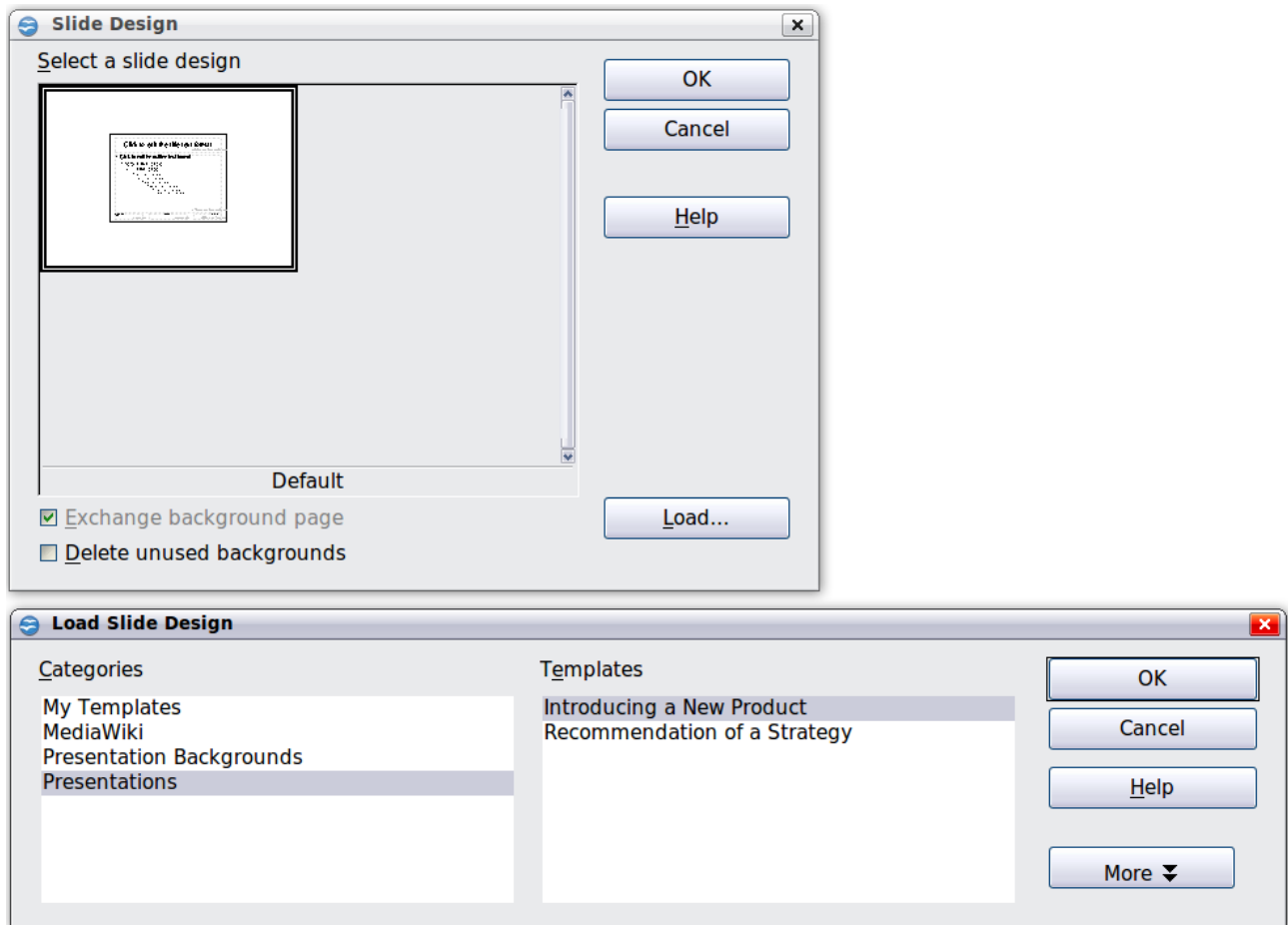

Figure 147: Loading slide masters from a presentation template

Note

The slide masters you have loaded will also be available the next time you load the presentation. If you want to delete the unused slide masters, click the corresponding checkbox in the Slide Design dialog. Due to a bug, if the slide master was not used in the presentation, it is removed from the list of available slide masters anyway.

Tip

To limit the size of the presentation file, you may want to minimize the number of slide masters used.

Modifying a slide master

The following items can be changed on a slide master:

- Background (color, gradient, hatching, or bitmap)
- Background objects (for example, add a logo or decorative graphics)
- Size, placement, and contents of header and footer elements to appear on every slide
- Size and placement of default frames for slide titles and content

Before working on the slide master, make sure that the Styles and Formatting window is open.

To select the slide master for modification:

- 1) Select **View > Master > Slide Master** from the menu bar. This unlocks the properties of the slide master so you can edit it.
- 2) Click *Master Pages* in the Tasks pane. This gives you access to the pre-packaged slide masters.
- 3) Click on the slide master you want to modify among the ones available (Figure 146).
- 4) Make changes as required, then click the **Close Master View** icon on the Master View toolbar. For details, see Chapter 2 of the *Impress Guide*
- 5) Save the file before continuing.

Caution

Any changes made to one slide when in Master View mode will appear on *all* slides using this slide master. Always make sure you close Master View and return to Normal view before working on any of the presentation slides. Select **View > Normal** from the menu bar, or click **Close Master View** in the Master View toolbar to return to the normal slide view.

The changes made to one of the slides in Normal view (for example changes to the bullet point style or the color of the title area and so on...) will not be overridden by subsequent changes to the slide master. There are cases, however, where it is desirable to revert a manually modified element of the slide to the style defined in the slide master: to do that, select that element and choose **Format > Default Formatting** from the menu bar.

Using a slide master to add text to all slides

Some of the supplied slide masters have text objects in the footer. You can add other text objects to the master page for your slides to act as a header or a footer.

- 1) Choose **View > Master > Slide Master** from the menu bar.
- 2) On the **Drawing** toolbar, select the **Text** icon.
- 3) Click once and drag in the master page to draw a text object, and then type or paste your text into the object or add fields as described below.
- 4) Choose **View > Normal** when you are finished.

The Impress slide master comes with three pre-configured areas for date, footer and page number.

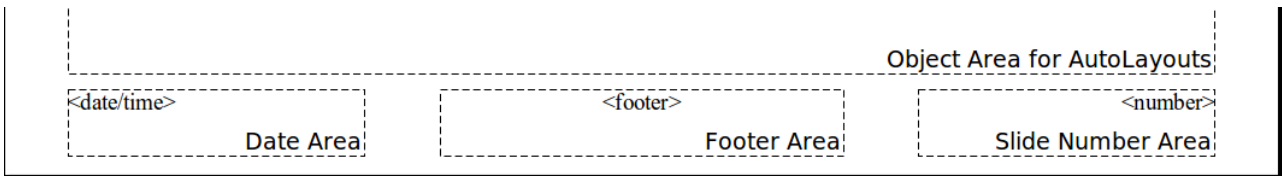

Select **Insert > Page Number** or **Insert > Date and Time** to open a dialog box where you can configure these three areas.

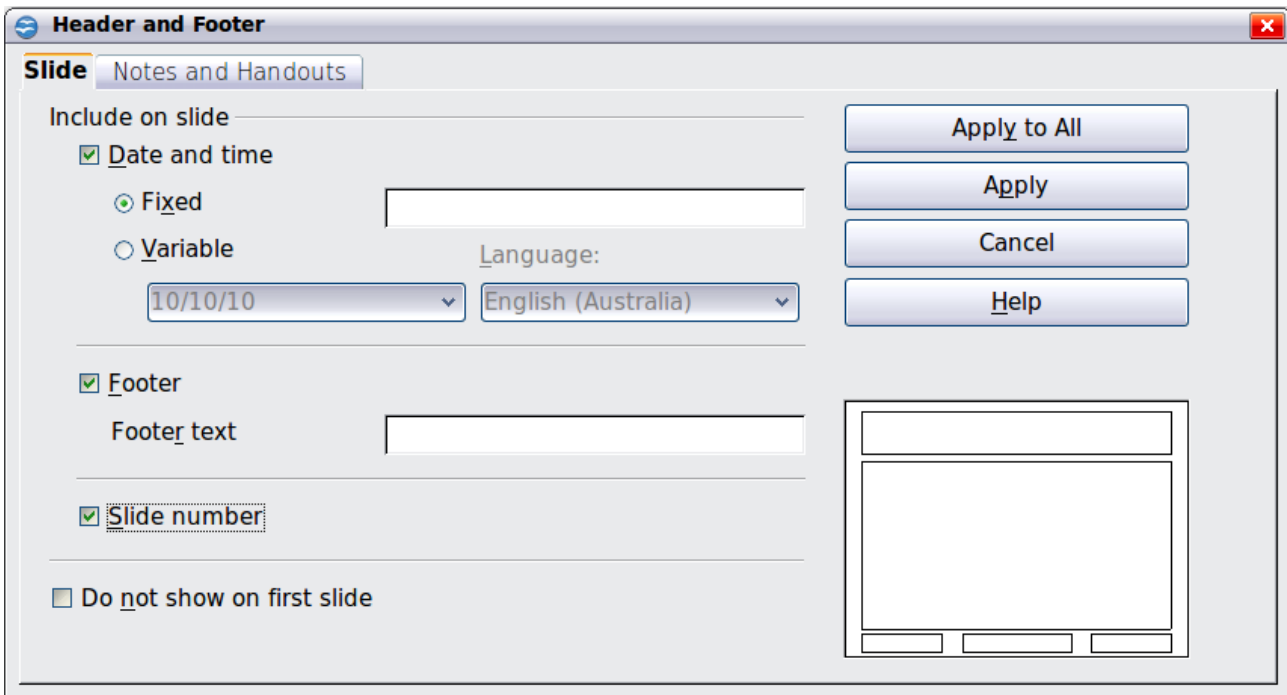

Figure 148: Configuring the slide footer areas

Tip

To change the number format (1,2,3 or a,b,c or i,ii,iii, etc.) for the page number field, choose **Format > Page** and then select a format from the list in the **Layout Settings** area.

To change the paragraph style modify the Background Objects Presentation style.

To add a other information, such as the Author of the presentation or the name of the file, choose **Insert > Fields**. and select the required field from the submenu. If you want to edit a field in your slide, select it and choose **Edit > Fields**.

The fields you can use in Impress are:

- Date (fixed)
- Date (variable)—updates automatically when you reload the file
- Time (fixed)
- Time (variable)—updates automatically when you reload the file
- Author—First and last names listed in the OpenOffice.org user data
- Page number (slide number)
- File name

Tip

To change the author information, go to **Tools > Options > OpenOffice.org > User Data**.

Adding comments to a presentation

Starting with OOO 3.2, Impress supports comments (formerly called sticky notes) similar to those in Writer and Calc.

In Normal View, choose **Insert > Comment** from the menu bar. A small box containing your initials appears in the upper left-hand corner of the slide, with a larger text box beside it (see Figure 149). Impress has automatically added your name and the date at the bottom of this text box.

Type or paste your comment into the text box. You can optionally apply some basic formatting to parts of the text by selecting it, right-clicking, and choosing from the pop-up menu. (From this menu, you can also delete the current comment, all the comments from the same author, or all the comments in the document.)

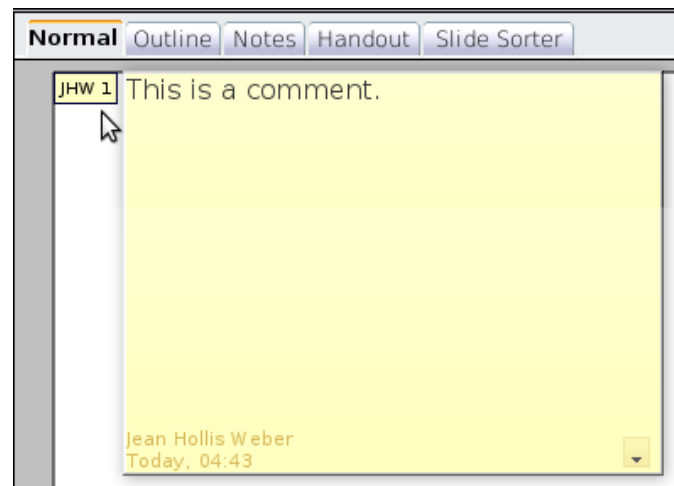

Figure 149: A comment

You can move the small comment markers to anywhere you wish on the page. Typically you might place it on or near an object you refer to in the comment.

To show or hide the comment markers, choose **View > Comments**.

Select **Tools > Options > User Data** to configure the name you want to appear in the Author field of the comment, or to change it.

If more than one person edits the document, each author is automatically allocated a different background color.

Setting up the slide show

As mentioned in “Modifying the slide show” on page 159, Impress allocates reasonable default settings for slide shows, while at the same time allowing for customizing many aspects of the slide show experience. This section covers only some aspects; advanced techniques are explained in Chapter 9 (Slide Shows) in the *Impress Guide*.

Most of the tasks are best done in Slide Sorter view where you can see most of the slides simultaneously. Choose **View > Slide Sorter** from the menu bar or click the Slide Sorter tab at the top of the workspace.

One slide set - multiple presentations

In many situations, you may find that you have more slides than the time available to present them or you may want to provide a rapid overview without dwelling on the details. Rather than having to create a new presentation, you can use two tools that Impress offers: hiding slides and custom slide shows.

To hide a slide, right-click on the slide thumbnail either in the Slide pane or in the work area if you are using the Slide Sorter view and choose **Hide Slide** from the pop-up menu. Hidden slides are marked by a slashed slide number.

If you want to reorder the presentation, choose **Slide Show > Custom Slide Show**. Click on the **New** button to create a new sequence of slides and save it.

You can have as many slide shows as you want from a single slide set.

Slide transitions

Slide transition is the animation that is played when a slide is changed. You can configure the slide transition from the Slide Transition drawer in the Tasks pane. Select the desired transition, the speed of the animation, and whether the transition should happen when you click the mouse (preferred) or automatically after a certain number of seconds. Click **Apply to all slides** unless you prefer to have different transitions in the presentation.

Tip

The Slide transition section has a very useful choice: *Automatic preview*. Select its checkbox. Then when you make any changes in a slide transition, the new slide is previewed in the Slide Design area, including its transition effect.

Automatic slides advance

You can set the presentation to automatically advance to the next slide after a set amount of time (for example kiosk mode or carousel) from the **Slide Show > Slide Show Settings** menu or to advance automatically after a pre-set amount of time different for each slide. To set up the latter, choose **Slide Show > Rehearse Timings**. When using this tool, start the slide show; a small timer is displayed in the bottom left corner. When you are ready to advance to the next slide, click on the timer. Impress will memorize the timings and at the next slide show will advance automatically after the timer expires.

Running the slide show

To run the slide show, do one of the following:

- Click **Slide Show > Slide Show**.
- Click the **Slide Show** button on the Presentation toolbar.



- Press *F5* or *F9* on the keyboard.

If the slide transition is *Automatic after x seconds*, let the slide show run by itself.

If the slide transition is *On mouse click*, do one of the following to move from one slide to the next:

- Use the arrow keys on the keyboard to go to the next slide or to go back to the previous one.
- Click the mouse to move to the next slide.
- Press the spacebar on the keyboard to advance to the next slide.

Right-click anywhere on the screen to open a menu from which you can navigate the slides and set other options.

To exit the slide show at any time including at the end, press the *Esc* key.

Chapter 7

Getting Started with Draw

Vector Drawing in OpenOffice.org

What is Draw?

Draw is a vector graphics drawing program, although it can also perform some operations on raster graphics (pixels). Using Draw, you can quickly create a wide variety of graphical images.

Vector graphics store and display an image as simple geometric elements such as lines, circles, and polygons rather than a collections of pixels (points on the screen). Vector graphics allow for easier storage and scaling of the image.

Draw is fully integrated into the OpenOffice.org (OOo) suite, and this simplifies exchanging graphics with all components of the suite. For example, if you create an image in Draw, reusing it in a Writer document is as simple as copying and pasting the image. You can also work with drawings directly from within Writer or Impress, using a subset of the functions and tools from Draw.

Draw's functionality is extensive; even though it was not designed to rival high-end graphics applications, it possesses more functions than the drawing tools that are integrated with office productivity suites.

A few examples of drawing functions are:

- Layer management
- Magnetic grid point system
- Dimensions and measurement display
- Connectors for making organization charts
- 3D functions that enable small three-dimensional drawings to be created (with texture and lighting effects)
- Drawing and page style integration
- Bézier curves

This chapter introduces some of Draw's features, but it does not attempt to cover all of them. See the *Draw Guide* and the application Help for more information.

The Draw workspace

The main components of the Draw workspace are shown in Figure 150.

You can surround the drawing area with toolbars and information areas. The number and position of the visible tools vary with the task in hand and user preferences. Therefore, your setup may look different. For example, many users put the main Drawing toolbar on the left-hand side of the workspace, not at the bottom as shown here.

You can split drawings in Draw over several pages. Multipage drawings are used mainly for presentations. The *Pages* pane, on the left side of the Draw window in Figure 150 gives an overview of the pages that you create. If the Pages pane is not visible on your setup, you can enable it from the View menu (**View > Page Pane**).

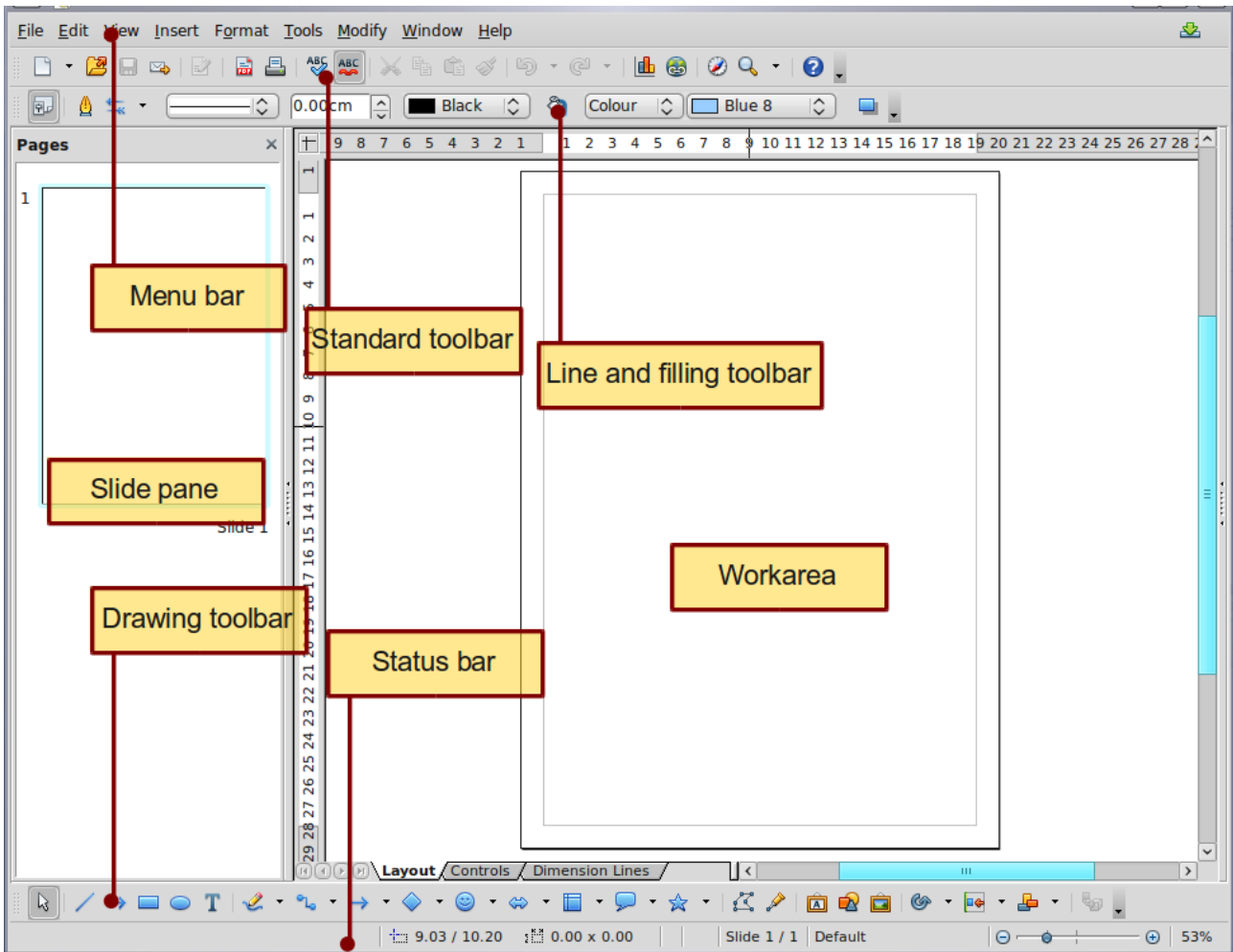

Figure 150. Initial Draw window

Rulers

You should see rulers (bars with numbers) on the upper and left-hand side of the workspace. The rulers show the size of a selected object on the page (see the gray double lines, highlighted in Figure 151). When no object is selected, they show the location of the mouse pointer, which helps to accurately position drawing objects more accurately.

You can also use the rulers to manage object handles and guide lines, making it easier to position objects. The page margins in the drawing area are also represented on the rulers. You can change the margins directly on the rulers by dragging them with the mouse.

To modify the unit of measurement of a ruler, right-click on the ruler and select one of the measurement units. The two rulers can have different units.

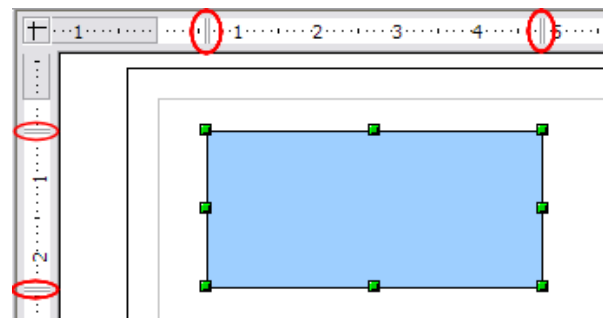

Figure 151: Rulers show the size of the selected object

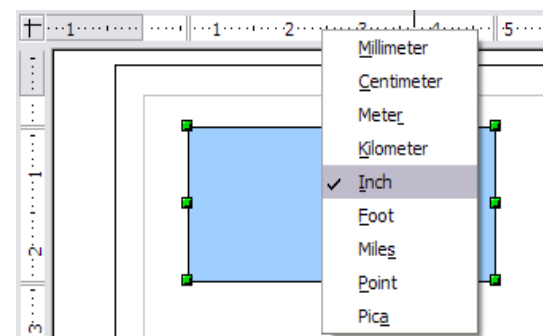

Figure 152. Ruler units

Status bar

The Status bar is located at the bottom of the screen (in all OOO components); it includes several Draw-specific fields.

For details on the contents and use of these fields, see Chapter 1 (Introducing OpenOffice.org) in this book and Chapter 1 (Introducing Draw) in the *Draw Guide*.

Note

The sizes are given in the current measurement unit (not to be confused with the ruler units). This unit is defined in **Tools > Options > OpenOffice.org Draw > General**, where you can also change the scale of the page. Another way to change the scale is to double-click on the number shown in the status bar.

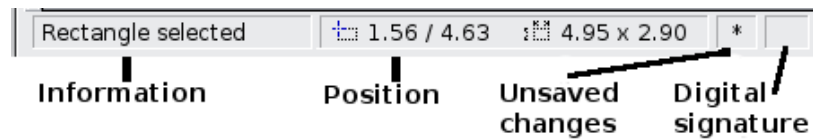

Figure 153: Left end of the Draw status bar

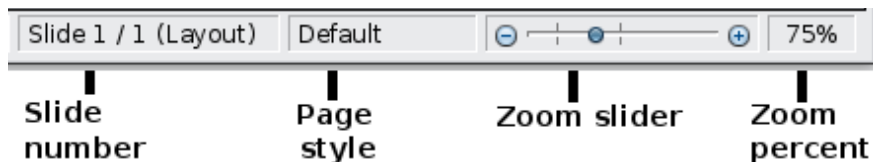

Figure 154: Right end of Draw status bar

Toolbars

To display or hide the various Draw toolbars, choose **View > Toolbars**. On the menu that appears, select which toolbars you want to display. For more about working with toolbars, see Chapter 1 (Introducing OpenOffice.org) in this book.

The tools available in the Draw toolbars are explained in the following sections. The appearance of the toolbar icons may vary depending on your operating system and the selection of icon size and style in **Tools > Options > OpenOffice.org > View**.

Standard toolbar

The Standard toolbar is the same for all OpenOffice.org components and is not described in detail in this chapter.



Line and Filling toolbar

The Line and Filling toolbar lets you modify the main properties of a drawing object. See page 193 for details.

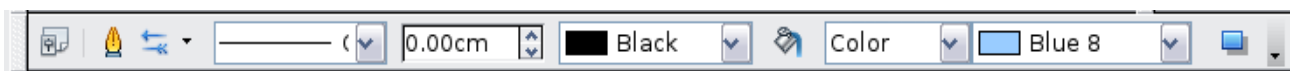

Text Formatting toolbar

If the selected object is text, the toolbar changes to the Text Formatting toolbar, which is similar to the Formatting toolbar in Writer. For more information, see Chapter 4 (Getting Started with Writer) in this book.



Drawing toolbar

The Drawing toolbar is the most important toolbar in Draw. It contains all the necessary functions for drawing various geometric and freehand shapes and for organizing them on the page.



Options toolbar

Use the Options toolbar to activate or deactivate various drawing aids. To display the Options toolbar, select **View > Toolbars > Options**.



Figure 155: Options toolbar

Choosing and defining colors

Color Bar

To display the Color Bar, use **View > Toolbars > Color Bar**. The toolbar then appears at the bottom of the workspace.



This toolbar lets you rapidly choose the color of the objects in your drawing. The first box in the panel corresponds to transparency (no color).

You can access several specialized color palettes in Draw, as well as change individual colors to your own taste. To do this, choose **Format > Area** or the *pouring can* icon on the Line and Filling toolbar. This opens the Area dialog. Choose the **Colors** tab.

To load another palette, click on the **Load Color List** button (circled). The file selector dialog asks you to choose one of the standard OOo palettes (files bearing the file extension *.soc). For example, *web.soc* is a color palette that is particularly adapted to creating drawings that are going to appear in Web pages. The colors will correctly display on workstations with screens displaying at least 256 colors.

The color selection box also lets you individually change any color by modifying the numerical values in the fields provided to the right of the color palette. You can use the color schemes known as CMYK (Cyan, Magenta, Yellow, Black), and RGB (Red, Green, Blue).

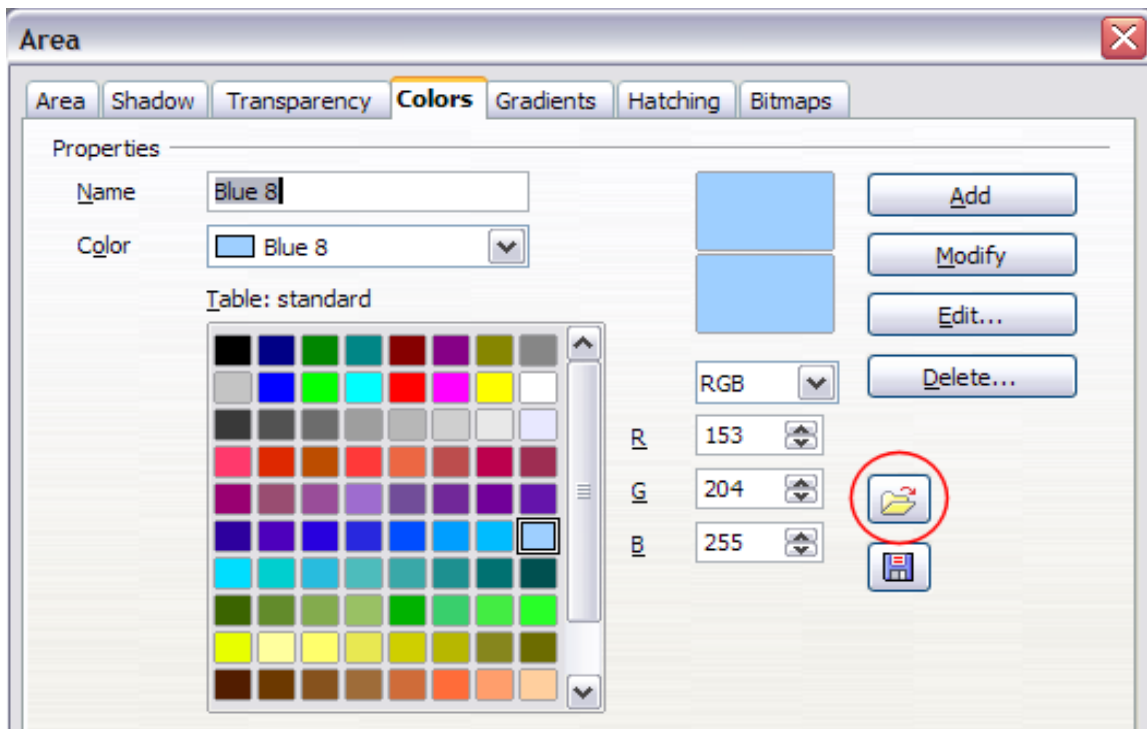

Figure 156. Changing the color palette

Click on the **Edit** button to open the Color dialog, where you can set individual colors. See “Color options” in Chapter 2 (Setting Up OpenOffice.org) of this book. Many more input possibilities are available in this dialog.

For a more detailed description of color palettes and their options, see Chapter 8 (Tips and Tricks) in the *Draw Guide*.

Positioning objects with snap functions

In Draw, objects can be accurately and consistently positioned using grid points, special snap points and lines, object frames, individual points on objects, or page edges. This function is known as *Snap*.

The snap function is easier to work with at the highest practical zoom value. You can use two different snap functions at the same time, for example snapping to a guide line and to the page edge. It is best, however, to activate only those functions that you really need.

This section summarizes the snap-to-grid function. For more detailed information about the snap functions, see Chapter 8 (Tips and Tricks) and Chapter 10 (Advanced Draw Techniques) in the *Draw Guide*.

Snap to grid

Use this function to move an object exactly to a grid point (see Figure 157). This function can be switched on and off with **View > Grid > Snap to Grid** and on the

Options toolbar with the icon .

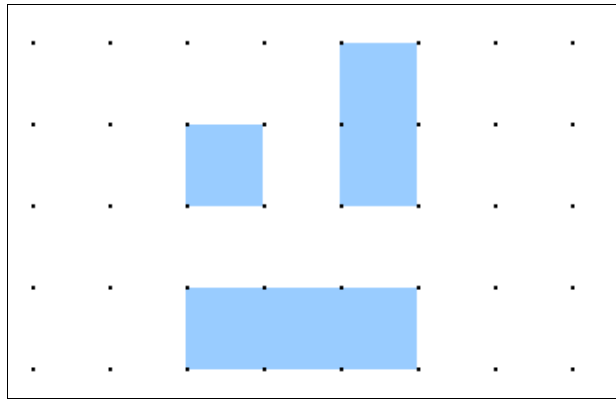



Figure 157: Exact positioning with snap to grid

Showing the grid

To make the grid visible, choose **View > Grid > Display Grid**. Alternatively, turn the grid on (or off) with the icon  on the Options toolbar.

Configuring the grid

The color, spacing, and resolution of the grid points can be individually chosen for each axis. The spacing between the lines is defined in the Grid options dialog (**Tools > Options > OpenOffice.org Draw > Grid**).

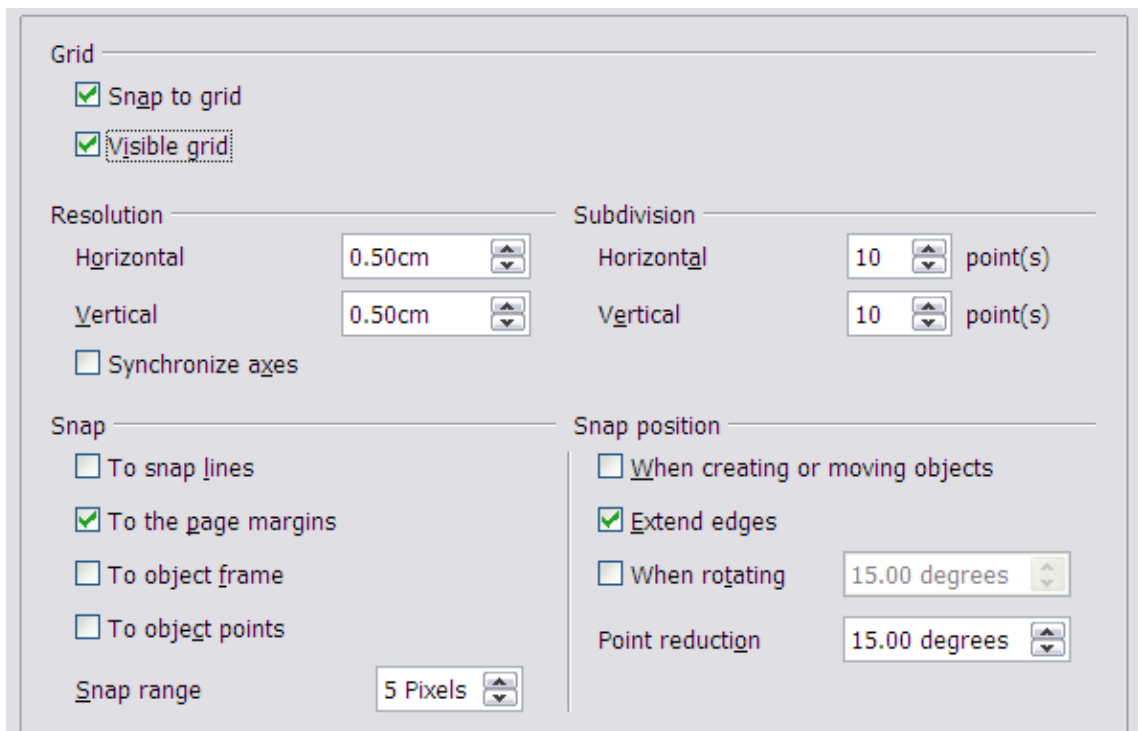

Figure 158: Setting grid options

In the dialog shown in Figure 158, you can set the following parameters:

- Vertical and horizontal spacing of the dots in the grid. You can also change the unit of measurement used in the general Draw options (**Tools > Options > OpenOffice.org Draw > General**).

- The resolution is the size of the squares or rectangles in the grid. If the resolution is Horizontal 1 cm, Vertical 2 cm, the grid consists of rectangles 2 cm high and 1 cm wide.
- Subdivisions are additional points that appear along the sides of each rectangle or square in the grid. Objects snap to subdivisions as well as to the corners of the grid.
- The pixel (pix element) size of the snap area defines how close you need to bring an object to a snap point or line before it will snap to it.

Changing the color of the grid points

The default grid dots are light gray, which can be hard to see. To change the color of the grid points, choose **Tools > Options > OpenOffice.org > Appearance**.

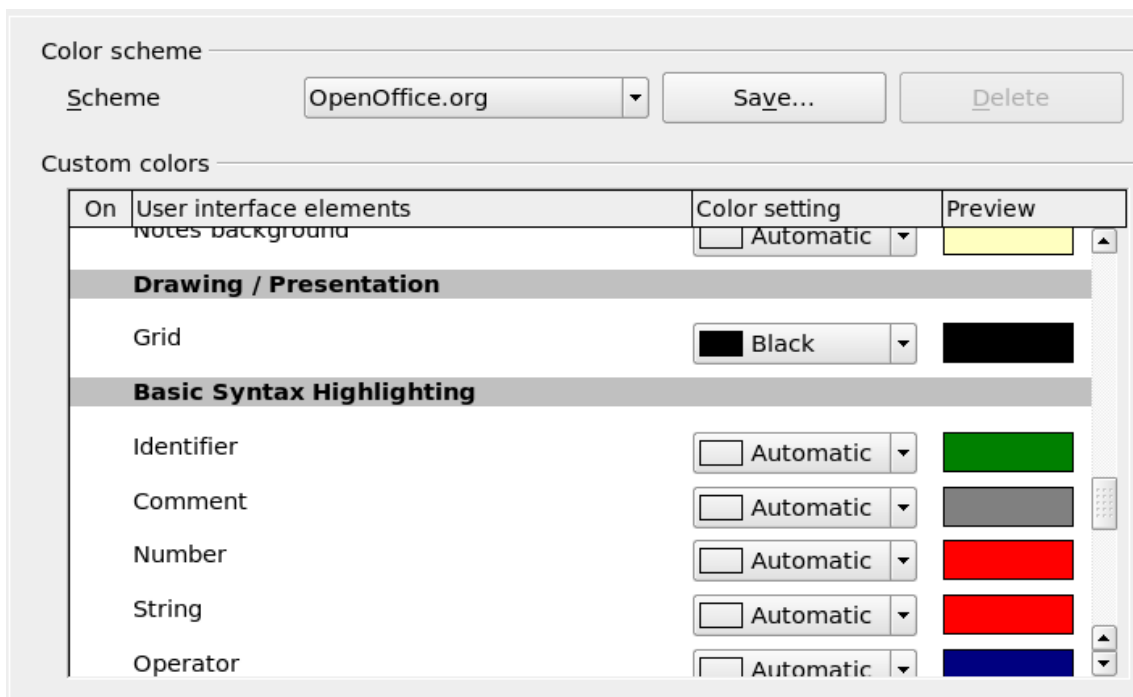

Figure 159: Changing the grid color

In the *Drawing / Presentation* section, you can change the color of the grid points. On the *Color Settings* pulldown menu, select a more suitable/visible color, for example black.

Positioning objects with guiding lines

To simplify the positioning of objects it is possible to make visible guiding lines—extensions of the edges of the object—while it is being moved. These guiding lines have no snap function.

The guiding lines can be activated or deactivated under **Tools > Options >**

OpenOffice.org Draw > View > Guides when moving, or by clicking on the  icon on the *Options* toolbar.

The basic drawing shapes

Draw provides a wide range of shapes, located in palettes accessed from the Drawing Toolbar. This section describes only a few of the basic shapes. These shapes include; rectangles and squares, circles, ellipses, and arcs, 3D objects, curves, lines and arrows, text, and connectors. All shapes in Draw are called *objects*. See the *Draw Guide* for a complete description of the shapes available.

Note When you draw a basic shape or select one for editing, the *Info* field at the left side in the status bar changes to reflect the present action: *Line created*, *Text frame xxyy selected*, and so on.

Figure 160 shows part of the Drawing toolbar with the icons needed in the following sections. The *Text* icon is also included.



Figure 160: Part of the Drawing toolbar

Drawing a straight line

Click on the **Line** icon  on the Drawing toolbar and position the mouse pointer where you want to start the line. Drag the mouse while keeping the button pressed. Release the mouse button at the point where you want to end the line.

A selection handle appears at each end of the line, showing that this is the currently selected object.

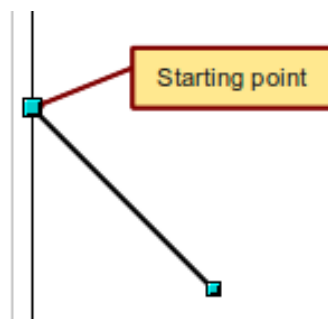

Figure 161: Drawing a straight line

To restrict the angle of the line to a multiple of 45 degrees (0, 45, 90, 135, and so on), hold down the *Shift* key while you draw the line.

To snap the end of the line to the nearest grid point, hold down the *Control (Ctrl)* key pressed while drawing the line.

Note The effect of the *Ctrl* key depends on the settings of the **Snap to Grid** option on the **View > Grid** menu:
Snap to Grid on: *Ctrl* deactivates the snap option for this activity.
Snap to Grid off: *Ctrl* activates the snap option for this activity.

To extend the line symmetrically in both directions from the starting point, hold down the *Alt* key while drawing the line.

To change line attributes (for example, the color or line type), select the line by clicking on it, then use the tools in the Line and Filling toolbar; or for more control, right-click on the line and choose **Line** to open the Line dialog.

Drawing an arrow

Arrows are drawn like lines. Draw classifies arrows as a subgroup of lines: Lines with arrowheads. The information field on the status bar shows them only as lines. Click on the **Line Ends with Arrow** icon  to draw an arrow.

Choosing line endings

Several types of line endings (arrows, circles, squares, and others) are available in Draw. Choose **View > Toolbars > Arrows**, or click on the small black triangle on the

Lines and Arrows  icon on the Drawing toolbar, to open a toolbar with ten tools for drawing lines and arrows. The last-used command is stored on the toolbar to make it quicker to call it up again.

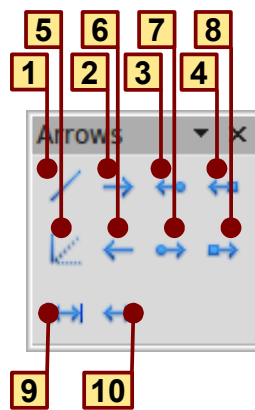

- | | | |
|---------------------------------|---------------------------------|---------------------------------|
| 1 Line | 5 Line (45°) | 8 Line with square/arrow |
| 2 Line Ends with Arrow | 6 Line starts with arrow | 9 Dimension line |
| 3 Line with arrow/circle | 7 Line with circle/arrow | 10 Line with arrows |
| 4 Line with arrow/square | | |

Figure 162: Arrows toolbar

Drawing a rectangle or square

Drawing a rectangle is similar to drawing a straight line, except that you click on the **Rectangle** icon  from the Drawing toolbar, and the (imaginary) line drawn by the mouse corresponds to a diagonal of the rectangle. The rectangle changes shape as you drag the mouse around.

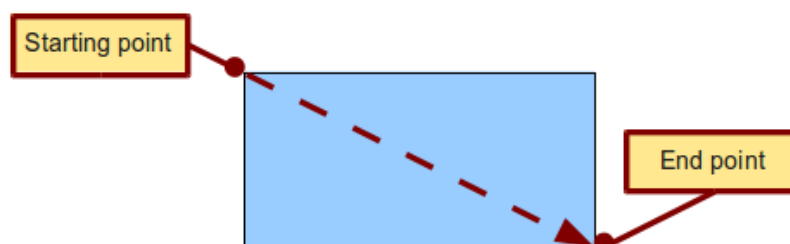



Figure 163: Drawing a rectangle

Hold down the *Shift* key to draw a square. Hold down the *Alt* key to draw a rectangle starting from its center. To combine the effects, hold down both the *Shift* and *Alt* keys simultaneously.

Drawing a circle or ellipse

To draw an ellipse (also called an oval) or a circle, use the Ellipse icon  from the Drawing toolbar. (A circle is simply an ellipse with both axes the same length.) The ellipse drawn is the largest ellipse that fits inside the (imaginary) rectangle drawn with the mouse.

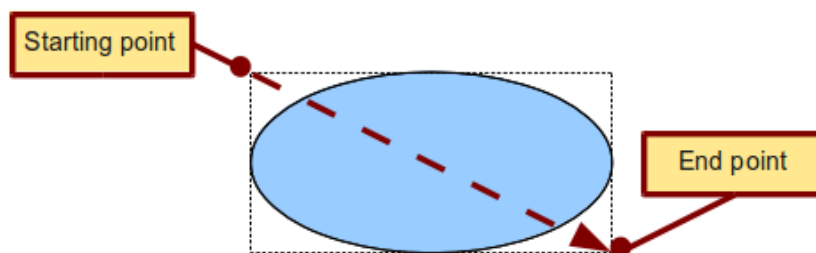

Figure 164: Drawing an ellipse

Here are some other ways to draw an ellipse or circle:

- To draw a circle, hold down the *Shift* key while dragging the mouse.
- To draw an ellipse with the starting point at the center (instead of the corner), hold down the *Alt* key while dragging the mouse.
- To draw a circle with the starting point at the center, hold down both the *Alt* and *Shift* keys while dragging the mouse.
- To draw an ellipse or circle that snaps to the nearest grid points, hold down the *Ctrl* key while dragging the mouse.

Note

If you first press and hold down the *Ctrl* key and then click on one of the icons for Line, Rectangle, Ellipse, or Text, a standard sized object is drawn automatically in the work area; the size, shape, and color are all standard values. These attributes can be changed later, if desired.

Drawing curves

The tools for drawing curves or polygons are on the toolbar that appears when you click arrow next to the **Curve** icon  on the Drawing toolbar. This toolbar contains eight tools (Figure 165).

If you move the mouse cursor over one of the icons, a tooltip pops up with a description of the function.

Note

Hovering the mouse pointer over this icon gives a tooltip of *Curve*. If you convert the icon to a floating toolbar, however, the title is *Lines*, as shown in Figure 165.

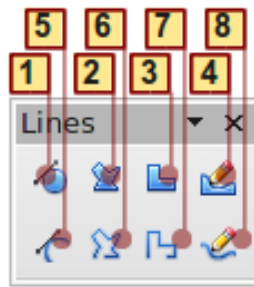

- | | | |
|--------------------------------|--------------------------------|------------------------|
| 1 Curve, filled | 4 Freeform line, Filled | 7 Polygon (45°) |
| 2 Polygon, filled | 5 Curve | 8 Freeform line |
| 3 Polygon (45°), filled | 6 Polygon | |

Figure 165: Curves toolbar (incorrectly titled "Lines")

Polygons

Draw the first line from the start point with the left mouse button held down. As soon as you release the mouse button, a first corner point is drawn; move the mouse to see how the second line will look. Every mouse click sets another corner point. A double-click ends the drawing. A filled polygon automatically joins the last point to the first point to close off the figure and fills it with the current standard fill color. A polygon without filling will not be closed at the end of the drawing.

Polygon 45°

Like ordinary polygons, these are formed from lines but with angles of 45 or 90 degrees between them.

Freeform line

With this tool you can draw just like with a pencil. Press and hold the left mouse button and drag the mouse. It is not necessary to end the drawing with a double-click. Just release the mouse button and the drawing is completed. If you have selected *Freeform Line, Filled*, the end point is joined automatically to the start point and the object is filled with the appropriate color.

Curves and filled curves

For a description of the handling of curves and filled curves, see Chapter 10 (Advanced Draw Techniques) in the *Draw Guide*.

Writing text

Use the Text tool **T** to write text and select the font, color, size, and other attributes. Click at the location where you want to position the text or click and drag to create a larger text frame. Press *Enter* to move the cursor to the next line.

When you have finished typing text, click outside the text frame. Double-click on the text at any time to edit it.

When you use the Text tool, the Text formatting toolbar is visible; it includes the usual paragraph attributes: indents, first line, and tab stops.

You can create Graphics styles that you can reuse for other text frames. Select **Format > Styles and Formatting** or press *F11* to open the Styles and Formatting window. Graphics styles affect all of the text within a text frame. To style parts of the text, use direct formatting with the toolbar.

Text frames can also have fill colors, shadows, and other attributes, just like any other Draw object. You can rotate the frame and write the text at any angle. These options are available by right-clicking on the object.

Use the Callout tool , located on the Drawing toolbar, to create callouts (also known as captions or figure labels).

If you double-click on an object or press *F2* (or the **Text** icon in the Drawing toolbar) when an object is selected, text is written in the center of the object and remains within the object. Nearly any kind of object contains such an additional text element. These texts have slight differences to those in text frames concerning position and hyphenation.

For more about text, see Chapter 2 (Drawing Basic Shapes) and Chapter 10 (Advanced Draw Techniques) in the *Draw Guide*.

Gluepoints and connectors

All Draw objects have associated invisible *gluepoints*, which become visible when you choose any of the connectors under the **Connector** icon  on the Drawing toolbar and then move the mouse pointer over the object.

Most objects have four gluepoints, as shown in Figure 166. You can add more gluepoints, and customize gluepoints, using the toolbar under the Gluepoint icon  on the Drawing toolbar.

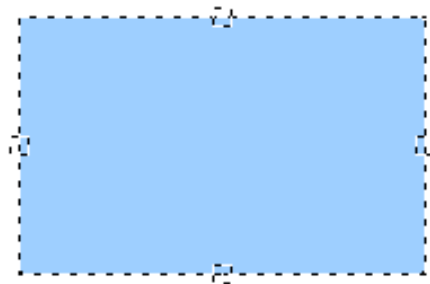

Figure 166: Four gluepoints

Gluepoints are different from handles (the small blue or green squares around an object). The handles are for moving or resizing an object. The gluepoints attach connectors to an object.

Connectors are lines or arrows whose ends automatically dock to gluepoints on an object. When you move the other object, the connector moves with it. Connectors are particularly useful for making organizational charts. You can reorganize the blocks of your chart and all the connected objects stay connected.

Figure 167 shows two Draw objects and a connector.

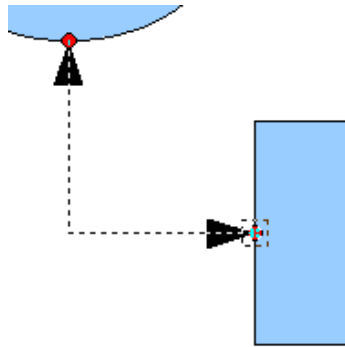



Figure 167: A connector between two objects

Draw offers a range of different connectors and connector functions. Open the floating Connector toolbar by clicking on the arrow next to the **Connector** icon . For more about connectors and gluepoints, see Chapter 9 (Organization Charts, Flow Diagrams, and More) in the *Draw Guide*.

Drawing geometric shapes

Geometric shapes include basic shapes, symbol shapes, block arrows, flowcharts, callouts, and stars.

Figure 168 shows part of the Drawing toolbar with the icons referred to in the following sections. Clicking on the arrow next to the icon opens a floating toolbar with the relevant work tools.

Tip

The use of all these tools is similar to that of the Rectangle tool, even though they produce different geometric shapes.

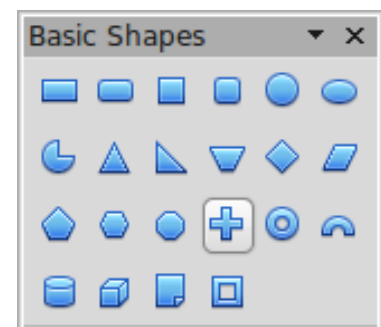

Figure 168: Part of the main Drawing toolbar

Basic shapes

The **Basic Shapes** icon  makes available the range of tools for drawing basic shapes, including a rectangular tool identical to the one on the main toolbar.

The only differences you will see are in the information field in the status bar (in this case, “shape selected” rather than “Rectangle selected”).



Symbol shapes

The **Symbol Shapes** icon  provides an array of tools for drawing the various symbols.

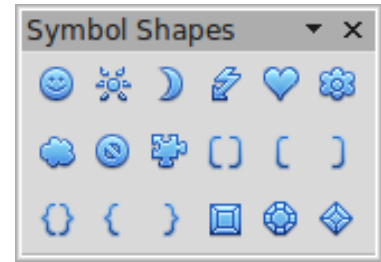

Block arrows

The **Block Arrows** icon  opens the Block Arrows toolbar.

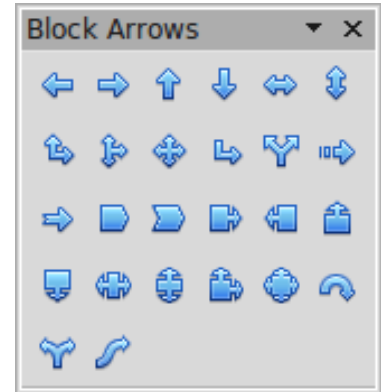

Flowcharts

The tools for drawing flowcharts are accessed by clicking on the **Flowcharts** icon .

The creation of flowcharts, organization charts, and similar planning tools are described in Chapter 9 (Organization Charts, Flow Diagrams, and More) in the *Draw Guide*.

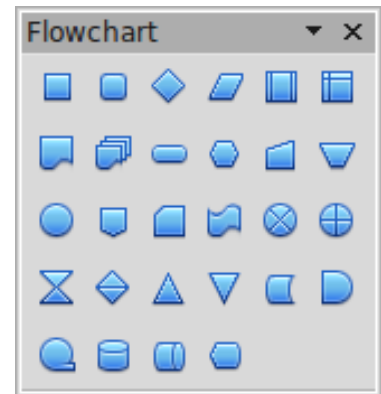

Callouts

Use the **Callouts** icon  to open the Callouts toolbar.



Stars and banners

These tools are associated with the Stars icon .

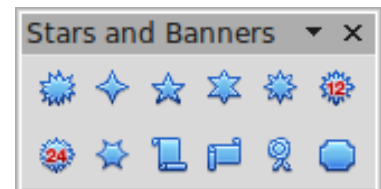

You can add text to all these shapes. See Chapter 2 (Drawing Basic Shapes) and Chapter 10 (Advanced Draw Techniques) in the *Draw Guide* for details.

Selection modes

There are three selection modes: moving and changing size, editing, and rotating points.

To set the default mode (either *moving and changing sizes* or *editing*) for selecting objects, click on the **Points** button  from the Drawing toolbar.

In standard mode (when you begin a new drawing), the Points button is not active, and the default mode is for selections to be moved or changed in size; these selections are indicated by small green squares.

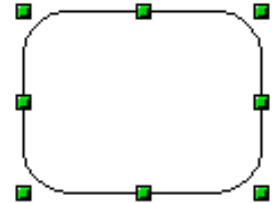

When the Points button is active, the default mode is for selections to be edited; these selections are indicated by blue squares. Some objects will have one or more extra handles, which are larger or colored differently. This is explained in more detail in Chapter 3 of the *Draw Guide*.

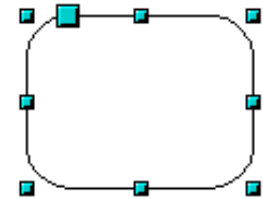



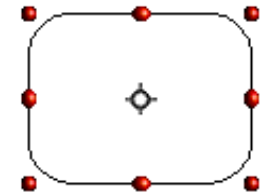

Selections for rotating objects are indicated by small red circles and a symbol representing the center of rotation. To choose these selections, click on the **Effects** drop-down button  from the Drawing toolbar.



Changing the selection mode

To go from one mode to another, you can do one of the following:

- Choose the **Points** button  from the Drawing toolbar to switch from the simple selection mode to Points mode. You can also use the keyboard shortcut *F8* (Points).
- Choose the **Effects** drop-down button from the Drawing toolbar  to activate the Rotation mode for a selected object.
- If you often work in Rotation mode, you can choose the **Rotation Mode after Clicking Object** button  from the Options bar, you can cycle through normal and rotation modes just by clicking on the object. This can be more convenient than repeatedly clicking on the object, then clicking the **Rotate** button from the Drawing Toolbar.
- To stop working in Rotation mode, click the **Rotation Mode after Clicking Object** button  again.

Selecting objects

Direct selection

The easiest way to select an object is to click directly on it. For objects that are not filled, click directly on the object's outline to select it.

Selection by framing

You can select several objects at once by using the mouse to drag a large rectangle around the objects, as shown. For this to

work, the **Select**  icon on the Drawing toolbar must be active. Only objects that lie entirely within the rectangle are selected.

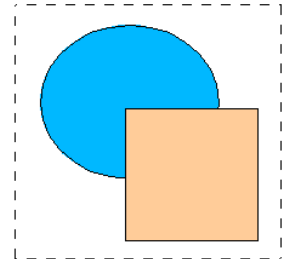

Selecting hidden objects

Even if objects are located behind others and not visible, they can still be selected. Hold down the *Alt* key and click where the object is located. If there are several overlapping objects, hold down the *Alt* key and click until you reach the object you want. To cycle through the objects in reverse order, hold down the *Alt+Shift* keys. The number and type of selected objects is shown at the left of the status bar to help you select the correct object.

Note

This method generally works in Windows, but on a Linux system it usually does not. If the *Alt* key on your system does not operate as described above, use the *Tab* key method described below.

To select an object that is covered by another object using the keyboard, press the *Tab* key to cycle through the objects, stopping at the object you wish to select. To cycle through the objects in reverse order, press *Shift+Tab*. This may not be practical if you have a large number of objects in your drawing.

When you click on the selected object, its outline will appear briefly through the objects covering it.

In the illustration to the right, the square located beneath the circle was selected in this way (the circle was made transparent in order to see the square).

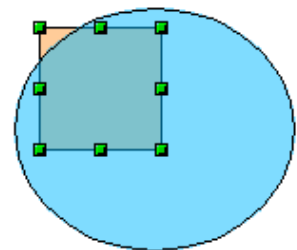

Arranging objects

In a complex drawing, several objects may be stacked on top of one another. To rearrange the stacking order (move an object to the front or to the back of the stack), select the object, choose **Modify > Arrange** and choose **Bring Forward** or **Send Backward**. Or right-click the object, choose **Arrange** from the context menu, then choose **Bring Forward** or **Send Backward**.



These options are also available from the Arrange tear-off toolbar from the button on the Drawing toolbar. A keyboard shortcut is *Shift+Ctrl+plus sign* to bring an object to the top, and *Shift+Ctrl+minus* to send an object to the bottom.

Draw also provides tools for aligning multiple objects; details are given in the *Draw Guide*.

Selecting several objects

To select or deselect several objects one by one, press the *Shift* key and click on the various objects to be selected or deselected. One click on an object selects it; a second click on the same object deselects it.

Moving and dynamically adjusting an object's size

There are several ways of moving or changing the size of an object. The *dynamic* method described here uses the mouse.

When you dynamically change an object, remember to check the left-hand area of the status bar at the bottom of the Draw window. This area shows detailed information about the ongoing manipulation. This information changes when the mouse is moved.

Dynamic movement of objects

To move an object, select it and then click within the object's border and hold down the left mouse button while dragging the mouse.

During movement, the shape of the object appears a faded version of the shape to help with repositioning.

To drop the object at its new location, release the mouse button. The new position appears immediately in the Status Bar.

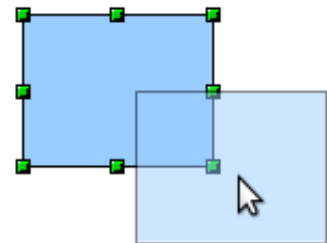

Dynamic size modification of objects

To change the size of a selected object (or group of selected objects) with the mouse, move one of the handles located around the selection. As shown in the following illustration, a faded version of the new object shape is shown.

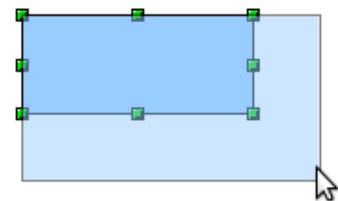

The results depend on which handle you use. To resize an object along one axis, use the appropriate side handle. To resize both axes, use a corner handle. The new size appears immediately in the status bar.

Note

If you press the *Shift* key while resizing an object, the change in size will be carried out symmetrically with respect to the two axes, so that the aspect (height/length) ratio of the object remains the same.

Rotation

Rotating an object lets you move the object around an axis. To do this dynamically (with the mouse), use the red handles, as you do when changing the size of the object.

Note

Rotation works in a slightly different way for 3D objects because the rotation occurs in 3D space and not in one plane. See Chapter 7 (Working with 3D Objects) in the *Draw Guide* regarding rotation when Edit Points mode is active.

To rotate an object (or a group of objects), drag the red corner handle point of the selection with the mouse. The mouse cursor takes the shape of an arc of a circle with an arrow at each end. A faded version of the object being rotated appears and the current angle of rotation is dynamically shown in the status bar.

Rotations are made around an axis which is displayed as a small symbol, as shown in Figure 169. You can move the axis of rotation with the mouse.

If you hold down the *Shift* key during the rotation, the operation will be carried out in increments of 15°.

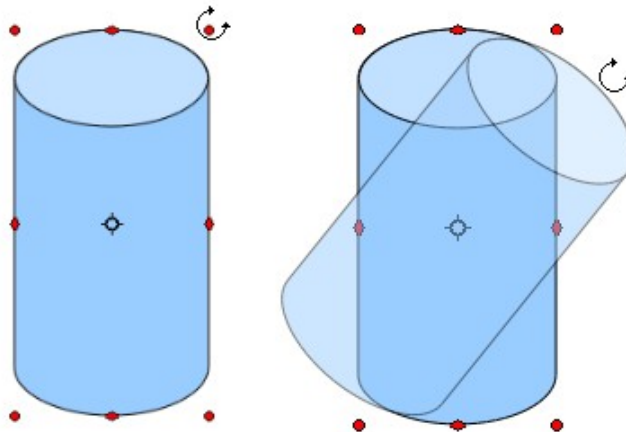

Figure 169: Rotating an object

Inclination and perspective

To slant or shear objects, use the red handles located at the midpoint of an edge of the selected objects. The mouse pointer changes to a ⇄ when the pointer hovers over one of these midpoint handles. Not every object can be slanted; basic shapes can be rotated but not slanted.

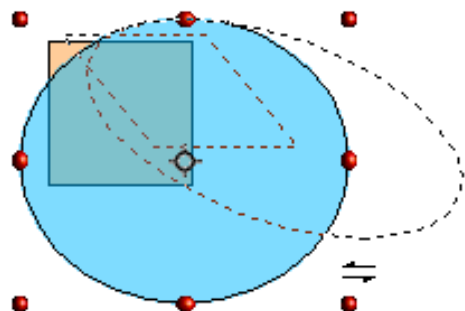

The slant axis is the point directly opposite the midpoint handle to be used for shearing the object. This point stays fixed in location; the other sides and edges move in relation to it as the mouse is dragged (make sure that the ⇄ handle icon is showing before dragging).

As with rotation, you can set the inclination (slanting) to occur in steps of 15° by pressing the *Shift* key while moving the handle.



Editing objects

To change an object's attributes (such as color and border width) you can use the Line and Filling toolbar or the context menu.

If the Line and Filling toolbar (Figure 170) is not visible, you can display it using **View > Toolbars > Line and Filling**. From here you can edit the most common object attributes. You can also open the Line dialog by clicking on the Line  icon and the Area dialog by clicking on the Area  icon to see more options.

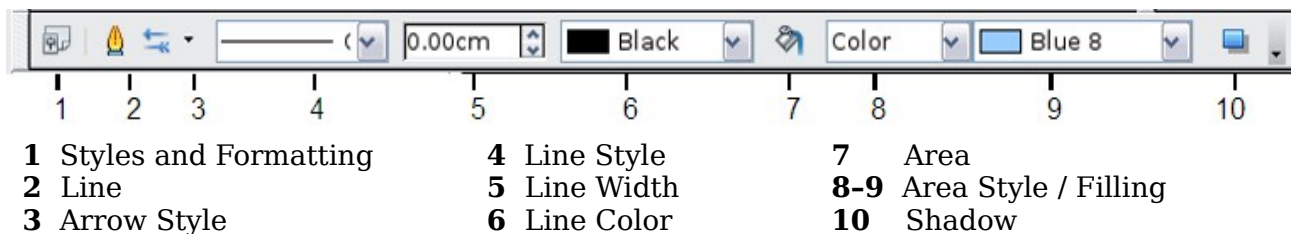

Figure 170: Line and Filling toolbar

When you select text, this toolbar changes to show text formatting options.

The context menu

When an object is selected, you can right-click on the object to bring up a context menu, which provides additional access to the options shown above and another way to change an object's attributes. The entries with a small arrow on the right-hand side contain a submenu.

Editing lines and borders

Lines, arrows, and the borders of an object are managed through the Line dialog. An object's border is just another type of line.

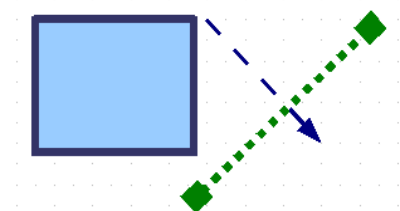

You can change some properties from the Line and Filling toolbar. To see more options, select the object and click on the Line  icon or right-click on the object and choose **Line** from the context menu. This opens the Line dialog.

Common line properties

In most cases the property you want to change is the line's style (solid, dashed, invisible, and so on), its color, or its width. These options are all available from the Line and Filling toolbar (Figure 170).

You can also edit these properties from the Line dialog, where you can also change the line's transparency. Figure 171 illustrates different degrees of transparency.

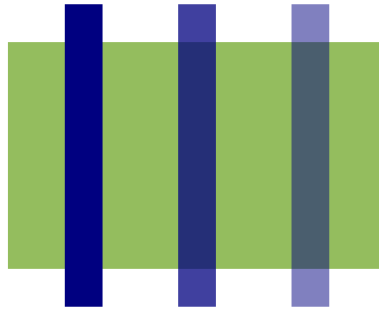



Figure 171: The vertical lines have different levels of transparency (0%, 25%, and 50%).

Drawing arrows

Arrowheads (and other line endings—usually referred to collectively as arrows) are a line property. Select a line and click on the **Arrow Style**  icon from the Line and Filling toolbar. This opens the Arrowheads menu.

Several types of arrowheads are available. Each end of the line can have a different arrowhead (or no arrowhead).

Arrowheads are only applicable to lines. They have no effect on an object's border.

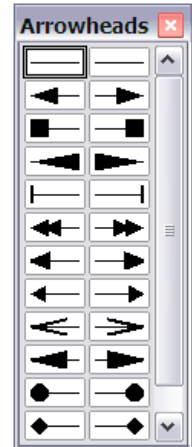

Customizing line and arrow styles

You can modify the line and arrow styles and create your own. See Chapter 4 (Changing Object Attributes) in the *Draw Guide* for details.

Editing the inside (fill) of an object

The OpenOffice.org term for the inside of an object is **Area fill**. The area fill of an object can be a uniform color, a gradient, a hatching, or an image. It can be made partly or fully transparent and can throw a shadow.

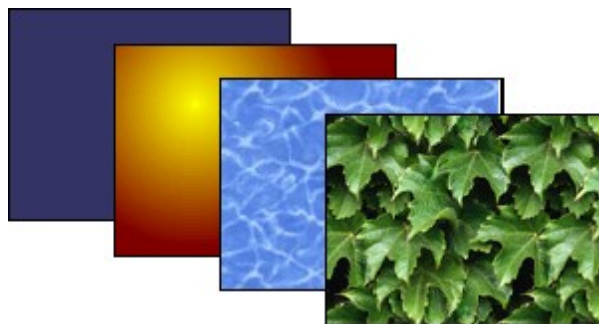

In most cases, you will choose one of the standard fill options, which are all available from the Line and Filling toolbar. You can also define your own area fills; see Chapter 4 of the *Draw Guide* for details.

Adding a shadow

In Draw, shadows are considered as an area property. Click on the Shadow  icon on the Line and Filling toolbar.

You can customize the position, distance, color, and transparency of shadows by using **Format > Area > Shadow** or by right-clicking on the selected object and choosing **Area > Shadow**.

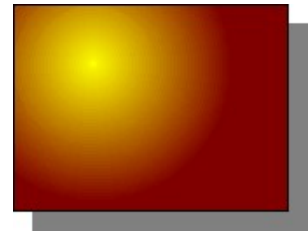

Adding transparency

You can make objects partly or fully transparent, or even with a varying degree of transparency (as a gradient).

Using styles

Suppose that you want to apply the same area fill, line thickness, and border to a set of objects. This repetitive process can be greatly simplified by the use of styles. Styles allow you to define a formatting template (a style) and then to apply that style to multiple objects. For more information about styles, see Chapter 3 (Using Styles and Templates) in this book.

Special effects

With Draw, you can apply many special effects to objects and groups of objects. This section describes a few of these effects. More effects include distorting, shadows, and transparency can be found in Chapter 4 (Changing object Attributes) of the *Draw Guide*.

Flip an object

Select an object and click on the Flip icon . You will see a dashed line through the middle of the object.

This dashed line is the axis of symmetry. The object will be flipped around this line. Move one or both ends of the line with your mouse to set the orientation of the axis.

Then, grab any one of the eight green handles and move it across to the other side of the dashed line. The new position of the figure is shown dashed until the mouse is released.

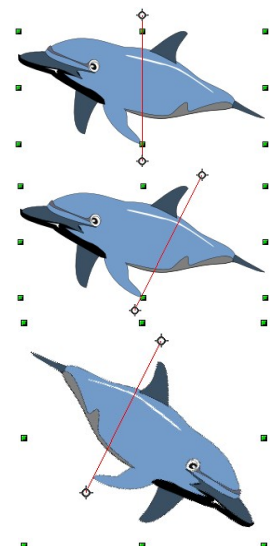

Note

If you hold down the *Shift* key while moving the line, the line will rotate in 45-degree increments.

Mirror copies

Move the axis of symmetry to the desired location of the mirror axis. Copy the object to the clipboard. Flip the object, then click on an empty area of the Draw screen in order to deselect the object. Paste from the clipboard to put a copy of the object in its original location and now you have a mirror copy.

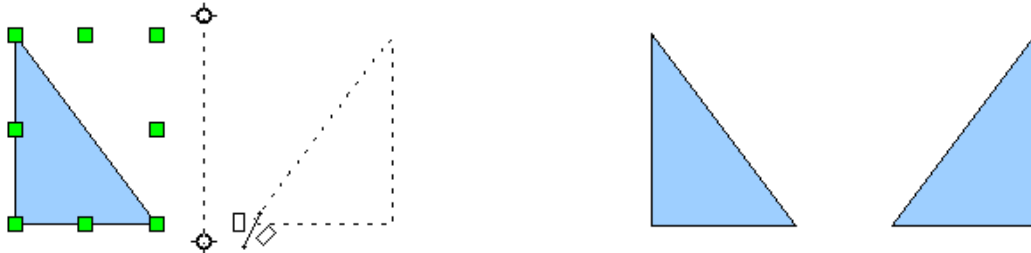

Distorting an image

There are three tools on the **Effects** menu that let you drag the corners and edges of an object to distort the image.

The **Distort** tool distorts an object in perspective, the **Set to Circle (slant)** and **Set in Circle (perspective)** tools both create a pseudo three-dimensional effect. See Chapter 4 of the *Draw Guide* for details.

Dynamic gradients

You can control transparency gradients in the same manner as color gradients. Both types of gradient can be used together. With a transparency gradient, the direction and degree of an object's fill color changes from opaque to transparent (in a regular gradient, the fill changes from one color to another, but the degree of transparency remains the same). See Chapter 4 of the *Draw Guide* for details.

Duplication

Duplication makes copies of an object while applying a set of changes (such as color or rotation) to the duplicates. The result of a duplication is a new group of objects.

To start duplication, click on an object or group and choose **Edit > Duplicate**. The dialog shown in Figure 172 appears.

The options chosen in Figure 172 applied to a blue rectangle produce the following result.

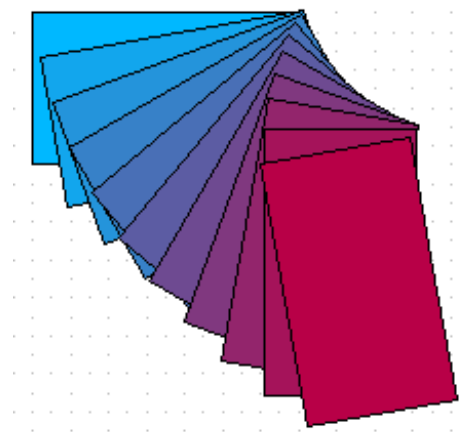

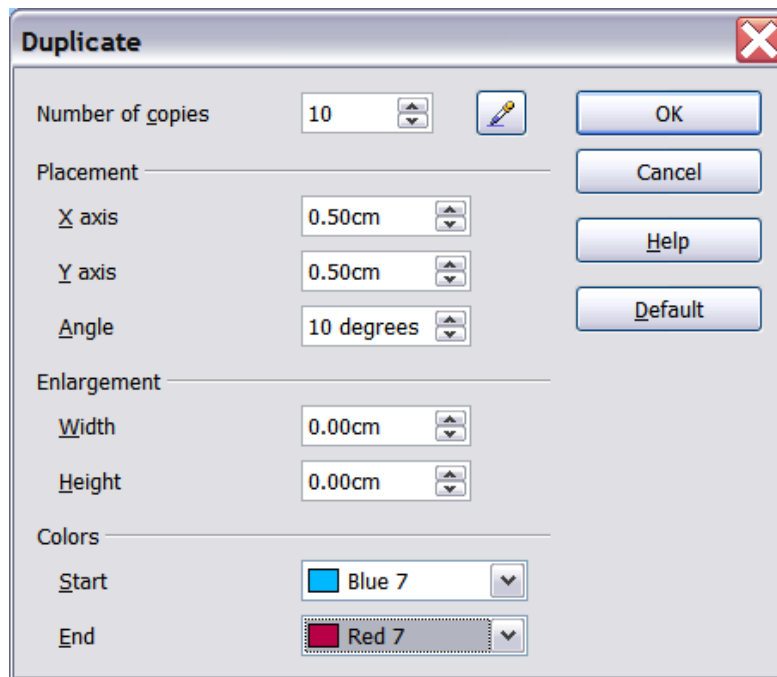

Figure 172: Duplicating an object

Cross-fading

Cross-fading transforms a shape from one form to another. The result is a new group of objects including the start and end points and the intermediate steps.

To carry out a cross-fade, first select two objects (hold the *Shift* key while selecting each object in turn) and then choose **Edit > Cross-fading**.

On the Cross-fading dialog, choose the number of increments (transition steps). You probably want to have *Cross-fade attributes* and *Same orientation* both checked. The end result is shown in Figure 174.

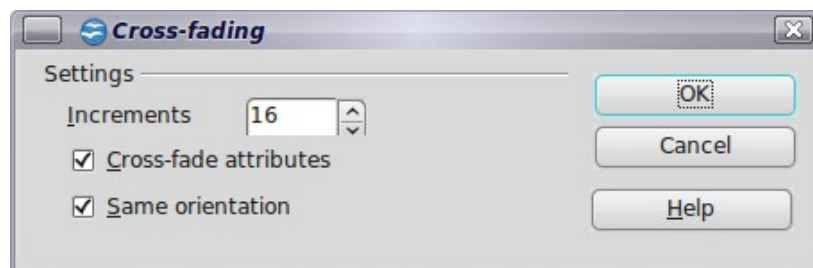

Figure 173: Choosing cross-fading settings

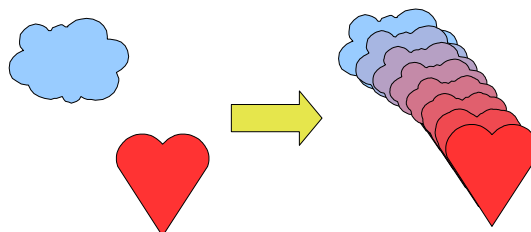

Figure 174: Cross-fading example

Combining multiple objects

Using Draw, you can combine drawing objects together in two distinct ways: *grouping* and *combining*. These two methods allow you to treat multiple objects as one unit, or to merge objects to form a new shape.

Grouping is like putting objects in a container. You can move them as a group and apply global changes to them. A group can always be undone and the objects that make up the group can always be manipulated separately.

A *combination* is a permanent fusion of objects leading to a new object. The original objects are no longer available as individual entities and the operation is not reversible.

Grouping by common selection

When several objects are selected, any operations you carry out are applied to all of the objects. For example, you can rotate a group of objects in its entirety. Groups obtained through common selection of several objects are undone as soon as you click outside the group. However, you can group objects and keep those selected objects grouped together.

Maintaining groups and undoing groups

To group objects, first select the objects, then right-click and choose **Group** from the pop-up menu. You can also use the keyboard shortcut *Control+Shift+G* or choose **Modify > Group** from the menu bar.

When objects are grouped, any editing operations carried out on that group are applied to all members of the group. If you click on one member of the group, the whole group is selected.

The objects of a group retain their own individual properties. To undo a group, right-click and choose **Ungroup** from the pop-up menu, use the keyboard shortcut *Control+Alt+Shift+G* or choose **Modify > Ungroup** from the menu bar.

You can edit a member of a group individually without breaking the group. To do this, right-click and choose **Enter group** or double-click on the group.

Combining objects

In contrast to grouping functions, *combinations* create a new object; subsequent “uncombining” in the same manner as ungrouping is not possible. Select a collection of objects, then right-click and choose **Combine** from the pop-up menu.

After you have selected more than one object, the Merge, Subtract, and Intersect functions can be reached in the **Modify > Shapes** menu or through the group’s right-click menu under the heading **Shapes**.

Aids for positioning objects

Draw has various tools to help you arrange the objects with respect to each other:

- Moving an object to the front or to the back
- Aligning objects with respect to each other
- Distributing the distance and space between objects

See Chapter 5 (Combining Multiple Objects) in the *Draw Guide* for more information.

Inserting and editing pictures

Draw contains a number of functions for editing raster graphics (bitmaps)—for example, photos and scanned images—including import and export as well as conversion from one format to another. Draw can read in all the usual range of graphic file formats.

You can add pictures from several sources:

- The Gallery—see Chapter 11 (Graphics, the Gallery, and Fontwork)
- Directly from a scanner (**Insert > Picture > Scan**)
- Images created by another program, including photographs from a digital camera (**Insert > Picture > From File**)

Draw provides tools for working with bitmap images: the Picture toolbar and the bitmap image management palette. However, it does not have the same capabilities as the specialized raster graphics programs like Adobe Photoshop or The Gimp. See Chapter 6 (Editing Pictures) in the *Draw Guide* for details and examples.

Working with 3D objects

Although Draw does not match the functionality of the leading drawing or picture editing programs, it is capable of producing and editing very good 3D drawings.

Draw offers two types of 3D objects: *3D bodies*, and *3D shapes*. Depending on which type you choose, there are different possibilities for further editing of the object (rotation, illumination, perspective). 3D shapes are simpler to set up and edit than 3D bodies, but 3D bodies currently allow for more customization.

See Chapter 7 (Working with 3D Objects) in the *Draw Guide* for details.

Exporting graphics

To save a Draw image in a format other than *.odg, use **File > Export**. Draw can save to many graphic file formats, as listed in Appendix B (Background Information) of this book. You can export the entire file or selected objects.

You can also export Draw files to HTML, PDF, or Flash. PDF export is the same as for any part of OpenOffice.org, as described in Chapter 10 (Printing, Exporting, and E-mailing) of this book. Flash export creates a .swf file.

HTML export uses a conversion wizard that creates as many web pages as there are pages in your Draw document. You can optionally choose to display the pages in frames with a navigator and can set an index page. For more information, see Chapter 12 (Creating Web Pages: Saving Documents as HTML Files) of this book.

Adding comments to a drawing

Starting with OOo 3.2, Draw supports comments (formerly called notes) similar to those in Writer and Calc.

Choose **Insert > Comment** from the menu bar. A small box containing your initials appears in the upper left-hand corner of the Draw page, with a larger text box beside it. Draw has automatically added your name and the date at the bottom of this text box.

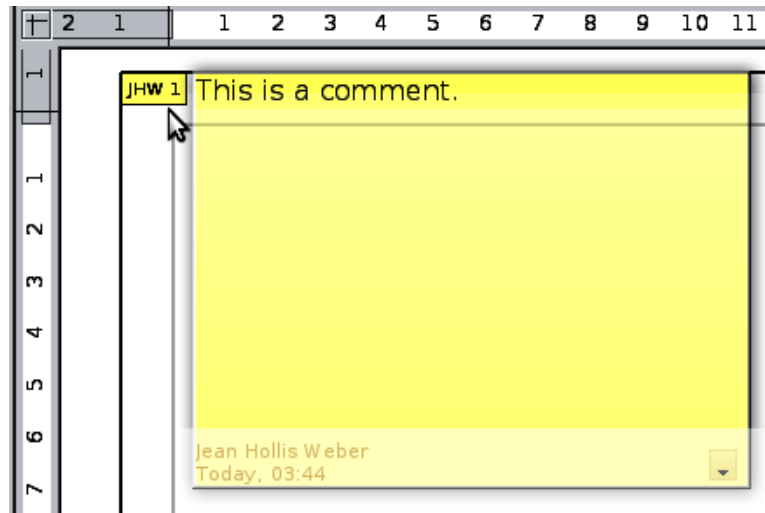

Type or paste your comment into the text box. You can optionally apply some basic formatting to parts of the text by selecting it, right-clicking, and choosing from the pop-up menu. From this menu, you can also delete the current comment, all the comments from the same author, or all the comments in the document.

You can move the small comment markers to anywhere you wish on the page. Typically you might place it on or near an object you refer to in the comment.

To show or hide the comment markers, choose **View > Comments**.

Choose **Tools > Options > User Data** to enter the name you want to appear in the Author field of the comment.

If more than one person edits the document, each author is automatically allocated a different background color.

Chapter 8

Getting Started with Base

OpenOffice.org's Database Component

Introduction

A data source, or database, is a collection of pieces of information that can be accessed or managed by OpenOffice.org (OOo). For example, a list of names and addresses is a data source that could be used for producing a mail merge letter. A shop stock list could be a data source managed through OOo.

Note OpenOffice.org uses the terms “Data Source” and “Database” to refer to the same thing, which could be a database such as MySQL or dBase or a spreadsheet or text document holding data.

This chapter covers creating a database, showing what is contained in a database and how the different parts are used by OOo. It also covers using the Base component of OOo to register other data sources. A data source can be a database, spreadsheet, or text document.

Note OOo Base uses the HSQL database engine. All of the files created by this engine are kept in one zipped file. The database forms are included in this zipped file.

A *database* consists of a number of *fields* that contain the individual pieces of data. Each *table* of the database is a group of fields. When creating a table, you also determine the characteristics of each field in the table. *Forms* are for data entry into the fields of one or more tables associated with the form. They can also be used for viewing fields from one or more tables associated with the form. A *query* creates a new table from the existing tables based upon how you create the query. A *report* organizes the information of the fields of a query in a document according to your requirements.

Caution



The database in OOo requires Java Runtime Environment (JRE). If you do not have it on your computer, you can download it from www.java.com and install it following the instructions on the site. It should be Java 5.0 or higher. In OOo, use **Tools > Options > OpenOffice.org > Java** to register Java.

Windows' version of JRE can **not** be used, while there are other versions that can.

Base creates *relational databases*. This makes it fairly easy to create a database in which the fields of the database have relationships with each other.

For example: Consider a database for a library. It will contain a field for the names of the authors and another field for the names of the books. There is an obvious relationship between the authors and the books they have written. The library may contain more than one book by the same author. This is what is known as a one-to-many relationship: one author and more than one book. Most if not all the relationships in such a database are one-to-many relationships.

Consider an employment database for the same library. One of the fields contains the names of the employees while others contain the social security numbers, and other personal data. The relationship between the names and social security numbers is one-to-one: only one social security number for each name.

If you are acquainted with mathematical sets, a relational database can easily be explained in terms of sets: elements, subsets, unions, and intersections. The fields of

a database are the elements. The tables are subsets. Relationships are defined in terms of unions and intersections of the subsets (tables).

To explain how to use a database, we will create one for automobile expenses. In the process, we will be explaining how a database works.

Planning a database

The first step in creating a database is to ask yourself many questions. Write them down, and leave some space between the questions to later write the answers. At least some of the answers should seem obvious after you take some time to think.

You may have to go through this process a few times before everything becomes clear in your mind and on paper. Using a text document for these questions and answers makes it easier to move the questions around, add additional questions, or change the answers.

Here are some of the questions and answers I developed before I created a database for automobile expenses. I had an idea of what I wanted before I started, but as I began asking questions and listing the answers, I discovered that I needed additional tables and fields.

What are the fields going to be? My expenses divided into three broad areas: fuel purchases, maintenance, and vacations. The annual cost for the car's license plate and driver's license every four years did not fit into any of these. It will be a table of its own: license fees.

What fields fit the fuel purchases area? Date purchased, odometer reading, fuel cost, fuel quantity, and payment method fit. (Fuel economy can be calculated with a query.)

What fields fit the maintenance area? Date of service, odometer reading, type of service, cost of service, and next scheduled service of this type (for example, for oil changes list when the next oil change should be). But it would be nice if there was a way to write notes. So, a field for notes was added to the list.

What fields fit the vacations area? Date, odometer reading, fuel (including all the fields of the fuel table), food (including meals and snacks), motel, total tolls, and miscellaneous. Since these purchases are made by one of two bank cards or with cash, I want a field to state which payment type was used for each item.

What fields fit into the food category? Breakfast, lunch, supper, and snacks seem to fit. Do I list all the snacks individually or list the total cost for snacks for the day? I chose to divide snacks into two fields: number of snacks and total cost of snacks. I also need a payment type for each of these: breakfast, lunch, supper, and total cost of snacks.

What are the fields that are common to more than one area? Date appears in all of the areas as does odometer reading and payment type.

How will I use this information about these three fields? While on vacation, I want the expenses for each day to be listed together. The date fields suggest a relationship between the vacation table and the dates in each of these tables: fuel and food. This means that the date fields in these tables will be linked as we create the database.

The type of payment includes two bank cards and cash. So, we will create a table with a field for the type of payment and use it in list boxes in the forms.

Tip

While we have listed fields we will create in the tables of the database, there is one more field that may be needed in a table: the field for the primary key. In some tables, the field for the primary key has already been listed. In other tables such as the payment type, an additional field for the primary key must be created.

Creating a new database

To create a new database, choose **File > New > Database** from the menu bar, or click the arrow next to the **New** icon on the Standard toolbar and select **Database** from the dropdown menu. Both methods open the Database Wizard.

On the first page of the Database Wizard, select **Create a new database** and then click **Next**.

The second page has two questions. Make sure the choice for the first question is **Yes, register the database for me** and the choice for the second question is **Open the database for editing**. Click **Finish**.

Note

If the database is not registered, it will not be accessible to the other OOo components such as Writer and Calc. If the database is registered, other components can access it.

Save the new database with the name *Automobile*. This opens the Automobile - OpenOffice.org Base window. Figure 175 shows part of this window.

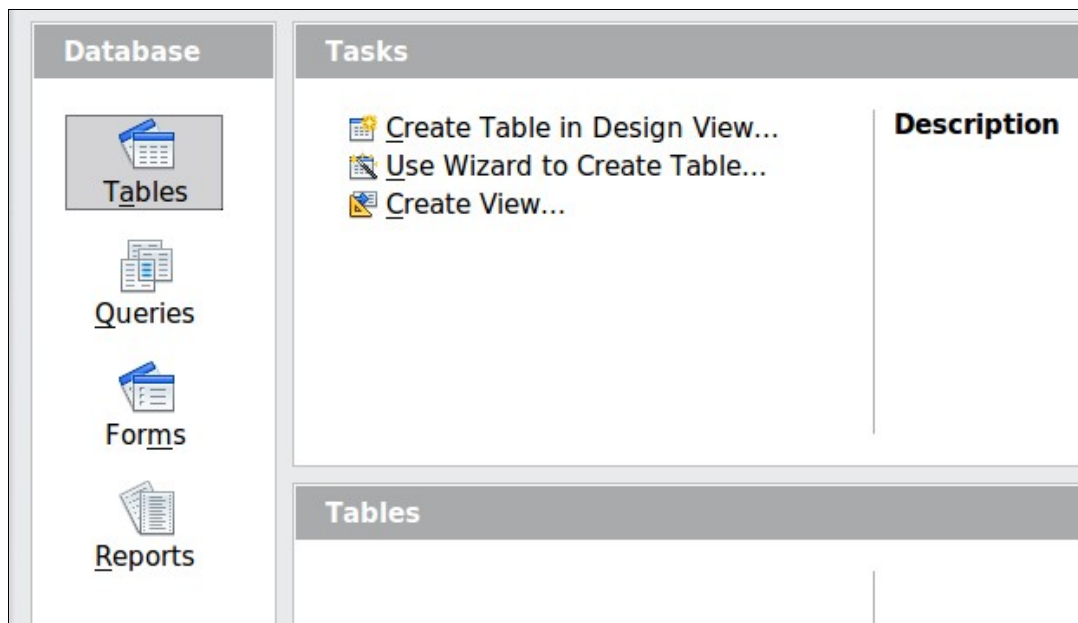

Figure 175: Creating database tables

Tip

Every time the *Automobile* database is opened, the Automobile - OpenOffice.org Base window opens. Changes can then be made to the database. The title for this window is always <database name> - OpenOffice.org Base.

Caution

As you create a database, you should save your work regularly. This means more than just saving what you have just created. You must save the whole database as well.

For example, when you create your first table, you must save it before you can close it. When the table is first saved, it is also made part of the database.

Creating database tables

In a database, a table stores information for a group of things we call fields. For example, a table might hold an address book, a stock list, a phone book or a price list. A database can have from one to several tables.

To work with tables, click the *Tables* icon in the *Database* list, or press *Alt+a*. The three tasks that you can perform on a table are in the *Tasks* list (see Figure 175).

Using the Wizard to create a table

Wizards are designed to do the basic work. Sometimes this is not sufficient for what we want; in those cases we can use a wizard as a starting point and then build upon what it produces.

The Table Wizard in Base contains two categories of suggested tables: business and personal. Each category contains sample tables from which to choose. Each table has a list of available fields. We can delete some of these fields and add other fields.

A field in a table is one bit of information. For example, a price list table might have one field for item name, one for the description, and a third for the price.

Since none of the fields we need for our Automobile database are contained in any of the sample wizard tables, we will create a simple table using the wizard that has nothing to do with our database. This section is an exercise in explaining how the Wizard works.

The Wizard permits the fields of the table to come from more than one suggested table. We will create a table with fields from three different suggested tables in the Wizard.

Caution

Every table requires a *Primary key field*. (What this field does will be explained later.) We will use this field to number our entries and want that number to automatically increase as we add each entry.

Click *Use Wizard to Create Table*. This opens the Table Wizard (Figure 176).

Step 1: Select fields.

We will use the *CD-Collection* Sample table in the Personal category to select the fields we need.

- 1) *Category*: Select *Personal*. The *Sample Tables* dropdown list changes to a list of personal sample tables.
- 2) *Sample tables*: Select *CD-Collection*. The *Available fields* box changes to a list of available fields for this table.

- 3) *Selected fields*: Using the > button, move the following fields from the *Available fields* window to the *Selected fields* window in this order: *CollectionID*, *AlbumTitle*, *Artist*, *DatePurchased*, *Format*, *Notes*, and *NumberofTracks*.
- 4) *Selected Fields from another sample* table. Click *Business* as the *Category*. Select *Employees* from the dropdown list of sample tables. Use the > button to move the *Photo* field from the *Available fields* window to the *Selected fields* window. It will be at the bottom of the list directly below the *NumberofTracks* field.
- 5) If you make a mistake in selecting fields, click on the field name in the *Selected fields* list and use the < button to move it from the *Selected fields* list back to the *Available fields* list.
- 6) If you make a mistake in the order of the selected fields, click on the field name that is in the wrong order and use the **Up** or **Down** arrow on the right side of the *Selected fields* list to move the field name to the correct position.
- 7) Click **Next**.

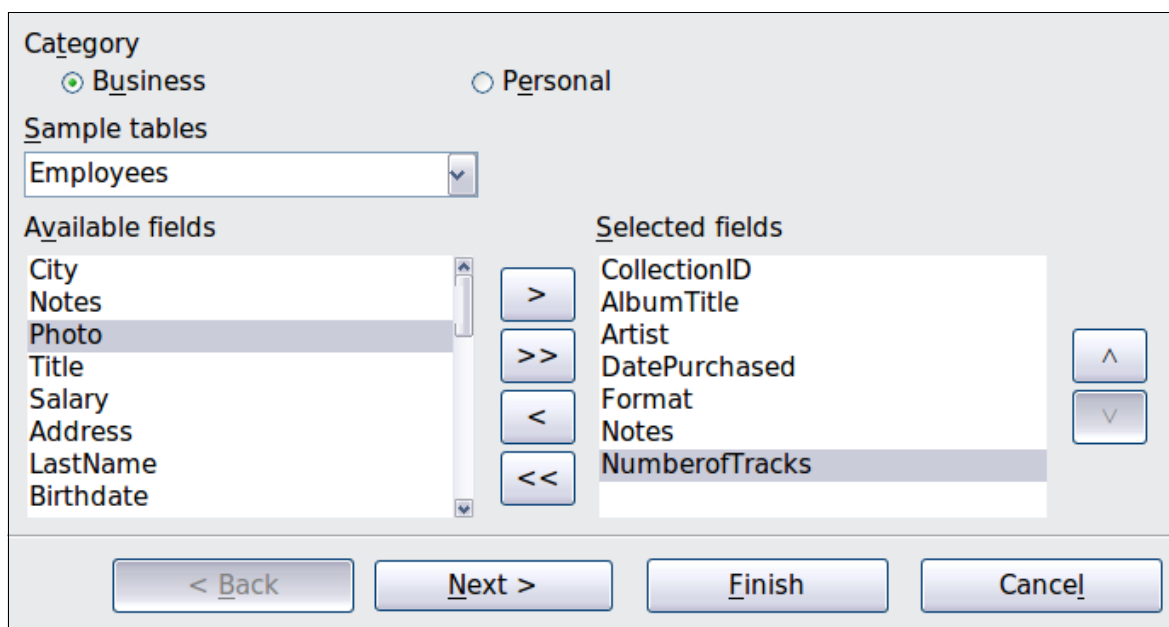

Figure 176: Selecting fields for the table

Step 2: Set field types and formats.

In this step you give the fields their properties. When you click a field, the information on the right changes. (See Figure 177.) You can then make changes to meet your needs. Click each field, one at a time, and make the changes listed below.

Selected fields	Field information	
CollectionID	Field name	CollectionID
AlbumTitle	Field type	Integer [INTEGf
Artist	AutoValue	No
DatePurchased	Entry required	No
Format	Length	10
Notes		
NumberofTracks		
Photo		

Figure 177: Changing field types

Note

If any of these fields requires an entry, set *Entry required* to **Yes**. An entry with that field blank will then not be allowed. In general, only set *Entry required* to **Yes** if something must always be put in that field. By default, *Entry required* is set to **No**.

-
- *CollectionID*: Change *AutoValue* from **No** to **Yes**.
 - *AlbumTitle*:
 - *Entry required*: Leave *Entry required* as *No*, unless all of your music is in albums.
 - *Length*: Unless you have an album title that exceeds 100 characters counting the spaces, do not change the length.

Note

In Base the maximum length of each field must be specified on creation. It is not easy to change this later, so if in doubt specify a greater length. Base uses VCHAR as the field format for text fields. This format only uses the actual number of characters in a field up to the limit set. So, a field containing 20 characters will only use space for 20 characters even if the limit is set at 100. Two album titles containing 25 and 32 characters respectively will use space for 25 and 32 characters and not 100 characters.

-
- *Artist*: Use the Default setting. And since music has artists, set *Entry Required* to *Yes*.
 - *Date Purchased*: *Field type*: default date setting. *Entry required* should be *No*. (You may not know the date.)
 - *Format*: Only change the *Entry Required* setting: from *No* to *Yes*.
 - *Notes*: No changes are required.
 - *NumberofTracks*: Change the *Field Type* to *Tiny Integer [TINYINT]*. Your allowable number of tracks will be 999. *Small Integer [SMALLINT]* would allow 99999 tracks if you needed more than 999 tracks.
 - *Photo*: Use the default settings.

When you have finished, click **Next**.

Note

Each field has a *Field Type*, which must be specified. Types include text, integer, date, and decimal. If the field is going to have general information in it (for example, a name or a description), use text. If the field will always contain a number (for example, a price), the type should be decimal or another numerical field. The wizard picks the right field type, so to get an idea of how this works, see what the wizard has chosen for different fields.

Step 3: Set primary key.

- 1) *Create a primary key* should be checked.
 - 2) Select option *Use an existing field as a primary key*.
 - 3) In the *Fieldname* dropdown list, select *CollectionID*.
 - 4) Check *Auto value* if it is not already checked.
 - 5) Click **Next**.
-

A primary key uniquely identifies an item (or record) in the table. For example, you might know two people called “Randy Herring” or three people living at the same address and the database needs to distinguish between them.

Note

The simplest method is to assign a unique number to each one: number the first person 1, the second 2, and so on. Each entry has one number and every number is different, so it is easy to say “record ID 172”. This is the option chosen here: *CollectionID* is just a number assigned automatically by Base to each record of this table.

Step 4: Create the table.

- 1) If desired, rename the table at this point. If you rename it, make the name meaningful to you. For this example, make no changes.
- 2) Leave the option *Insert data immediately* checked.
- 3) Click **Finish** to complete the table wizard. Close the window created by the table wizard. You are now back to the main window of the database with the listing of the tables, queries, forms, and reports. Notice that a table named “CD-Collection” is now listed in the Tables portion of the window.

Creating a table by copying an existing table

If you have a large collection of music, you might want to create a table for each type of music you have. Rather than creating each table from the wizard, you can make copies of the original table, naming each according to the type of music contained in it.

- 1) Click on the **Tables** icon in the Database pane to see the existing tables.
- 2) Right-click on the *CD-Collection* table icon. Choose **Copy** from the pop-up menu.
- 3) Move the mouse pointer below this table, right-click, and select **Paste**. The Copy table dialog opens.
- 4) Change the table name to *Pop* and click **Next**.
- 5) Click the >> button to move all the fields from the left box to the right box and click **Next**.
- 6) Since all the fields already have the proper Field type, no changes should be needed. However, this is the time and place to make any changes if they are

needed. (See Caution below for the reason why.) Click **Create**. The new table is created.

Caution

Once tables have been created using the wizard and data has been entered, editing them should be very limited. Fields can be added or deleted, but adding a field requires taking the time to enter the data for that one field for every record having an entry for that field.

Deleting a field deletes **all the data** once contained in that field. Changing the field type of a field can lead to data being lost either partially or completely. When creating a new table, it pays to create the fields with the correct names, length, and format before you add any data.

Deleting a table removes all of the data contained in every field of the table. Unless you are sure, do not delete a table.

Creating tables in Design View

Design View is a more advanced method for creating a new table, in which you directly enter information about each field in the table. We will use this method for the tables of our database.

Note

While the *Field type* and *formatting* are different in *Design View*, the concepts are the same as in the Wizard.

The first table to be created is *Fuel*. Its fields are *FuelID*, *Date*, *FuelCost*, *FuelQuantity*, *Odometer*, and *PaymentType*.

- 1) Click Create Table in Design View.
 - 2) *FuelID* field:
 - a) Type *FuelID* as the first Field Name. Press the *Tab* key to move to the Field Type column.
 - b) Select *Integer [INTEGER]* as the Field Type from the dropdown list. (The default setting is Text [VARCHAR].)
-

Tip

A shortcut for selecting from the Field Type dropdown list: press the key for the first letter of the choice. You can cycle through the choices for a given letter by repeatedly pressing that key.

- c) Change the Field Properties in the bottom section. Change *AutoValue* from *No* to *Yes*.
- d) Set *FuelID* as the *Primary key*.
Right-click on the green triangle to the left of *FuelID* (Figure 178) and choose *Primary Key* from the menu. This places a key icon in front of *FuelID*.

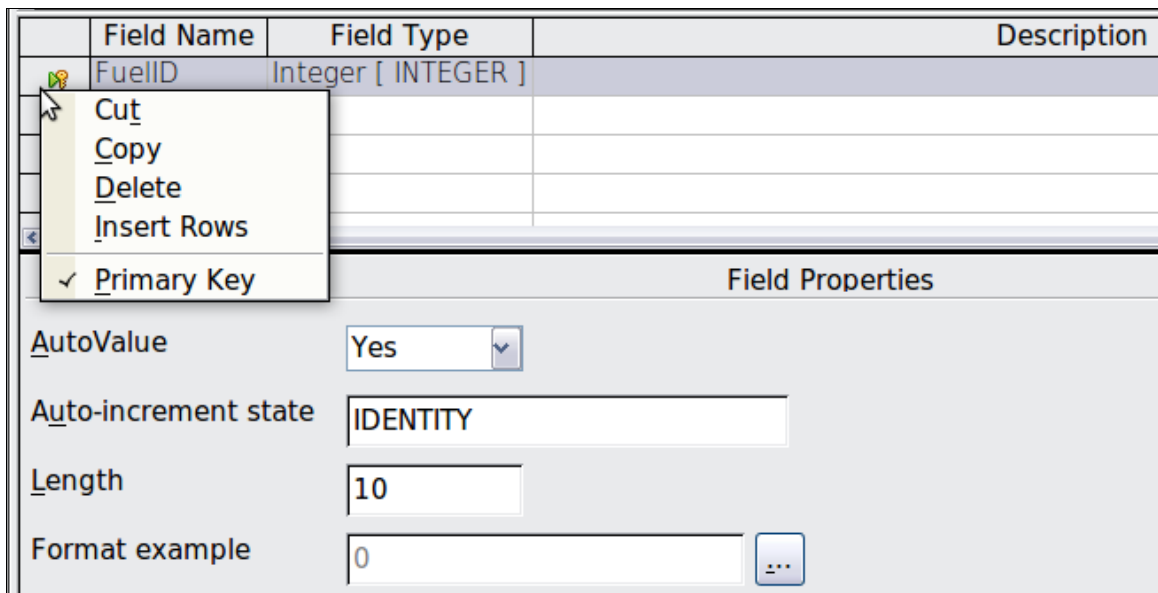

Figure 178: Defining the primary key field

Note

The primary key serves only one purpose: to uniquely identify the record. Any name can be used for this field. We have used *FuelID* for convenience, so we know to which table it belongs.

- 3) All other fields (*Date*, *FuelCost*, *FuelQuantity*, *Odometer*, and *PaymentType*):
- Type the next field name in the Field Name column.
 - Select the Field Type for each field.
 - For *Date* use Date[DATE]. (Press the *D* key to select it.)
 - *PaymentType* uses Text [VARCHAR], the default setting.
 - All other fields use Number [NUMERIC]. (Press the *N* key once to select it.)
 - *FuelCost*, *FuelQuantity*, and *Odometer* need changes in the Field Properties section (Figure 179).
 - *FuelQuantity*: Change *Length* to 6 and *Decimal places* to 3. (Many fuel pumps measure fuel to thousands of a gallon in the USA where I live.)
 - *Odometer*: Change the *Length* to 10 and the *Decimal places* to 1.
 - *FuelCost*: Change the *Length* to 5 and *Decimal places* to 2. Click the *Format example* button. This opens the Field Format window (Figure 180). Use *Currency* as the Category and your currency as the Format. My currency has two decimal places. Use what is appropriate for yours.

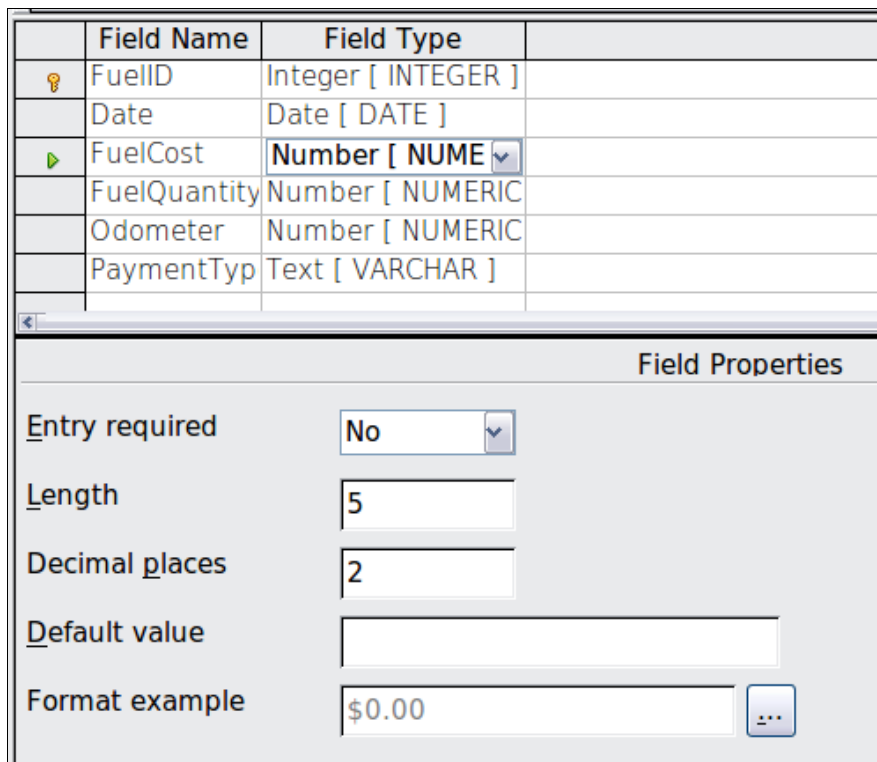

Figure 179: Changing field properties

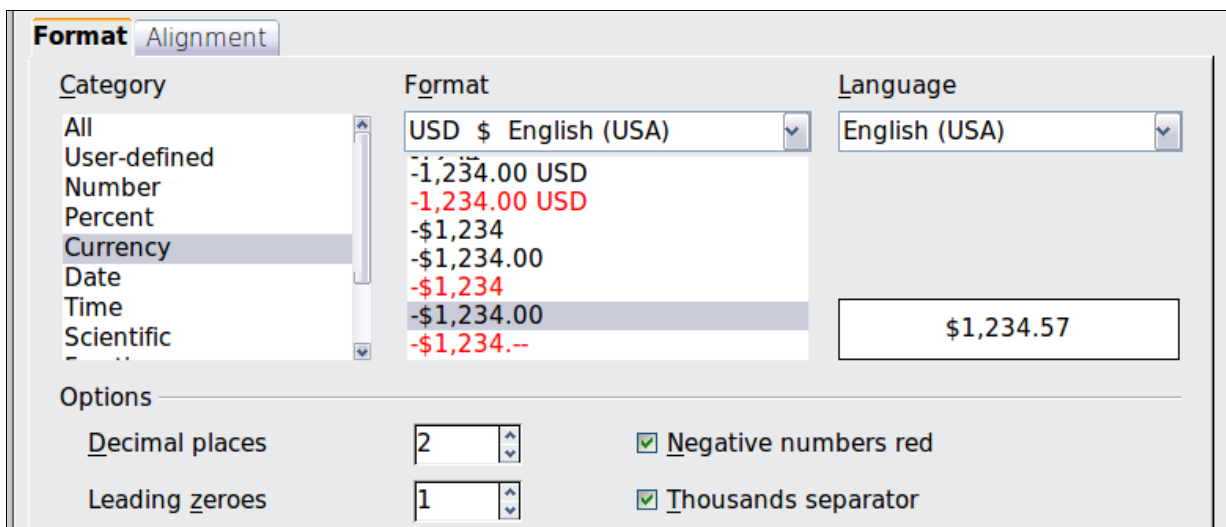

Figure 180: Field Format options

- 4) To access additional formatting options, click the button to the right of the Format example field.
- 5) *Description* can be anything, or can be left blank.
- 6) To save and close the table, choose **File > Save**. Name the table *Fuel*. Close the Fuel table.

Follow the same steps to create the *Vacations* table. The fields and their field types are listed in Figure 181. Make sure you make the Date field the primary key before closing. (Right-click the gray box to the left of Date and select **Primary key** from the menu.) Save the table and name it *Vacations*. Close the Vacations table.

	Field Name	Field Type	
?	Date	Date [DATE]	
	Odometer	Number [NUMERIC]	Odometer reading
	Motel	Number [NUMERIC]	
	Tolls	Number [NUMERIC]	total tolls
	Breakfast	Number [NUMERIC]	
	BPayment	Text [VARCHAR]	payment type
	Lunch	Number [NUMERIC]	
	LPayment	Text [VARCHAR]	payment type
	Supper	Number [NUMERIC]	
	SPayment	Text [VARCHAR]	payment type
	SnackNo	Number [NUMERIC]	
	SnackCost	Number [NUMERIC]	
	SnPayment	Text [VARCHAR]	payment type for snacks
▶	Miscellaneous	Number [NUMERIC]	misc. costs
	MPayment	Text [VARCHAR]	payment type for motel
	MiscNotes	Memo [LONGVARCHAR]	
	MiscPayment	Text [VARCHAR]	payment type for miscellaneous

Figure 181: Fields in Vacations table

Creating tables for the list box

When the same information can be used in several fields, design a table for each type of information. Each table will contain two fields: the information field and *ID*, in that order.

Caution



You **must create** these tables with the information field listed **first** and the ID field listed **last**. Failure to do so will produce the wrong results.

For my Payment table, I use Name and ID as my fields, with *Dan*, *Kevin*, and *Cash* being the Name entries. The corresponding ID entries are *0*, *1*, *2*. When the Name field is listed first in the table, one of the three names will appear in the payment field of the Fuel table. If the ID field is listed first, *0*, *1*, or *2* appear in the payment field instead.

- 1) Follow the directions in “Creating tables in Design View” on page 209. In the table, the two fields can be *Type* and *PaymentID*. In the Field Properties, set *AutoValue* to **Yes** for the *PaymentID* field. Set the *PaymentID* field as the primary key. (See Figure 182.)
- 2) Save the table using the name *Payment Type*.

	Field Name	Field Type
▶	Type	Text [VARCHAR]
?	PaymentID	Integer [INTEGER]

Figure 182: Table in Design View

Note

If you have several tables to create with the same fields, design one table and produce the other tables by cutting and pasting. (See “Creating a table by copying an existing table” on page 208.)

Adding data to the list table

List tables do not require a form. Instead, add their data directly to the table. In this example, use the names of the two people with a bank card and Cash for cash purchases.

- 1) In the main database window, click on the *Tables* icon (Figure 175). In the list of tables, right-click on *Payment Type* and select **Open** from the pop-up menu.
 - a) Enter *Dan* in the Type column in the first row. Press the *Tab* key to move to the second row. Notice that the PaymentID value for this row changes from <AutoField> to 0.
 - b) Enter *Kevin* in the second row. The PaymentID changes to 1.
 - c) Enter *Cash* in the third row. The PaymentID changes to 2.
- 2) Save and close the table window.

Tip

You can also use the *Enter* key to move from entry field to entry field, or use the *down arrow* key to move from row to row.

Defining relationships

Now that the tables have been created, what are the relationships between our tables? This is the time to define them based upon the questions we asked and answered in the beginning.

When on vacation, we want to enter all of our expenses all at one time each day. Most of these expenses are in the Vacations table, but the fuel we buy is not. So, we will relate these two tables using the Date fields. Since the Fuel table may have more than one entry per date, this relationship between the Vacations and Fuel tables is one to many. (It is designated 1:n.)

The Vacations table also contains several fields for the type of payment used. For each field listing the payment type, there is only one entry from the Payment Type table. This is a one to one relationship: one field in one table to one entry from the other table. (It is designated 1:1.) Other tables also contain fields for the type of payment. The relationship between the fields of those tables and the Payment Type table are also 1:1.

Since the Payment Type table only provides a static list, we will not be defining a relationship between the Payment Type table and the fields of the other tables which use the entries of the Payment Type table. That will be done when the forms are created.

The Fuel and Maintenance tables do not really have a relationship even though they share similar fields: Date and Odometer.

Tip

As you create your own databases, you need to also determine where tables are related and how.

- 1) To begin defining relationships, choose **Tools > Relationships**. The Automobile - OpenOffice.org Base: Relation Design window opens and the Add Tables dialog pops up. (You can also open it by clicking the Add Tables icon on the Relation Design window.)
- 2) On the Add Tables dialog, use either of these ways to add a table to the Relation Design window:

- Double-click the name of the table. In our case, do this for both *Vacations* and *Fuel*.
 - Or, click the name of the table and then click **Add** for each table.
- 3) Click **Close** to close the Add Tables dialog when you have added the tables you want.
- 4) You can define the relationship between the *Vacations* and *Fuel* tables in two ways:
- Click and drag the *Date* field in the *Fuel* table to the *Date* field in the *Vacations* table. When you release the mouse button, a connecting line forms between the two date fields (Figure 183).

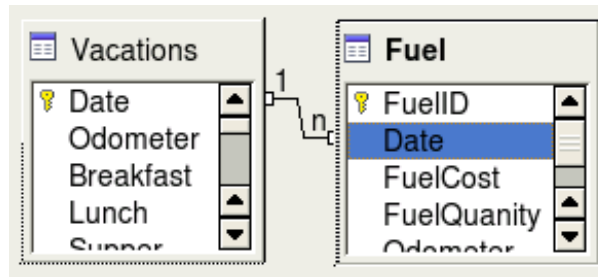

Figure 183: Designation for a 1:n relationship

- Or, click the **New Relation** icon. This opens the Relations window (Figure 184). Our two tables are listed in the *Tables involved* section.
 - In the *Fields involved* section, click the dropdown list under the *Fuel* label.
 - Select *Date* from the *Fuel* table list.
 - Click in the cell to the right of this dropdown list. This opens a dropdown list for the *Vacations* table.
 - Select *Date* from the *Vacations* table list. It should now look like Figure 184.
 - Click **OK**.

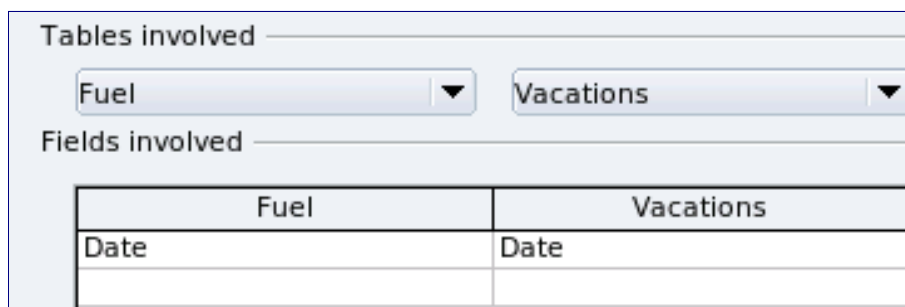

Figure 184: Selected fields in a relationship

- 5) Modifying the *Update options* and *Delete options* section of the Relation window.
- Right-click the line connecting the *Date* fields in the two table lists to open a menu.
 - Select **Edit** to open the Relations dialog (Figure 185).
 - Select **Update cascade**.
 - Select **Delete cascade**.

- e) Click **OK** to close the Relations dialog and choose **File > Save** to save the Relation Design window.

While these options are not strictly necessary, they do help. Having them selected permits you to update a table that has a relationship defined with another table. It also permits you to delete a field from the table.

Update options	Delete options
<input type="radio"/> No action	<input type="radio"/> No action
<input checked="" type="radio"/> Update cascade	<input checked="" type="radio"/> Delete cascade
<input type="radio"/> Set null	<input type="radio"/> Set null
<input type="radio"/> Set default	<input type="radio"/> Set default

OK Cancel Help

Figure 185: Update options and Delete options section

Creating a database form

Databases are used to store data. But, how is the data put into the database? Forms are used to do this. In the language of databases, a form is a front end for data entry and editing.

FuelID	Date
0	Thursday, April 12, 2007
FuelCost	FuelQuantity
\$26.45	11.650
Odometer	PaymentType
90997.9	Kevin

Figure 186: Fields of a simple form

Fuel Purchases	
FuelID	Date
0	Thursday, April 12, 2007
FuelCost	FuelQuantity
\$26.45	11.650
Odometer	PaymentType
90997.9	Kevin

Figure 187: Simple form with additions

A simple form consists of the fields from a table (Figure 186). More complex forms can contain much more, including additional text, graphics, selection boxes, and many other elements. Figure 187 is made from the same table with a text label (Fuel Purchases), a list box placed in PaymentType, and a graphic background.

Using the Wizard to create a form

We will use the Form Wizard to create a Vacations form, which will contain a form and a subform.

In the main database window (Figure 175), click the **Forms** icon in the left column. In the Tasks list, double-click **Use Wizard to Create Form** to open the Form Wizard (Figure 188). Simple forms require only some of these steps, while more complex forms may use all of them.

Step 1: Select fields.

- 1) Under Tables or queries, select Table: Vacations. *Available fields* lists the fields for the Vacations table.
- 2) Click the right double arrow to move all of these fields to the *Fields in the form* list. Click **Next**.

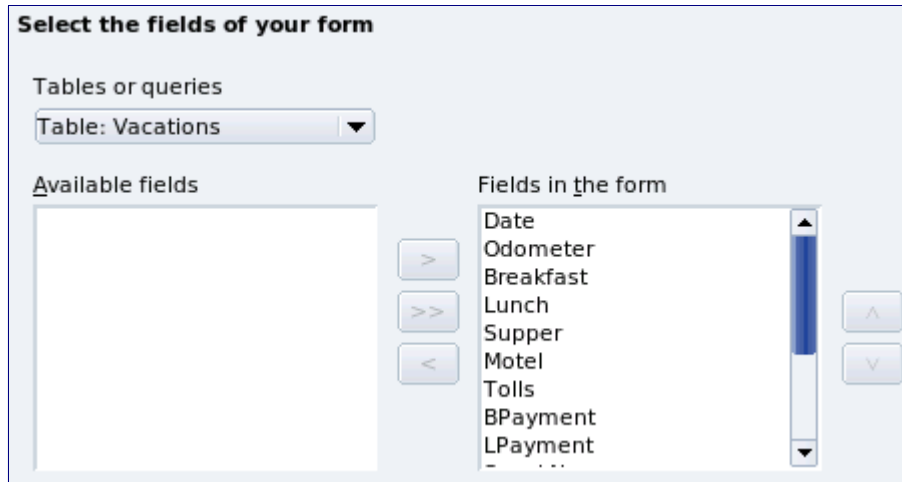

Figure 188: Form Wizard steps

Step 2: Set up a subform.

Since we have already created a relationship between the Fuel and Vacations tables, we will use that relationship. If no relationship had been defined, this would be done in step 4.

- 1) Click the box labeled *Add Subform*.
- 2) Click *Subform based upon existing relation*.
- 3) Fuel is listed as a relation we want to add. So, click Fuel to highlight it, as in Figure 189. Click **Next**.

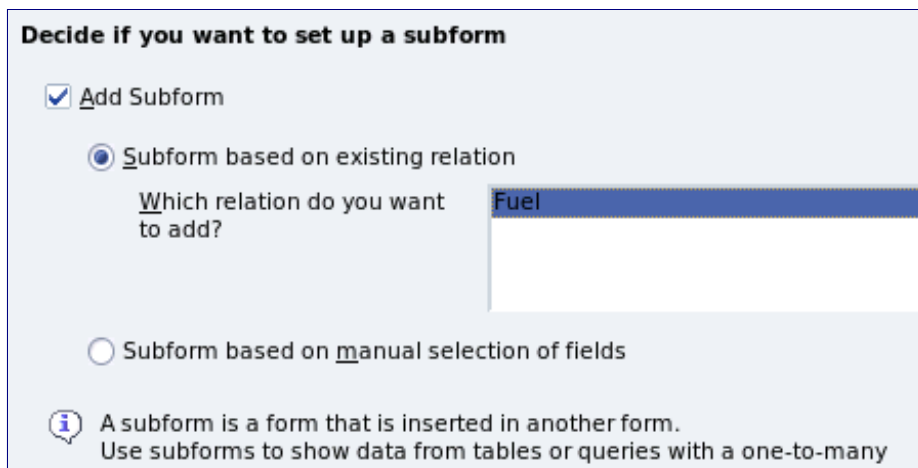

Figure 189: Adding a subform

Step 3: Add subform fields.

This step is exactly the same as step 1. The only difference is that not all of the fields will be used in the subform.

- 1) Fuel is preselected under *Tables or queries*.
- 2) Use the >> button to move all the fields to the right.
- 3) Click the FuelID field to highlight it.
- 4) Use the < button to move the FuelID to the left.
- 5) Click **Next**.

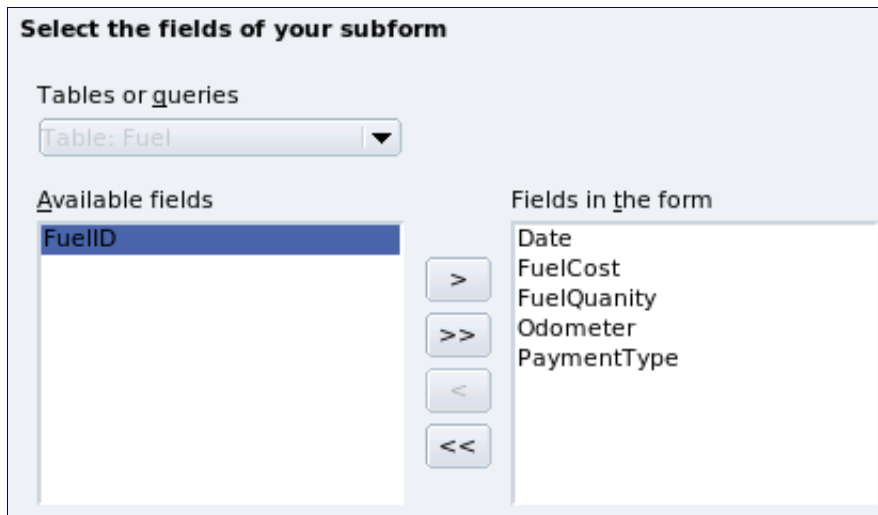

Figure 190: Selecting fields of a subform

Step 4: Get joined fields.

This step is for tables or queries for which no relationship has been defined. Because we have already defined the relationship, the wizard skips this step.

Note

It is possible to create a relationship between two tables that is based upon more than one pair of fields. How to do that and why is discussed in the *Base Guide*.

Caution



When selecting a pair of fields from two tables to use as a relationship, they have to have the same field type. That is why we used the Date field from both tables: both their field types are Date[DATE].

Whether a single pair of fields from two tables are chosen as the relationship or two or more pairs are chosen, certain requirements must be met for the form to work.

- No field from the subform can be the Primary key for its table. (FuelID cannot be used.)
 - Each pair of joined fields must have the same file type.
 - One of the fields from the main form must be the Primary key for its table. (Date would have to be used.)
-

Step 5: Arrange controls.

Each control in a form consists of two parts: label and field. This step in creating the form determines where a control's label and field are placed in relationship with each other. The four choices from left to right are *Columnar left*, *Columnar - Labels on top*, *As Data Sheet*, and *In Blocks - Labels Above*.

- 1) Arrangement of the main form: Click the second icon (*Columnar - Labels on top*). The labels will be placed above their field.
- 2) Arrangement of the subform: Click the third icon (*As Data Sheet*). (The labels are column headings and the field entries are in spreadsheet format.) Click **Next**.

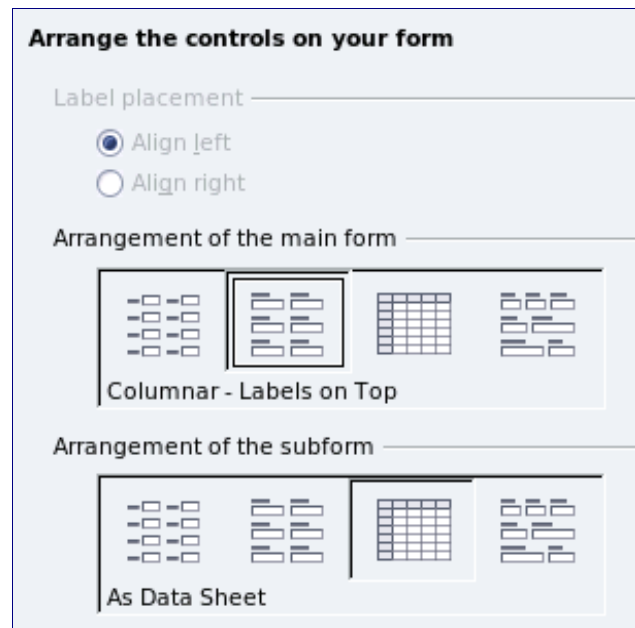

Step 6: Set data entry.

Unless you have a need for any of these entries to be checked, accept the default settings. Click **Next**.

Step 7: Apply styles.

- 1) Select the color you want in the *Apply Styles* list. (I chose the beige which is Orange 4 in the Color table.)
- 2) Select the Field border you want. (I prefer the 3-D look. You might want to experiment with the different possible settings.)
- 3) Click **Next**.

Step 8: Set name.

- 1) Enter the name for the form. In this case, it is *Fuel*.
- 2) Click *Modify the form*.
- 3) Click **Finish**. The form opens in Edit mode.

Modifying a form

We will be moving the controls to different places in the form and changing the background to a picture. We will also modify the label for the PaymentType field as well as change the field to a list box.

First, we must decide what we want to change. The discussion will follow this ten step outline of our planned changes.

- 1) Provide a dropdown capability for the Date field in the main form, and lengthen the field to show the day of the week, month, day, and year.
- 2) Shorten the length of the payment fields (all fields containing the word Payment).
- 3) Move the controls into groups: food, fuel subform, and miscellaneous.

- 4) Change the wording of some of the labels. Some single words should be two words. Some abbreviations should be used if possible (Misc. for miscellaneous).
- 5) Change the lengths of several fields and labels. Only Lunch, Supper, Motel, and Tolls have acceptable lengths. But for a better appearance, changes will be made to these as well.
- 6) Replace all the fields whose label ends in *Payment* with a list box containing the entries from the Payment Type table.
- 7) Lengthen the Note field vertically, add a scroll bar, and move it.
- 8) Make changes in the Date and PaymentType columns of the subform that are similar to the changes in the main form.
- 9) Add headings for each group in the main form.
- 10) Change the background to a picture, then modify some of the labels so that they can be read clearly. Change the font color of the headings.

Here are some methods that we will be using in these steps. The controls in the main form consists of a label and its field. Sometimes we want to work with the entire control, other times we want to work with only the label or the field, and there are times when we want to work with a group of controls.

- Clicking a label or field selects the entire control. A border appears around the control with eight green handles. You can then drag and drop it where you want.

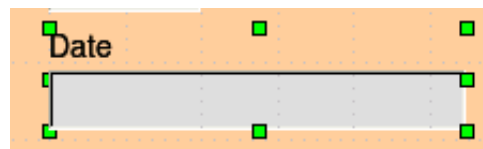

Figure 191: A selected control

- *Control+click* a label or field selects only the label or the field. You can press the *Tab* key to change the selection from the field to the label or the label to the field.

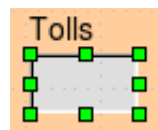

Figure 192: Selecting a field of a control

- Moving a group of controls is almost as easy as moving one of them.
 - 1) Click the field of the top left control to be moved, to select it.
 - 2) Move the cursor to just above and to the left of the selected control.
 - 3) Drag the cursor to the bottom right of the group of controls and release the mouse button.

As you drag the cursor, a dashed box appears showing what is contained in your selection. Make sure it is big enough to include the entire length of all the controls.

When you release the mouse button, a border with its green handles appears around the controls you selected.

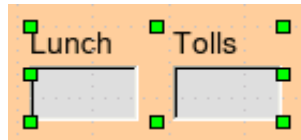

Figure 193: Selecting multiple controls

Move the cursor over one of the fields. It changes to a drag icon. Drag the group of controls to where you want them.

Tip

When either changing size or moving a control, two properties of the Form Design toolbar should be selected: *Snap to Grid*, and *Guides when Moving*. Your controls will line up better, and an outline of what you are moving moves as the cursor moves.

You should also have both rulers active (**View > Ruler**).

Step 1: Change the Date field.

- 1) *Control+click* the Date field to select it.
- 2) Move the cursor over the middle green handle on the right side. It should change to a double-headed arrow.
- 3) Hold the left mouse button down as you drag the cursor to the right until the length is 6 cm. The vertical dashed line is lined up with the 6. Release the mouse button.
- 4) Click the Control icon in the Form Controls toolbar. The *Properties: Date Field* window opens. Each line contains a property of the field.

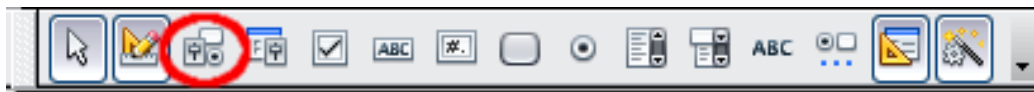

Figure 194: Form Controls toolbar

- Scroll down to the *Date format* property. This is a dropdown list with Standard (short) as the default setting. Click it to open the list. Select the *Standard (long)* entry.
- Scroll down to the *Dropdown* property. Its default setting is No. It is also a dropdown list. Click to open the list. Select Yes.

Tip

To see what the Date field will look like, click the **Form Mode On/Off** icon (the second icon from the left in Figure 194). You can do this any time you want to see the form with the changes you have made.

Step 2: Shorten the width of some fields.

All of the fields with a label containing the word payment are too wide. They need shortening before the controls are moved.

- 1) *Control+click* the BPayment field.

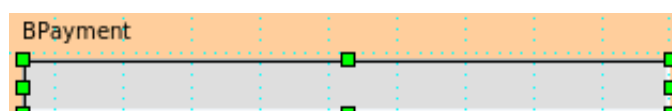

Figure 195: Selecting a field

- 2) Move the cursor over the middle green handle on the right. The cursor becomes a double-headed arrow.
- 3) Drag the cursor to the left until the field is 2.5 cm wide (1 inch).

Tip

If you have the *Snap to Grid* and *Guides when moving icons* selected in the Design Format toolbar, you will see how wide the field is as you shorten it.

- 4) Repeat these steps to shorten these fields: Lpayment, SPayment, SnPayment, Mpayment, and MiscPayment.

Step 3: Move the controls to group them by category.

We want to move the controls so that they look like Figure 196.

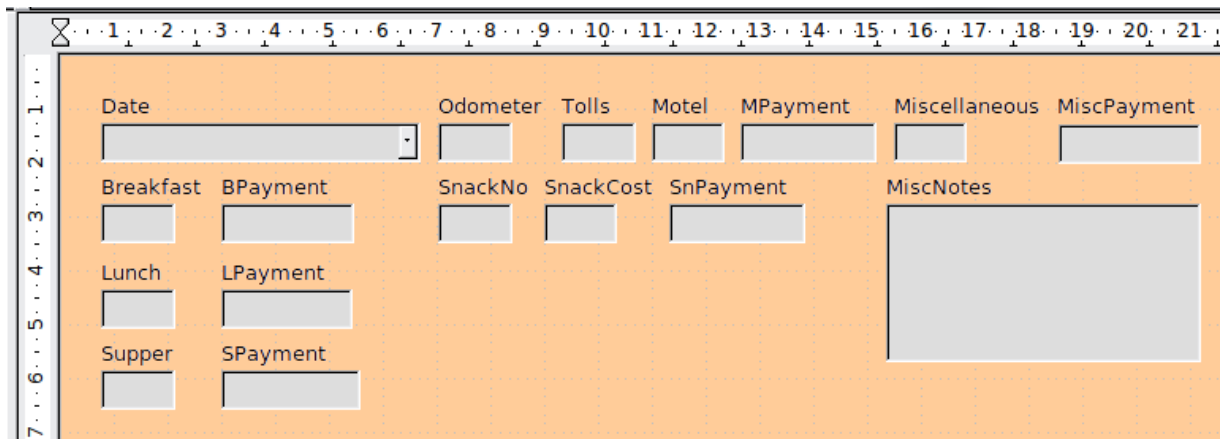

Figure 196: Positioning of controls

- 1) Click the first control you want to move. A border appears around the control with eight green handles.
- 2) Move the cursor over the label or field of the control. It change shape to a drag icon.
- 3) Drag and drop the control to where you want it.

Caution



Do not use *Control+click* when moving a field. It moves either the field or the label but not both. To move both, use a *mouse click* and drag to the desired spot.

- 4) Use the same steps to move the rest of the controls to where they belong.

Step 4: Change the label wording.

Field names have been single words for some time. However, the labels for the fields in a form can be more than one word. So, we will change them by editing the text in the label.

Note

The table wizard in Base contains suggested fields which are single words, often consisting of two separate words. Table names in the wizard have been that way also. However, you can use multiple words as the name of a field, label, or table. We will do so when we create a list box for each of the *payment type* controls.

- 1) *Control+click* the SnackNo label. Do one of the following:
 - Right-click the SnackNo label and select **Control** from the pop-up menu.
 - Or, click the Control icon in the Form Control toolbar (Figure 194).
 - 2) The dialog that opens is labeled Properties: Label Field. It contains all of the properties of the selected label.
 - In the Label selection, edit the label to Snack No.
 - Close the Properties dialog.
 - 3) Use the same procedure to change these labels as well: BPayment to Payment, LPayment to Payment, SPayment to Payment, Miscellaneous to Misc., SnackCost to Snack Cost, MPayment to Payment, MiscPayment to Misc. Payment, and MiscNotes to Misc. Notes.
-

Tip

You can modify all of the listings in the Properties window. For example, if you change the Alignment from Left to Center, the word or words in the label are centered within the label. When you have some time, you might want to experiment with different settings just to see the results you get.

Step 5: Change the widths of the labels and fields.

We want the following controls to be 2 cm wide (0.8 inches): Breakfast, Lunch, Supper, Odometer, Snack No., Tolls, Snack Cost, Motel, and Misc. All of the payment fields were changed in step 2, but Misc. Payment needs to be changed to 3 cm (1.2 inches).

- 1) Right-click Breakfast and choose **Position and Size**. On the Position and Size dialog, change Width to 2 cm.
 - 2) Repeat for the other listed controls, using 3 cm for Misc.Payment.
-

Caution

When changing the position or size of an entire control, use the Position and Size dialog or the drag and drop method.

When working with either the label or the field (but not both at the same time), you can use the Properties dialog to make these changes when you want to be exact. However, you need to be careful not to accidentally select the entire control for use with the Properties dialog or you will apply the exact same values to both the label and field. For example, if you enter the values for a new position, both the field and the label moves to the same position and the field is positioned on top of the label. Then you have to move each of them to where you want them.

Note

To open the Properties window, right-click a control and select **Control** from the pop-up menu. Or, you can click the Control icon in the *Form Controls* toolbar. Just be careful, and use *Control+Z* to undo any mistakes you may make. Detailed instructions on how to use the Properties window will be in the *Base Guide*.

Step 6: Replace fields with other fields.

We want to replace the PaymentType field with a List Box. Then we can choose the type of payment from the Payment Type table rather than having to manually enter the type. In my case, each of my payment types begins with a different letter. If I enter the first letter of the payment type, the rest of the word automatically appears. I can then go to the next field.

- 1) *Control+click* the Payment field for Breakfast. The green handles appear around the field but not around the Label.

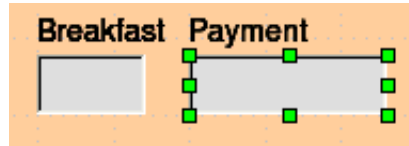

Figure 197: Selecting a field of a control

- 2) *Right-click* within the green handles and select **Replace with > List Box**.
- 3) *Click* the Control icon in the Form Controls toolbar to open the Properties: List Box dialog.
- 4) On the General tab, scroll down to the Dropdown selection. Change the No to Yes.

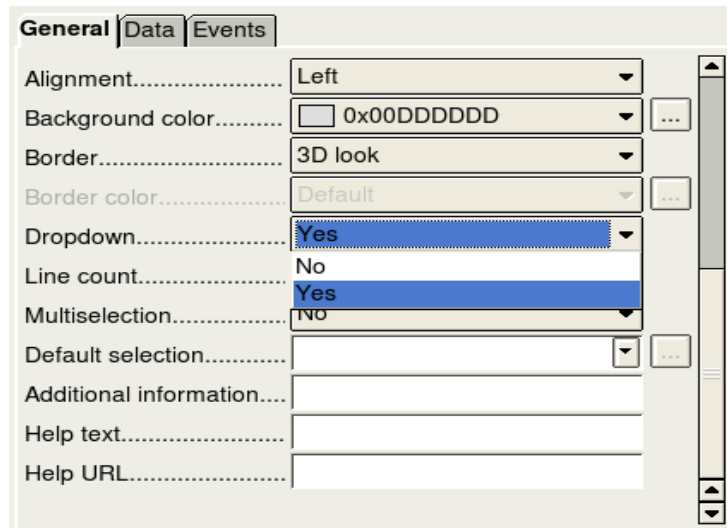

Figure 198: Dropdown list open to reveal choices

- 5) Click the **Data** tab.
 - *Type of list contents* is a dropdown list. Change it to *Sql*.

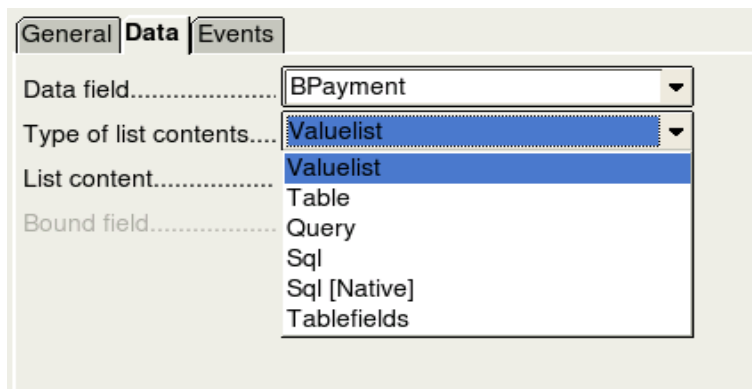

Figure 199: Type of list contents dropdown list

- Type the following **exactly** as it is in the *List contents* box:

```
SELECT "Type", "Type" FROM "Payment Type"
```

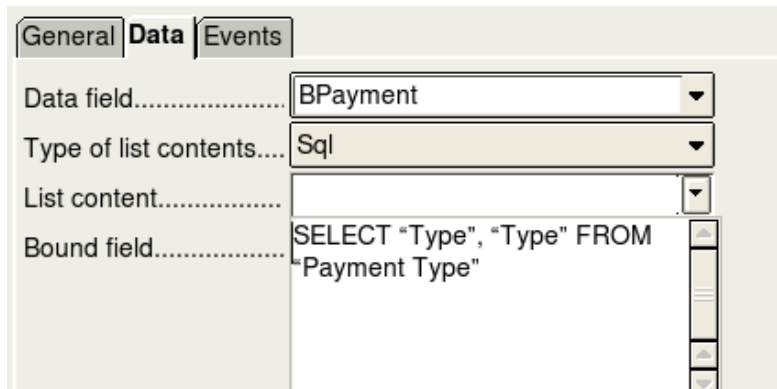

Figure 200: List content for payment type fields

Note

What you wrote is called an SQL command. The words *SELECT* and *FROM* are written in capital letters because they are commands. When the command *SELECT* is used, it requires a field name within quotation marks and then the field's alias, also within quotation marks. In this case, the field and its alias are the same. The *FROM* command requires the name of the table which contains the field. Single-word table names do not require quotation marks, but multiple-word table names do.

- Repeat these steps for the payment fields for Lunch, Supper, Motel, Snacks, and Misc. The main form should look like Figure 201 as far as where the controls are located. It also shows what the Note control should look like. Those changes are explained in the next step.
- Close the Properties window.

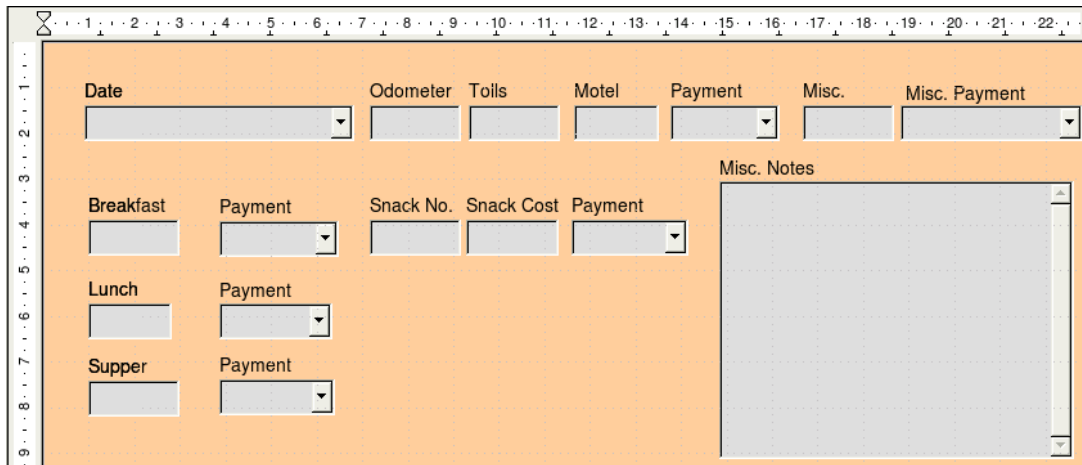

Figure 201: Position of controls in main form

Step 7: Change the Misc. Notes field.

We want the Misc. Notes control, which has a field type of Memo, to have a vertical scrollbar for additional text space if desired.

- 1) *Control+click* the *Misc. Notes* field. The green handles should surround the field but not its label.

- 2) Click the **Control** icon to open the Properties window (Figure 202).
- 3) Scroll down to the *Scrollbars* setting. Change the selection from *None* to *Vertical* in this dropdown list.

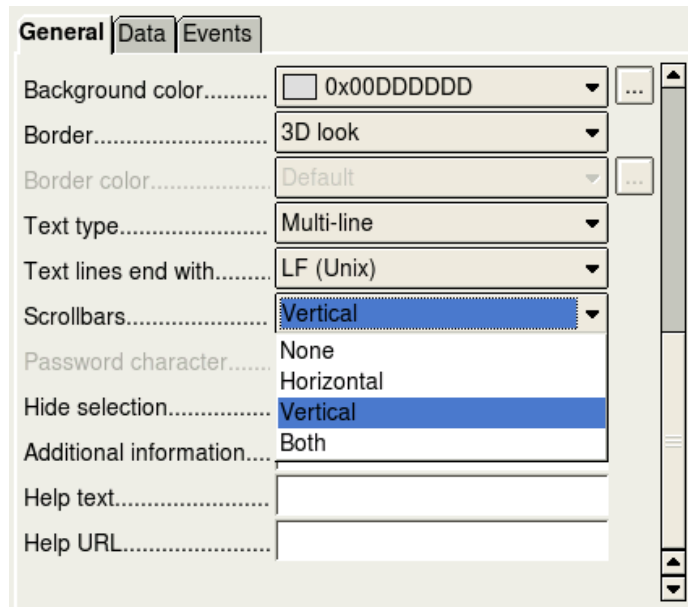

Figure 202: Scrollbar selections in the Properties window

- 4) Close the Properties window.
- 5) Lengthen the Misc. Notes field by moving the cursor over the middle green handle at the bottom of the field and dragging down until the length is 6 cm (2.4 inches).

Step 8: Change labels and fields in the subform.

The subform is located at the bottom of the form. We want to widen the Date column, change the field in the PaymentType column to a list box, and change the label for the PaymentType column to two words.

To widen the Date column, move the mouse pointer over the dividing line between the Date and FuelCost columns. When the pointer changes shape, click and drag to move the divider to the right.

To change the PaymentType column:

- 1) Right-click the label PaymentType and choose **Replace with > List box** from the menu.
- 2) Again right-click the label PaymentType to open the menu. Select **Column** to open the Properties dialog (Figure 203).
- 3) In the *Label* box, change PaymentType to Payment Type.
- 4) Click the **Data** tab.
- 5) From the *Type of list contents* dropdown list, select *Sql*.
- 6) Type the following exactly as it is written:

```
SELECT "Type", "Type" FROM "Payment Type"
```
- 7) Close the Properties dialog.

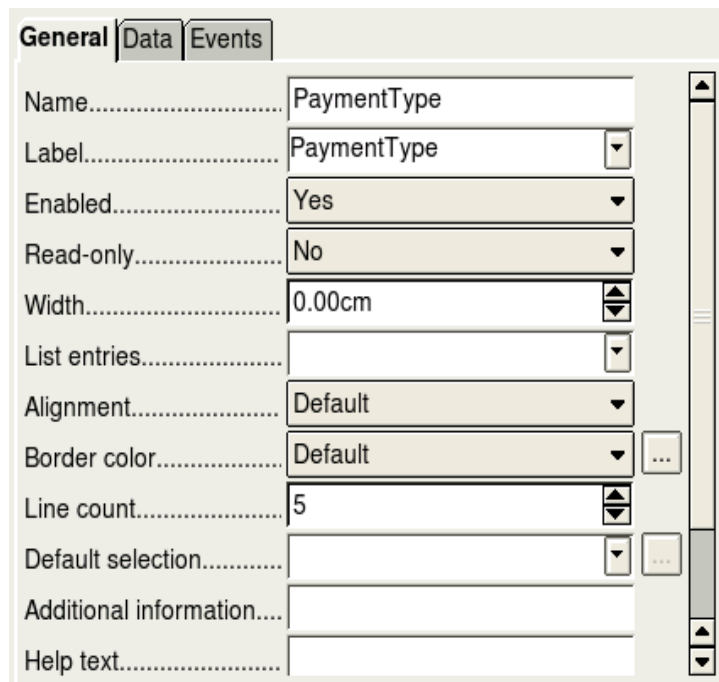

Figure 203: Properties window for control in a subform

Step 9: Add headings to groups.

This step is easier to do if you have end-of-paragraph markers visible. Choose **View > Nonprinting Characters** to turn them on.

- 1) Make sure the cursor is in the upper left corner. If it is not, click in that corner to move it there.
- 2) Press the *Enter* key to move the cursor down to the space between the Date field and the Breakfast field.
- 3) Change the *Apply Styles* dropdown list from *Default* to *Heading 2*.

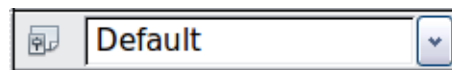

Figure 204: Apply Styles list

- 4) Use the spacebar to move the cursor to where you want the heading to start.
- 5) Type the heading *Meals*.
- 6) Use the spacebar to move the cursor to the center of snack area.
- 7) Type the heading *Snacks*.
- 8) Use the *Enter* key to move the cursor between the Supper control and the subform.
- 9) Use the spacebar to move the cursor to the center of the subform.
- 10) Type the heading *Fuel Data*.

Note

If you know how to use styles, you can open the Styles and Formatting window using *F11*. Right-clicking the Heading 2 paragraph style allows you to modify the appearance of all three headings. See Chapter 6 of the *Writer Guide* for details.

Step 10: Change the background of a form.

The background for a form can be a color, or a graphic (picture). You can use any of the colors in the Color Table at **Tools > Options > OpenOffice.org > Colors**. If you know how to create custom colors, you can use them. You can also use a picture (graphic file) as the background.

If you choose a dark background, you may need to change many of the labels and headings so they can be seen.

- 1) Select the labels of the top row of controls.
 - a) *Control+click* the Date label.
 - b) *Control+shift+click* the rest of the labels of the top row. The border will gradually grow to the right as you do this until all the labels are enclosed in it.

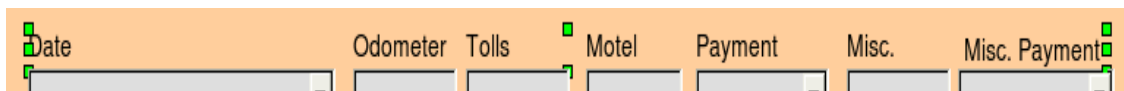

Figure 205: Selecting multiple labels at one time

- c) Click the **Control** icon in the Design Form toolbar to open the Properties dialog.
 - d) Change the *Background color* selection from *Default* to *Light cyan*. (This is a dropdown list.) Close the Properties dialog.
- 2) Select the other labels in the same way and then change their background color.
- 3) To change the font color for the headings:
 - a) Open Styles and Formatting using the *F11* key. Make sure the Paragraph icon is selected at the left end of the icons in Figure 206.
 - b) Right-click the Heading 2 style to open a pop-up window and select **Modify** from this menu.
 - c) In the *Paragraph Style Heading 2* dialog, click the **Font Effects** tab. Change *Font color* from *Automatic* to *Light Cyan*.

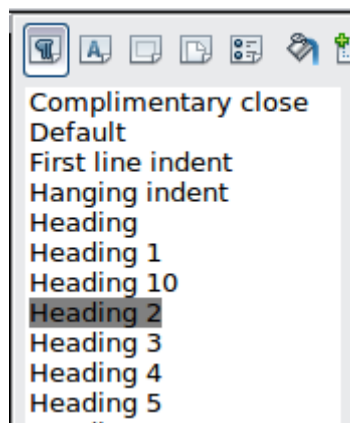

Figure 206: Styles and Formatting window

- d) Click **OK** to close the dialog.

Tip

Learning how to use styles can be very helpful at times. By using styles, we changed the font color for all three headings at one time. There are other methods of changing the font color, but they require repeating the same steps for each heading.

- 4) To add a graphic to the background:
 - a) Right-click on the background and select **Page** from the pop-up menu.
 - b) On the Page Style dialog, click the Background tab, change the As dropdown list from *Color* to *Graphic*.
 - c) Click Browse to find and select the graphic file you want to use, and click **Open**. In the Type section of the Background tab, select *Area*.
 - d) Click **OK** to close the dialog. The form should look like Figure 207.

Date	FuelCost	FuelQuantity	Odometer	Payment Type

Figure 207: Finished form

Step 11: Change the tab order.

The **Tab** key moves the cursor from field to field. This is much easier to do than to click each field to enter data into it. It also permits us to group our expenses into areas before we begin entering data. For example, all of our meal receipts can be grouped together as can our snacks and also our fuel purchases.

- 1) **Control+click** the Date field.
- 2) Click the **Form Design** icon in the Form Controls toolbar to open the Form Design toolbar (Figure 208), or choose **View > Toolbars > Form Design** to open this toolbar.
- 3) Click the **Activation Order** icon (circled).



Figure 208: Form Design toolbar with Activation Order icon circled

- 4) Rearrange the order of the fields in the Tab Order window.
 - a) Find the txtMPayment listing near the bottom of the list and click it.
 - b) Click the **Move Up** button until txtPayment is just below fmtMotel.
 - c) Use the same two steps to put the fields in the same order as in Figure 209. Click **OK**.

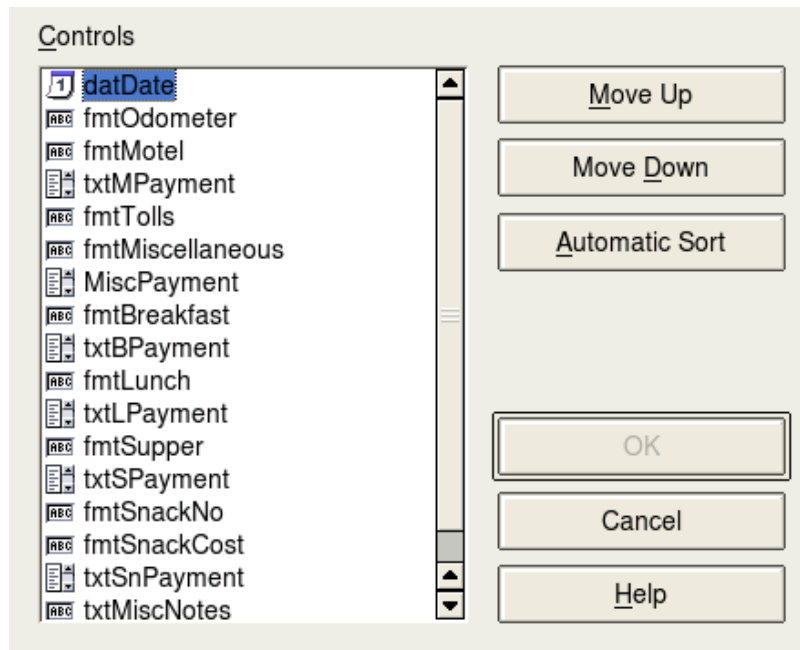

Figure 209: Tab order for the main form

- 5) Save and close the form.
- 6) Save the database.

Creating forms and subforms in Design View

This method requires using the *Form Controls* and *Form Design* toolbars extensively. These techniques are beyond the scope of this document. Instructions for creating forms using Design view will be described in the *Database Guide*.

Accessing other data sources

OpenOffice.org allows data sources to be accessed and then linked into OOO documents. For example, a mail merge links an external document containing a list of names and addresses into a letter, with one copy of the letter being generated for each entry.

To access a data source that is not a *.odb file:

- 1) **File > New > Database** opens the *Database Wizard* window.
- 2) Select **Connect to an existing database**. Click the arrow next to the *Database type* field and select the database type from the dropdown list. Click **Next**.
- 3) Click *Browse* and select the database. Click **Next**.
- 4) Accept the default settings: *Register the database for me*, and *Open the database for editing*. Click **Finish**. Name and save the database in the location of your choice.

Accessing a spreadsheet as a data source

Accessing a spreadsheet is similar to accessing other databases:

- 1) Choose **File > New > Database**.
- 2) Select *Connect to an existing database*. Select *Spreadsheet* as the *Database type*.
- 3) Click **Browse** to locate the spreadsheet you want to access. If the spreadsheet is password protected, check the *Password required* box. Click **Next**.
- 4) If the spreadsheet requires a user's name, enter it. If a password is also required, check its box. Click **Next**.

Using this method of accessing a spreadsheet, you cannot change anything in the spreadsheet. You can only view the contents of the spreadsheet, run queries, and create reports based upon the data already entered into the spreadsheet.

Note All changes in a spreadsheet must be made in the spreadsheet itself, using Calc. After modifying the spreadsheet and saving it, you will see the changes in the database. If you create and save an additional sheet in your spreadsheet, the database will have a new table the next time you access it.

Registering *.odb databases

Databases created by OOo2.x or later are in the *.odb (OpenDocument Base) format. Other programs can also produce databases in this format. Registering a *.odb database is simple:

- 1) Choose **Tools > Options > OpenOffice.org Base > Databases**.
- 2) Under *Registered databases*, click **New**.
- 3) Browse to where the database is located.
- 4) Make sure the registered name is correct.
- 5) Click **OK**.

Note Sometimes when updating OOo to a newer version, your list of registered database files disappears. When that happens, you need to use these steps to register your database files with your latest version of OOo.

Using data sources in OpenOffice.org

Having registered the data source, whether a spreadsheet, text document, external database or other accepted data source, you can use it in other OpenOffice.org components including Writer and Calc.

Viewing data sources

Open a document in Writer or Calc. To view the data sources available, press *F4* or select **View > Data Sources** from the pull-down menu. This brings up a list of registered databases, which will include Bibliography and any other database registered, such as the Automobile database created earlier in this chapter.

To view each database, click on the **+** to the left of the database's name (see Figure 210). This brings up Tables and Queries. Click on the **+** next to Tables to view the individual tables created. Now click on a table to see all the records held in it.

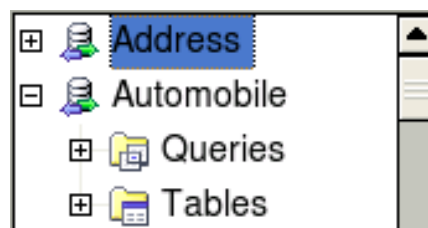

Figure 210: Databases

Editing data sources

Some data sources can be edited in the View Data Sources dialog. A spreadsheet can not. A record can be edited, added, or deleted.

The data is displayed on the right side of the screen. Click in a field to edit the value.

Beneath the records are five tiny buttons. The first four move backwards or forwards through the records, or to the beginning or end. The fifth button, with a small star, inserts a new record.



Figure 211: View Data Sources navigation buttons

To delete a record, right-click on the gray box to the left of a row to highlight the entire row, and select **Delete Rows** to remove the selected row.

	FuelID	Date	FuelCost	FuelQuantity	Odometer	PaymentType	
▶	1	04/12/07	26.45	11.650	90997.9	Kevin	
▶	2		24.99	8.299	91354.7	Dan	
▶	3		27.50	12.557	91699.3	Cash	
▶	4		35.12	10.233	92213.5	Kevin	

Record 1 of 4 (1)

Figure 212: Deleting a row in the Data View window

Launching Base to work on data sources

You can launch OOo Base at any time from the View Data Source pane. Just right-click on a database or the Tables or Queries icons and select **Edit Database File**. Once in Base, you can edit, add, and delete tables, queries, forms, and reports.

Using data sources in Writer and Calc

Data can be placed into Writer and Calc documents from the tables in the data source window. In Writer, values from individual fields can be inserted. Or, a complete table can be created in the Writer document. One common way to use a data source is to perform a mail merge.

Tip

Choosing **Tools > Mail Merge Wizard** or clicking on the Mail Merge icon on the View Data Source pane launches the Mail Merge wizard which steps you through creating a mail merge document. See Chapter 11 in the *Writer Guide*.

Writer documents

To insert a field from a table opened in the data source window into a Writer document, click on the field name (the gray square at the top of the field list) and, with the left mouse button held down, drag the field onto the document. In a Writer document, it will appear as <FIELD> (where FIELD is the name of the field you dragged).

For example, to enter the cost of meals and who paid for them on a certain date of a vacation:

- 1) Open the list of data sources (*F4*) and select the Vacations table in the Automobile database.
- 2) Use this sentence: "On (date), our breakfast cost (amount) paid by (name), our lunch cost (amount) paid by (name), and our supper cost (amount) paid by (name)." But only type "On , our breakfast cost paid by , our lunch cost paid by , and our supper cost paid by ."
- 3) To replace (date), click the field name Date in the data source window and drag it to the right of the word *On*. The result: On <Date>. If you have Field shadings turned on (**View > Field shading**), <Date> has a gray background. Otherwise it does not.
- 4) To replace first (amount), click the Breakfast field name and drag it to the right of *our breakfast cost*. Make sure you have the proper spacing between the field names and the words before and after them. Result: breakfast cost <Breakfast>.
- 5) To replace the first (name), click the Bpayment field name and drag it to the right of *paid by*. Result: paid by <Bpayment>.
- 6) In the same way, fill in the rest of the fields in the sentence.
 - Use <Lunch> and <LPayment> for the second set of (amount) and (name) in the sentence.
 - Use <Supper> and <SPayment> for the third set of (amount) and (name) in the sentence.

- 7) Final result: On <Date>, our breakfast cost <Breakfast> paid by <BPayment>, our lunch cost <Lunch> paid by <LPayment>, and our supper cost <Supper> paid by <SPayment>.
- 8) Add data to the fields of the sentence:
 - Click the gray box to the left of the row of data you want to add. That row should **be** highlighted like the second row of Figure 213.
 - Click the *Data to Fields* icon (circled). This should fill the fields with the data from the row you chose.
 - Click another row and then click this icon again. The data in the sentence changes to this selected row of data.
 - Save the document if you want to use it as an example later.

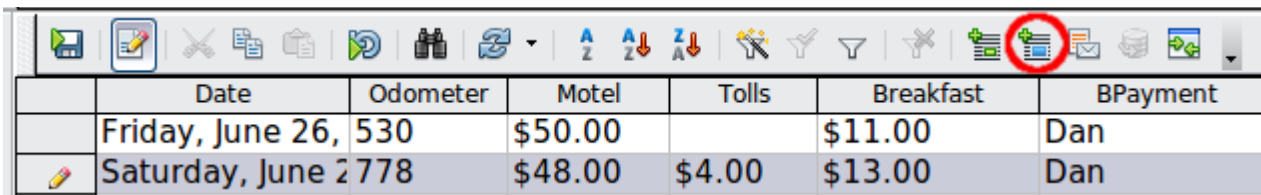

	Date	Odometer	Motel	Tolls	Breakfast	BPayment
	Friday, June 26,	530	\$50.00		\$11.00	Dan
	Saturday, June 27	778	\$48.00	\$4.00	\$13.00	Dan

Figure 213: Selected row in data source window

Adding data in table format is a little easier and takes perhaps fewer steps. Some of the steps will be quite similar.

- 1) Navigate to the place you want to place the table and click the location.
- 2) *Control+Click* the gray box to the left of each row of the data source that you want to be a row in your table when the rows are not consecutive. To select consecutive rows, click the gray box to the left of the top desired row and *Shift+click* the bottom desired row.
- 3) Click the *Data to text* icon to open the Insert Database Columns dialog (Figure 214). (The *Data to text* icon is to the left of the *Data to Fields* icon in Figure 213.)
- 4) Move the fields you want in your table from the *Database Column(s)* list to the *Table column(s)* list.
 - To place the fields in the order you select, click the field and use the *single arrow* to move the fields in the order you desire. You can also limit the fields you use to less than all of the fields available.
 - If you want to use all of the fields, use the *double arrow* pointing to the right to move all of them at one time. The order of the fields in the table you create will be the same as in the data source table.
 - To remove a single field from the *Table Column(s)* list, click the field and use the *single arrow* pointing to the left.
- 5) To start over, click the *double arrow* pointing to the left.

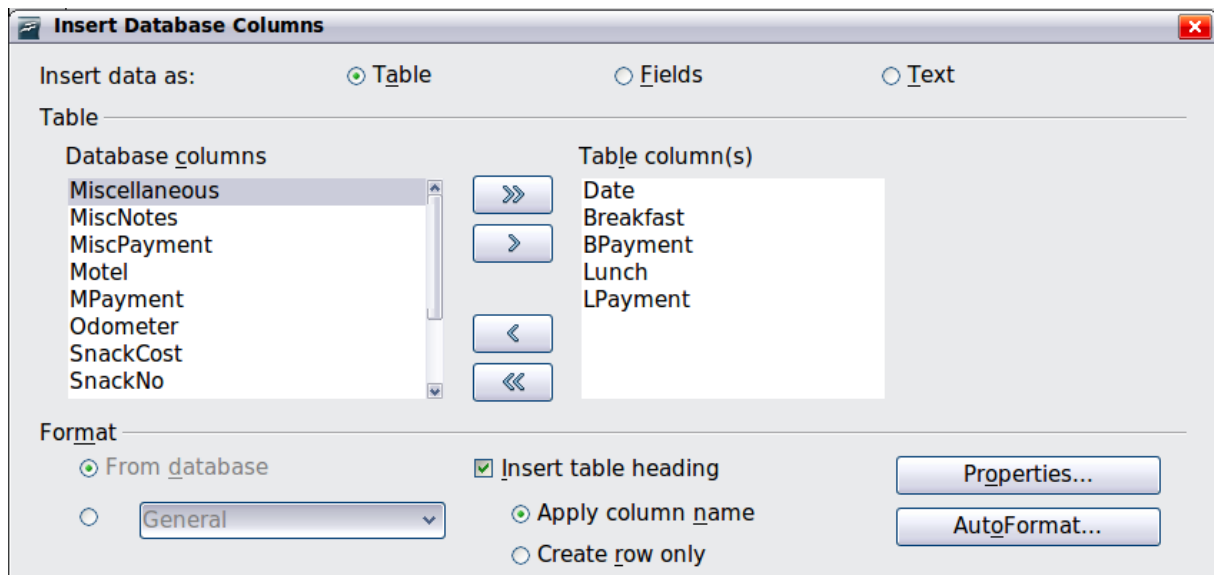

Figure 214: Insert Database Columns dialog

- 6) Select the settings for your table. Use the default settings as in Figure 214.
- 7) Click **OK**. Save the document.

Calc spreadsheets

There are two ways to enter data in a Calc spreadsheet. One enters the data into the spreadsheet cells. The other creates records in the spreadsheet just like they are done in creating a form in a database. While you can directly access the data in the spreadsheet cells, you can only see the data in the records created in the spreadsheet.

Entering data directly to the spreadsheet cells uses the *Data to Text* icon as we did to make a table in a Writer document. But differences exist in these two situations.

The steps are straightforward.

- 1) Click the cell of the spreadsheet which you want to be the top left of your data including the column names.
- 2) Use F4 to open the database source window and select the table whose data you want to use.
- 3) Select the rows of data you want to add to the spreadsheet:
 - Click the gray box to the left of the row you want to select if only selecting one row. That row is highlighted.
 - To select multiple rows, hold down the *Control* key while clicking the gray box of the rows you need. Those rows are highlighted.
 - To select all the rows, click the gray box in the upper left corner. All rows are highlighted.
- 4) Click the *Data to text* icon to insert the data into the spreadsheet cells.
- 5) Save the spreadsheet.

Adding records to a spreadsheet is fairly easy. You need to have the Data Source window open, your spreadsheet open, and the table you want to use selected.

- 1) Click the gray box above the field name for the table's ID field.
- 2) Drop and drag the gray box for the table's ID field to where you want the record to appear in the spreadsheet.

- 3) Repeat until you have moved all of the fields you need to where you want them.
- 4) Name and save the spreadsheet.
- 5) Click a row of the table in the Data Source window.
- 6) Drag the data in the ID field in the selected row onto the ID field in the spreadsheet. The Save icon should activate.
- 7) Click the *Edit File* button to make the spreadsheet read only. Click **Save** when asked if you want to save the file.
- 8) The Data Source window goes blank, the fields in the spreadsheet are populated with data from the row you selected, and the Form Navigation toolbar appears at the bottom of the spreadsheet.

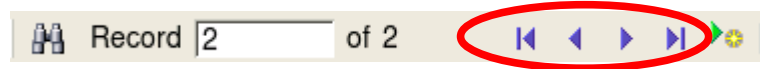

Figure 215: Navigation arrows of a form

- 9) Click the arrows on the Form Navigation toolbar to view the different records of the table. (The arrows are circled in red.) The number in the box changes when you change the record number by clicking an arrow. The data in the fields changes correspondingly to the data for that particular record number.

Entering data in a form

Records are used to organize the data we enter into a form. They also organize the data we enter into a subform.

Each type of field allows a different method to enter the data. In many if not all cases, more than one method can be used.

The first step to entering data in a form is to open it from the main database window (Figure 175).

- 1) Click the Forms icon in the *Database* list.
- 2) Find the form's name in the *Forms* list (Vacations).
- 3) Double-click the form's name.

The quickest way to enter a date in the Date field is to click the arrow that opens the dropdown calendar. Then click the day the you want. Then press the *Tab* key to go to the Odometer field.

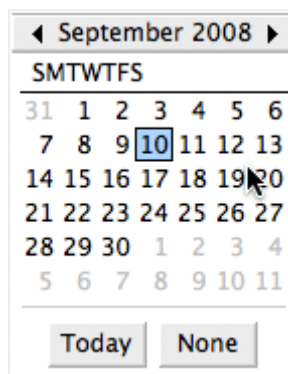

Figure 216: Calendar dropdown

The Odometer, Tolls, and Motel fields are numerical fields. Enter values directly into them, or use the *up* and *down arrows*. When the value is entered, use the *Tab* key to go to the next field.

- Clicking the *up arrow* increases the value, and the *down arrow* decreases the value one unit.
- These two arrows only change the numerals to the left of the decimal place.
- Numerals to the right of the decimal place must be changed by deleting them and typing the desired ones.

The Motel's Payment field is a dropdown list. If as in my case, all of the elements of the list start with different letters, typing the first letter selects the desired entry.

- If two or more elements of the list have the same first letter, repeated typing of the first letter will cycle through the elements with this same first letter.
- When the selection is correct, use the *Tab* key to go to the Misc. field.

The rest of the fields of the main form are either numerical fields or dropdown lists until we reach the Misc. Notes field. It is a text field. Type anything you desire in this field just as you would any simple text editor.

Note

Since the *Tab* key is used to move between fields, it can not be used in a text field. All spacing must be done by the *spacebar*. Finally, the *Enter* key only acts as a line break to move the cursor to the next line. While the *Enter* key will move from non-text fields to non-text fields, it will not do so from a text field. Use the *Tab* key instead.

If we did not have a subform for fuel data, pressing the *Tab* key in the last field would save all of the fields, clear them, and make the form ready to accept data on the second record.

Since we have a subform form, using the *Tab* key places the cursor in the first Date field of the subform with the date automatically entered to match the Date field of the main form.

The FuelCost, FuelQuantity, and Odometer fields are numerical fields. The Payment field is a dropdown list. Enter the data just as you did in the main form, and use the *Tab* key to go to the next field.

When you use the *Tab* key to leave the Payment field, it goes to the Date field of the next line and automatically enters the date. Now you can enter your second set of fuel data for this day.

To move to another record when the form has a subform, click any of the fields of the main form. In this case, click the Date field of the main form. Then use the directional arrows at the bottom. There are four of them from left to right: *First Record*, *Previous Record*, *Next Record*, and *Last Record* (Figure 215). To the right of these arrows is the *New Record* icon.

To create a new record while in another record in the main form, click either the *Next Record* icon or the *New Record* icon.

Tip

The number in the Record box is the number of the record whose data is shown in the form.

If you know the number of the record you want, you can enter it into the record box and then press *Enter* to take you to that record.

Figure 217 is a record with data inserted in its fields.

The screenshot shows a Microsoft Access form with the following sections:

- Date:** Friday, May 25, 2007
- Odometer:** 530.0
- Tolls:** (empty)
- Motel:** \$50.00
- Payment:** Kevin
- Misc.:** \$2.00
- Misc. Payment:** Cash

Meals Section:

- Breakfast:** \$11.00, Payment: Dan
- Lunch:** \$15.00, Payment: Dan
- Supper:** \$13.00, Payment: Kevin

Snacks Section:

- Snack No.:** 3
- Snack Cost:** \$5.00
- Payment:** Cash

Misc. Notes: Bought two toothbrushes for \$2.00

Fuel Data Table:

Date	Fuel Cost	Fuel Quantity	Odometer	Payment Type
Friday, May 25, 2007	\$16.00	14.692	704.2	Kevin
Friday, May 25, 2007	\$7.00	6.428	778.7	Dan

Record 1 of 2

Figure 217: Sample record of the Vacation form and subform

Creating queries

Queries are used to get specific information from a database. Query results are special tables within the database.

To demonstrate the use of queries, we will use two different methods:

- Using our CD-Collection table, we will create a list of albums by a particular artist. We will do this using the Wizard.
- The information we might want from the Fuel table includes what our fuel economy is. We will do this using the Design View. (Queries that require calculations are best created with the Design view.)

Using the Wizard to create a query

Queries created by the wizard provide a list or lists of information based upon what one wants to know. It is possible to obtain a single answer or multiple answers, depending upon the circumstances.

In the main database window (Figure 175), click the Queries icon in the Databases section, then in the Tasks section, click *Use Wizard to Create Query*. The Query Wizard window opens (Figure 218). The information we want is what albums are by a certain musical group or individual (the album's author). We can include when each album was bought.

Note When working with a query, more than one table can be used. Since different tables may contain the same field names, the format for naming fields in a query is *Table name.field name*, with a period (.) between the table name and the field name. For example, The Lunch field of the Vacation table used in a query has the name *Vacation.Lunch*.

Step 1: Select the fields.

- 1) Select the CD-Collection table from the dropdown list of tables.
- 2) Select fields from the CD-Collection table in the *Available fields* list.
 - a) Click *Artist*, and use the > button to move it to the *Fields in the Query* list.
 - b) Move the AlbumTitle and DatePurchased fields in the same manner.
 - c) Click **Next**.

Tip

To change the order of the fields, select the field you want to move and click the up or down arrow.

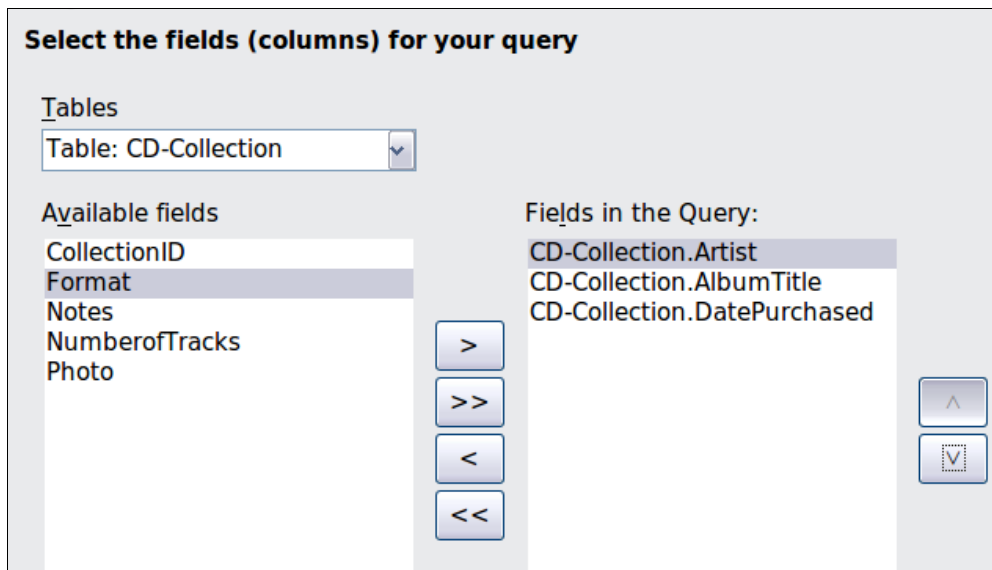

Figure 218: First page of the Query Wizard

Step 2: Select the sorting order.

Up to four fields can be used to sort the information of our query. A little simple logic helps at this point. Which field is most important?

In our query, the artist is most important. The album title is less important, and the date purchased is of least importance. Of course, if we were interested in what music we bought on a given day, the date purchased would be the most important.

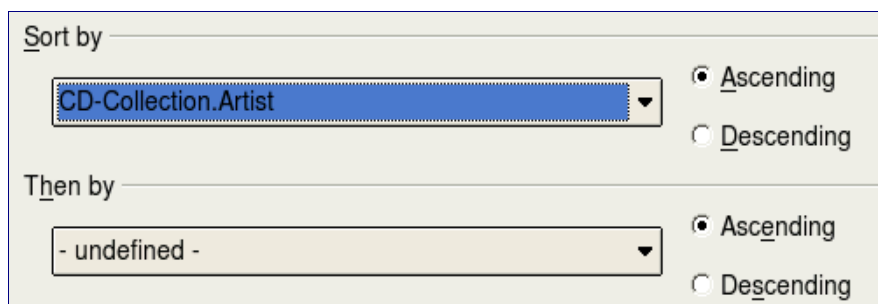

Figure 219: Sorting order page

- 1) Click the first *Sort by* dropdown list.
 - Click *CD-Collection.Artist* to select it.
 - To list the artists in alphabetical order (a-z), select *Ascending* on the right.

- 2) Click the second *Sort by* dropdown list.
 - Click *CD-Collection.ArtistTitle*. and select *Ascending*.
- 3) Repeat this process for *CD-Collection.DatePurchased*.
- 4) Click **Next**.

Step 3: Select the search conditions.

The search conditions allow us to compare the name we entered with the names of the artist in our database and decide whether to include a particular artist in our query or not.

- *is equal to*: the same as
- *is not equal to*: not the same as
- *is smaller than*: comes before
- *is greater than*: comes after
- *is equal or less than*: the same as or comes before
- *is equal or greater than*: the same as or comes after
- *like*: similar to in some way

Note

These conditions apply to numbers, letters (using the alphabetical order), and dates.

- 1) Since we are only searching for one thing, we will use the default setting of *Match all of the following*.
- 2) We are looking for a particular artist, so select *CD-Collection. Artist* in the Fields list and *is equal to* as the Condition.
- 3) Type the name of the artist in the *Value* box. Click **Next**.

Step 4: Select type of query.

We want simple information, so the default setting: *Detailed query* is what we want. Click **Next** at the bottom of the window.

Note

Since we have a simple query, the *Grouping* and *Grouping conditions* are not needed. Steps 5 and 6 of the wizard are skipped in our query.

Step 7: Assign aliases if desired.

We want the default settings. Click **Next**.

Step 8: Overview.

Name the query (suggestion: *Query_Artists*). To the right of this are two choices. Select *Display Query*. Click **Finish**.

Using the Design View to create a query

Creating a query using Design View is not as difficult as it may first seem. It may take multiple steps, but each step is fairly simple.

What fuel economy is our vehicle getting (miles per gallon in the USA)? This question requires creating two queries, with the first query used as part of the second query.

Step 1: Open the first query in Design View.

Click **Create Query in Design View**.

Step 2: Add tables.

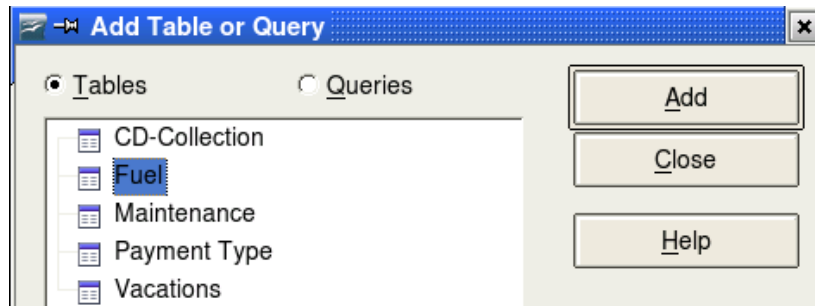

Figure 220: Add Tables or Query window

- 1) Click *Fuel* to highlight it.
- 2) Click **Add**. Click **Close**.

Tip

Move the cursor over the bottom edge of the fuel table (Figure 221) and drag the to make it longer and easier to see all of the fields in the table.

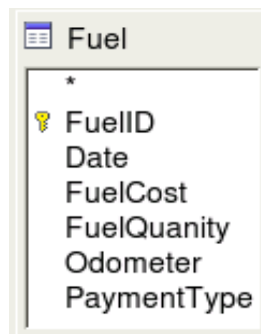

Figure 221: Fuel table in query

Step 3: Add fields to the table at the bottom.

- 1) Double-click the *FuelID* field in the Fuel table.
- 2) Double-click the Odometer field.
- 3) Double-click the FuelQuantity field.

The table at the bottom of the query window should now have three columns.

	FuelID	Odometer	FuelQuantity
Field	FuelID		
Alias			
Table	Fuel	Fuel	Fuel
Sort			
Visible	<input checked="" type="checkbox"/>	<input checked="" type="checkbox"/>	<input checked="" type="checkbox"/>
Function			
Criterion			

Figure 222: Query table

Step 4: Set the criterion for the query.

We want the query's FuelID to begin with the numeral 1.

- 1) Type >0 in the Criterion cell under FuelID in the query table.
- 2) Click the *Run Query* icon in the Query Design toolbar.



Figure 223: Query Design toolbar

Figure 224 contains the Fuel table with my entries and the query results based upon the Fuel table: the query results are in the right table.

FuelID	Date	FuelCost	FuelQuantity	Odometer
0	Friday, M	\$16.00	14.690	704.2
1	Friday, M	\$7.00	6.430	778.7
2	Saturday	\$20.00	19.570	1032.3
3	Saturday	\$16.00	15.150	1239.4
4	Sunday, I			
<AutoFie				

FuelID	Odometer	FuelQuantity
1	778.7	6.430
2	1032.3	19.570
3	1239.4	15.150
4		
<AutoFie		

Figure 224: Fuel table and query of the fuel table

Step 5: Save and close the query.

Since this query contains the ending odometer reading for our calculations, name it *End-Reading* when saving it. Then close the query.

Step 6: Create the query to calculate the fuel economy.

- 1) Click **Create Query in Design View** to open a new query.
- 2) Add the Fuel table to the query just as you did in step 2: Add tables But, **do not** close the Add Tables window.
- 3) Add the End-Reading query to this query.
 - a) Click *Queries* to get the list of queries in the database.

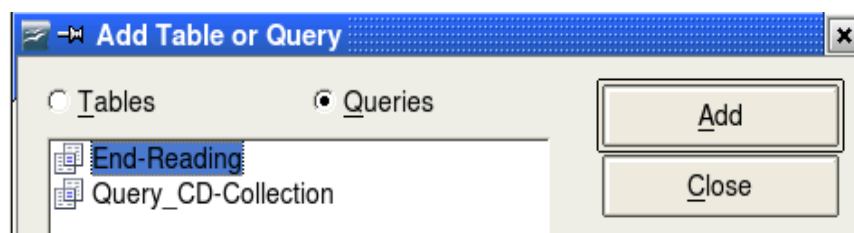

Figure 225: Selecting queries to add to another query

- b) Click End-Reading.
- c) Click **Add**, and then click **Close**.

Step 7: Add fields to the table at the bottom of the query.

We are going to calculate the fuel economy. To do this we need the FuelQuantity and distance traveled. Since the FuelQuantity we want to use is at the ending odometer reading, we will use the End-Reading query to get it. We will also use the Odometer field from the Fuel table and End-Reading query.

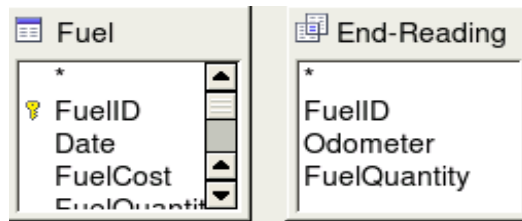

Figure 226: Tables in this query

- 1) Double-click *FuelQuantity* in the End-Reading query.
- 2) Double-click *Odometer* in the End-Reading query.
- 3) Double-click *Odometer* in the Fuel table.

Field	FuelQuantity	Odometer	Odometer
Alias			
Table	End-Reading	End-Reading	Fuel
Sort			
Visible	☒	☒	☒
Function			
Criterion			
Or			

Figure 227: Added fields to the query

Step 8: Enter the FuelID difference field.

We want the difference between the FuelID value of the Fuel table and FuelID value of the End-Reading query to equal one (1).

- 1) Type "End-Reading".FuelID - Fuel.FuelID in the field to the right of the Odometer field of the Fuel Table.

Type the numeral 1 (one) in the Criterion cell of this column.

Field	FuelQuantity	Odometer	Odometer	"End-Reading".FuelID - "Fuel".FuelID
Alias				
Table	End-Reading	End-Reading	Fuel	
Sort				
Visible	☒	☒	☒	☒
Function				
Criterion				1

Figure 228: Typing in calculation of fields

- 2) Calculate the distance traveled:
 - Type "End-Reading".Odometer - Fuel.Odometer in the Field cell.
 - Type >0 in the Criterion cell.

Field	"End-Reading"."Odometer" - "Fuel"."Odometer"
Alias	
Table	
Sort	
Visible	<input checked="" type="checkbox"/>
Function	
Criterion	>0
Or	

Figure 229: Field for distance traveled calculations

3) Calculate fuel economy:

Type ("End-Reading".Odometer – Fuel.Odometer)/"End-Reading".FuelQuantity in the next column to the right of the word Field.

Field	("End-Reading"."Odometer" - "Fuel"."Odometer") / "End-Reading"."FuelQuantity"
Alias	
Table	
Sort	
Visible	<input checked="" type="checkbox"/>
Function	
Criterion	
Or	

Figure 230: Fuel economy calculation field

Note

When entering fields for these calculations, you must follow this format: table or query name followed by a period followed by the field name. For hyphenated or multiple-word names (table or query), use double quotes around the table or query name. The query will then add the rest of the double quotes as in Figure 230.

Use the arithmetical symbol between the two. More than one calculation can be done by using parentheses to group the arithmetical operations.

Step 9: Run the query and make some modification.

After we run the query to make sure it works correctly, we will hide all of the fields that we do not need.

1) Click the Run Query icon in the Design Query toolbar (Figure 223). The results are in Figure 231.

FuelQuantity	Odometer	Odometer1	"End-Reading"."FuelID" - "Fuel"."FuelID"	Distance	("End-Reading"."Odometer" - "Fuel"."Odometer") / "End-Reading".
6.430	778.7	704.2	1	74.5	11.59
19.570	1032.3	778.7	1	253.6	12.96
15.150	1239.4	1032.3	1	207.1	13.67

Figure 231: Result of running the fuel economy query

Notice that not all of the last column label is visible because some of the labels are long. We can fix this problem by using an alias for many of the fields. The labels are replaced by their aliases.

2) Add Aliases:

Type in the aliases as they are listed in Figure 232.

FuelQuantity	Odometer	Odometer	"End-Reading"	("End-Reading"."
Quantity	Begin	End		Fuel Economy
End-Reading	End-Reading	Fuel		

Figure 232: Query table with aliases added

3) Run the query again. The results are in Figure 233.

Quantity	Begin	End	"End-Reading"."FuelID" - "Fuel"."FuelID"	Distance	Fuel Economy
6.430	778.7	704.2	1	74.5	11.59
19.570	1032.3	778.7	1	253.6	12.96
15.150	1239.4	1032.3	1	207.1	13.67

Figure 233: Query run with aliases

We really do not need the column showing the difference between the FuelID fields from the table and query, so we will hide it. While it will not be visible, it will still be used in the calculations.

4) Hide a field that does not need to be seen.

Remove the check in the box of the Visible cell as in Figure 234.

Field	FuelQuantity	Odometer	Odometer	"End-Reading"."FuelID" - "Fuel"."FuelID"
Alias	Quantity	Begin	End	
Table	End-Reading	End-Reading	Fuel	
Sort				
Visible	<input checked="" type="checkbox"/>	<input checked="" type="checkbox"/>	<input checked="" type="checkbox"/>	<input type="checkbox"/>

Figure 234: Making a field invisible in a query run

5) Rerun the query (Figure 235).

Quantity	Begin	End	Distance	Fuel Economy
6.430	778.7	704.2	74.5	11.59
19.570	1032.3	778.7	253.6	12.96
15.150	1239.4	1032.3	207.1	13.67

Figure 235: Query run with aliases

Step 10: Close, save, and name the query.

My suggestion for a name is *Fuel Economy*.

There are obviously other calculations that can be made in this query such as cost per distance traveled and how much of the cost belongs to each of the payments types.

Note

To fully use queries requires a knowledge of set operations (*unions, intersections, and, or, complements*, and any combinations of these). Having a copy of the *Hsqldb User Guide*, available from <http://hsqldb.org/>, is also extremely useful.

Creating reports

Reports provide information found in the database in a useful way. In this they are similar to queries. Reports are generated from the database's tables or queries. They can contain all of the fields of the table or query or just a selected group of fields. Reports can be static or dynamic. Static reports contain the data in the selected fields at the time the report was created. Dynamic reports can be updated to show the latest data.

For example, a report on expenses for a vacation in the past should probably be a static report because it is based upon specific data that does not change. However, a report on the fuel data should probably be a dynamic report, because this report depends upon data that does change.

Caution



Dynamic reports update only the *data* that is changed or added to a table or query. They do **not** show any modifications made to the table or query itself. For example, **after** creating the report below, open the fuel economy query created in the previous section. For the "End-Reading"."Odometer - Fuel."Odometer" column, change the number 1 to the number 3. The report will be identical before and after you make the change.

All reports are based upon a single table or query. So you need first to decide what fields you want to use in the report. If you want to use fields from different tables, you must first combine these fields in a single query. Then you can create a report on this query.

For example, a report on vacation expenses includes both fuel costs and meal costs. These values are contained in fields of two different tables: Vacations and Fuel. So this report requires creating a query.

Creating a static report

We will create a report on vacation expenses. Certain questions need to be asked before creating the report.

- What information do we want in the report?
- How do we want the information arranged?
- What fields are required to provide this information?
- Will a query have to be created because these fields are in different tables?
- Are there any calculations required in the data before being added to the report?

The expenses for our vacation are motel, tolls, miscellaneous, breakfast, lunch, supper, snacks, and fuel. One possible report would simply list the totals of each of these expense groups. Another possible report would list the expense totals for each day of the vacation. A third possible report would list the totals for each expense group for each type of payment. (This would let us know where the money came from to pay the expenses.) The best way to create reports like these is to create the queries needed to gather the needed data, insert the query data into a spreadsheet, and use the necessary Calc functions on this data.

We will create two reports, one listing the expenses each day other than fuel and the second listing the fuel costs each day.

The fields we need for the first report from the Vacations table are: Date, Motel, Toll, Breakfast, Lunch, Supper, SnackCost, and Miscellaneous. This report will not require an additional query.

The second report involves the Fuel table. Since this table includes fuel purchases at times other than during the vacation, we need to create a query that contains only the fuel purchased during the vacation.

Vacations table report

To create a new report.

- 1) Click the *Reports* icon in the Database list in the Automobile - OpenOffice.org Base window (Figure 175).
- 2) In the Tasks list, click **Use Wizard to Create Report**. The Report Wizard opens.

Step 1: Field selection

- 1) Select *Table: Vacations* in the Tables or Queries dropdown list.
- 2) Use the > to move these fields from the *Available fields* list to the *Fields in report* list: Date, Motel, Tolls, Miscellaneous, Breakfast, Lunch, Supper, and SnackCost. Click **Next**.

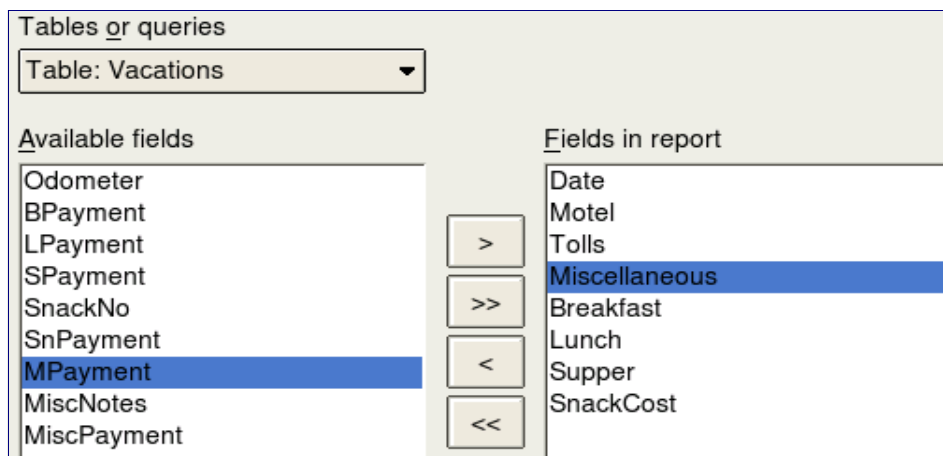

Figure 236: Adding fields to a report

Step 2: Labeling fields

Change any field labels you wish. We will shorten Miscellaneous to Misc. Click **Next**.

Step 3: Grouping

Since we are grouping by the date, use the > button to move the *Date* field to the Grouping list. Click **Next**.

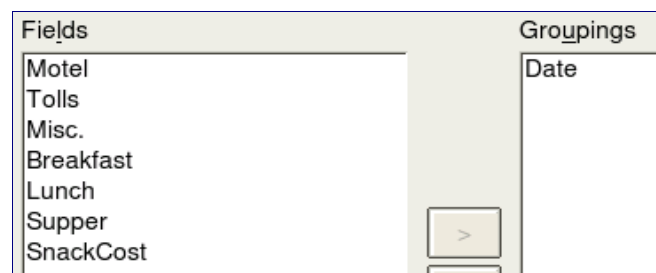

Figure 237: Selecting fields for grouping data

Step 4: Sort options

We do not want to do any additional sorting. Click **Next**.

Step 5: Choose layout

Use default settings for the layout. Click **Next**.

Step 6: Create report

- Label the report: Vacation Expenses.
- Select Static report.
- Click **Finish**.

Note If you feel adventurous, try selecting some of the other layout choices. After selecting a choice, drag the Report Wizard window out of the way so that you can see what you have selected. (Move the cursor over the Title Bar of the window, and then drag and drop.)

Vacation fuel report

- 1) Create a query containing only fuel bought on the days of the vacation.
 - a) Open a query in Design View.
 - b) Follow the steps for adding tables in “Add tables” on page 240 to add the Fuel table.
 - c) In the Fuel table, double-click *Date* and *FuelCost* to enter them in the table at the bottom of the query.
 - d) In the Criterion cell of the Date field, type the following: BETWEEN #5/25/2007# AND #5/26/2007#

Field	Date	FuelCost
Alias		
Table	Fuel	Fuel
Sort		
Visible	<input checked="" type="checkbox"/>	<input checked="" type="checkbox"/>
Function		
Criterion	BETWEEN #05/25/2007# AND #05/26/2007#	

Figure 238: Setting the criterion for a query

- 2) Save, name, and close the query. (Suggestion: *Vacation Fuel Purchases*.)

Tip When using dates in a query, enter them in numerical form MM/DD/YYYY or DD/MM/YYYY depending upon your language's default setting for dates (my default setting is MM/DD/YYYY). Each date must have a # before and after it. Hence, May 25, 2007 is written #05/25/2007# or #25/5/2007# depending upon your language's default setting for dates.

- 3) Open a new report.
 - Right-click the *Vacation Fuel Purchases* query.
 - Select Report Wizard from the pop-up menu.

Note When a new report is opened in this way, the query used to open it is automatically selected in the Tables or queries dropdown list in the Report Wizard.

- 4) Create the report.
Use >> to move both fields from the *Available fields* list to the *Fields in report* list. Click **Next**.
- 5) Label fields.
Add a space to FuelCost to make it Fuel Cost (two words). Click **Next**.
- 6) Group fields.
Click Date to highlight it. Use > to move the Date field to the Groupings list. Click **Next**.
- 7) Choose layout.
We will be making no changes in the layout. Click **Next**.
- 8) Create report (final settings).
 - Use the suggested name, which is the same as the query.
 - Select Static report. Click **Finish**.

Creating a dynamic report

Now we will create a report with some statistics on our fuel consumption. To do this, we have to modify two queries: End-Reading and Fuel Economy. We will be adding the FuelCost field to the End-Reading query. Then we will add the FuelCost field from the End-Reading query to the Fuel Economy query.

Tip When opening a query to edit it, it might appear as in Figure 239. If you move your cursor over the black line (circled), it becomes a double headed arrow. Drag it to a lower position.

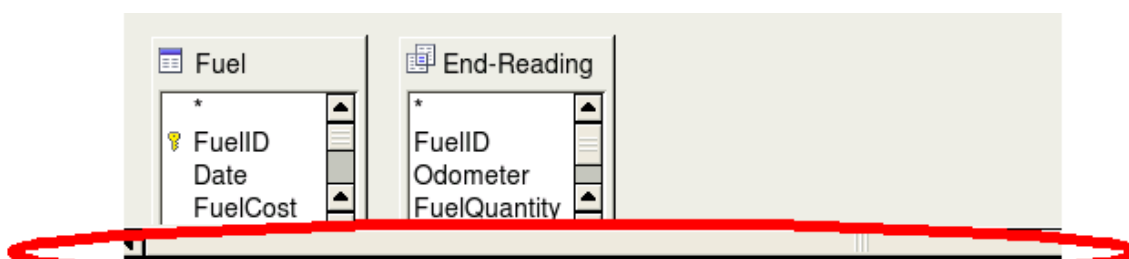

Field	Date	FuelQuantity	Odometer	Odometer	"End-Reading
Alias		Quantity	Begin	End	Distance
Table	Fuel	End-Reading	Fuel	End-Reading	
Sort					
Visible	<input checked="" type="checkbox"/>	<input checked="" type="checkbox"/>	<input checked="" type="checkbox"/>	<input checked="" type="checkbox"/>	<input checked="" type="checkbox"/>
Function					
Criterion					> 0

Figure 239: Appearance of query when opened for editing

- 1) Add the *FuelCost* field to the End-Reading query:
 - a) Right-click the *End-Reading* query and select **Edit** from the pop-up menu.

- b) In the Fuel table list, double-click to add *FuelCost* to the bottom table (Figure 240).
- c) Save and close the query.

FuelID	Odometer	FuelQuantity	FuelCost
Fuel	Fuel	Fuel	Fuel
✕	✕	✕	✕
> 0			

Figure 240: Adding an additional field to the query

- 2) Add the *FuelCost* field from the End-Reading query to the Fuel Economy query:
 - Right-click the *Fuel Economy* query and select **Edit** from the pop-up menu.
 - Double-click the *FuelCost* field in the End-Reading query list to add it to the query table at the bottom.
- 3) Add a calculation field to the right of the FuelCost field.
 - Type the following in a Field cell in the table at the bottom:
"End-Reading".FuelCost/("End-Reading".Odometer – Fuel.Odometer)
 - Type the following in its Alias cell: **cost per mile**.

Note If you use the metric system, **cost per km** is the appropriate alias.

- 4) Save and close the query.
- 5) Open a new report.
Right-click the Fuel Economy query and select **Report Wizard**.
- 6) Select fields.
Move all the fields from the Available fields to the Fields in report list. Use the >> to do so. Click **Next**.
- 7) Label fields.
Change FuelCost to Fuel Cost by placing a space between the words. Click **Next**.
- 8) Group fields.
Use > to move the Date field to the Groupings list. Click **Next**.
- 9) Sort options: the wizard skipped this one.
- 10) Choose layout: accept the default. Click **Next**.
- 11) Create the report.
 - Change the report name to Fuel Statistics.
 - The default setting is Dynamic report, so no change is necessary.
 - Select Modify report layout.
 - Click **Finish**.

Modifying a report

At the end of the last section, we left the Fuel Statistics report open in the edit mode (Figure 241). We will be working on that report. These same steps can be used with any report that you open for editing.

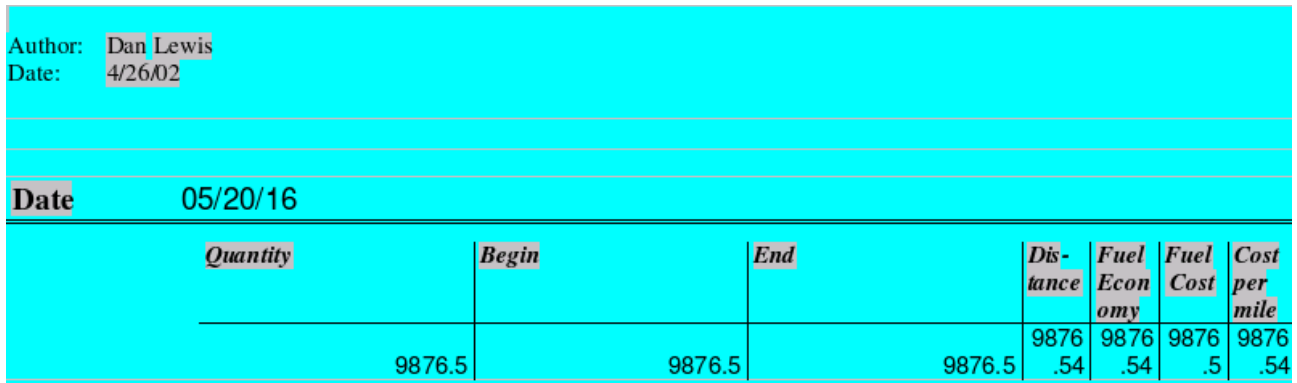

Author: Dan Lewis
Date: 4/26/02

Date: 05/20/16

Quantity	Begin	End	Dis- tance	Fuel Econ- omy	Fuel Cost	Cost per mile
9876.5	9876.5	9876.5	9876 .54	9876 .54	9876 .5	9876 .54

Figure 241: A report in edit mode

The Author is the name you listed in **Tools > Options > OpenOffice.org > User Data**. The date is not correct. The columns need to be moved to the left to give a better appearance. None of the numbers are correct, but their only purpose is to show the number of decimal places.

Step 1: Change the date.

- 1) Click to the right of the date (4/26/20) so that the cursor is next to the field. Use the *Backspace* key to erase the date.
- 2) **Insert > Fields > Date**. This places today's date where the original date was.
- 3) Change the date formatting:
 - a) Double-click the date field you just inserted. The Edit Fields: Document window opens (Figure 242).

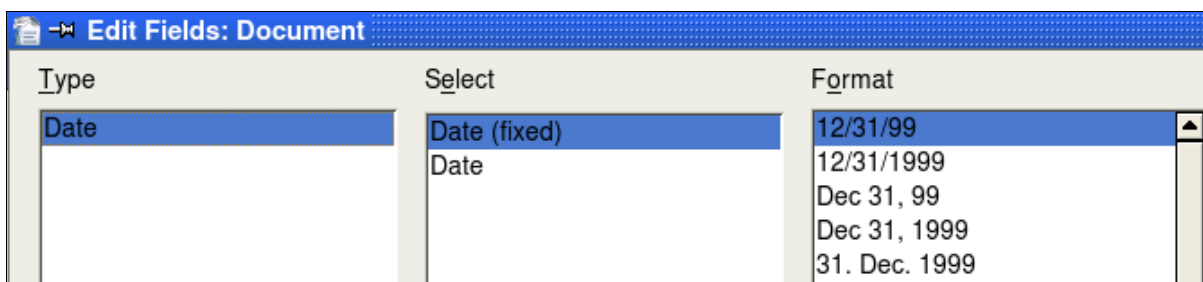

Figure 242: Modifying a date field

- b) Since this is a dynamic report, change the Select field from Date (fixed) to Date.
- c) Change the Format to what you desire. (I use the Friday, December 31, 1999 choice.) Click **OK**.

Step 2: Change the column widths.

The column widths can be changed by moving the cursor over the right border of each column so that it becomes a double-headed arrow. Then drag and drop it to where you want it. This has to be done for each column in each table in the report.

This can also be done with the last column on the right even though there is no black border. It should now look something like Figure 243.

Author: Dan Lewis						
Date: Thursday, May 31, 2007						
Date 05/20/16						
Quantity	Begin	End	Distance	Fuel Economy	Fuel Cost	Cost per mile
9876.5	9876.5	9876.5	9876.54	9876.54	9876.5	9876.54

Figure 243: Realigned columns in a report

Step 3: Change the number formatting in the cells.

The fuel quantity should have three decimal places. The Begin, End, and Distance should have one decimal place. Fuel Cost should be currency and have two decimal places, and Cost per mile should have three decimal places.

- 1) Right-click the cell below Quantity and select **Number format**. (The cell is circled in Figure 243.)
- 2) In the *Options* section (Figure 244),
 - a) Change the number of Decimal places to 3.
 - b) Click the green checkmark. Click **OK**.

Figure 244: Option section of the Number Formatting window

- 3) Change the Cost per mile field.
 - a) Right-click in the cell below *Fuel Cost*.
 - b) Select **Number Format**.
 - c) In the Category list, select *Currency*. Click **OK**.
- 4) Change the Fuel Cost field.
 - a) Right-click in the cell below *Cost per mile*.
 - b) Select **Number Format**.
 - c) In the Category list, select *Currency*.
 - d) In the Option section:
 - Set the number of decimal places to 3.
 - Click the green checkmark.
 - e) Click **OK**.

Step 4: Save and close the report.

Double-click the report. It should now look like Figure 245.

Title:

Author: Dan Lewis
Date: 4/26/02

Date Friday, May 25, 2007

Motel	Tolls	Misc.	Breakfast	Lunch	Supper	SnackCost
\$50.00		\$2.00	\$11.00	\$15.00	\$13.00	\$5.00

Date Saturday, May 26, 2007

Motel	Tolls	Misc.	Breakfast	Lunch	Supper	SnackCost
\$48.00	\$4.00		\$13.00	\$10.00	\$15.00	\$7.00

Date Sunday, May 27, 2007

Motel	Tolls	Misc.	Breakfast	Lunch	Supper	SnackCost

Figure 245: Final report

More ways to create reports

An extension is available to assist in report creation. *Sun Report Builder* creates stylish, complex database reports. You can define group and page headers, group and page footers, and calculation fields. It is available from <http://extensions.services.openoffice.org/>.

To install this extension, follow these steps:

- 1) Choose **Tools > Extension Manager** from the menu bar. In the Extension Manager dialog, click **Get more extensions online....**
- 2) The OOO extensions page opens in your browser. Find and select the extension you want and follow the prompts to install it. During installation, you will be asked to accept a license agreement.
- 3) When the installation is complete, the extension is listed in the Extension Manager dialog.

For more about extensions, see Chapter 14 (Customizing OpenOffice.org).

Chapter 9

Getting Started with Math

OpenOffice.org's Equation Editor

What is Math?

Math is OpenOffice.org's component for writing mathematical equations. It is most commonly used as an equation editor for text documents, but it can also be used with other types of documents or stand-alone. When used inside Writer, the equation is treated as an object inside the text document.

Note The equation editor is for writing equations in symbolic form, as in equation 1. If you want to evaluate a numeric value, see the *Calc Guide*.

$$\frac{df(x)}{dx} = \ln(x) + \tan^{-1}(x^2) \quad (1)$$

Getting started

To insert an equation, choose **Insert > Object > Formula**.

The equation editor opens at the bottom of the screen, and the floating Elements window (called "Selection" before Math 3.2 and "Formula Elements" in Math 3.2) may appear. You will also see a small box with a gray border in your document, where the formula will be displayed.

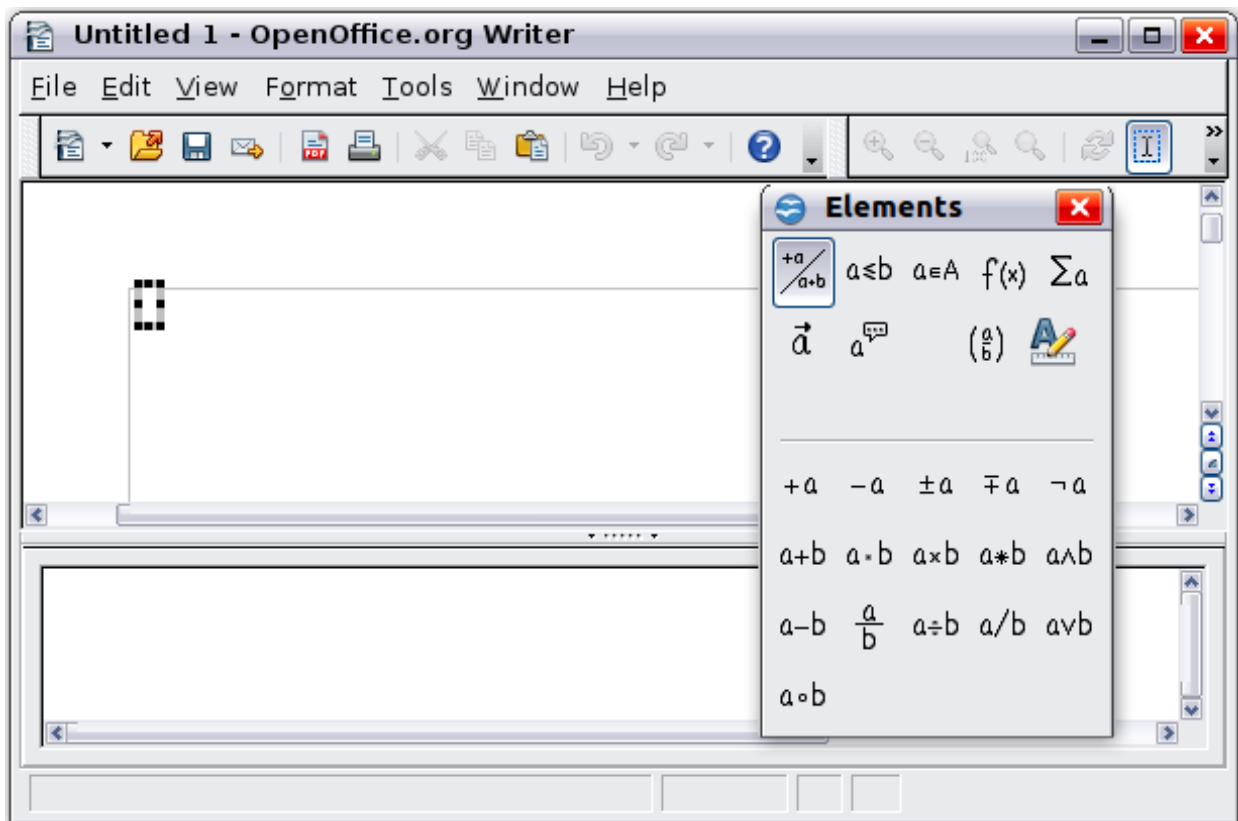

Figure 246: Equation Editor, Elements window, and location of resulting equation.

Entering a formula

The equation editor uses a markup language to represent formulas. For example, `%beta` creates the Greek character beta (β). This markup is designed to read similar to English whenever possible. For example, `a over b` produces a fraction: $\frac{a}{b}$.

You can enter a formula in three ways:

- Select a symbol from the Elements window.
- Right-click on the equation editor and select the symbol from the context menu.
- Type markup in the equation editor.

The context menu and the Elements window insert the markup corresponding to a symbol. This provides a convenient way to learn the Math markup.

Note

Click on the document body to exit the formula editor.

Double-click on a formula to enter the formula editor again.

The Elements window

The simplest method for entering a formula is to use the Elements window.

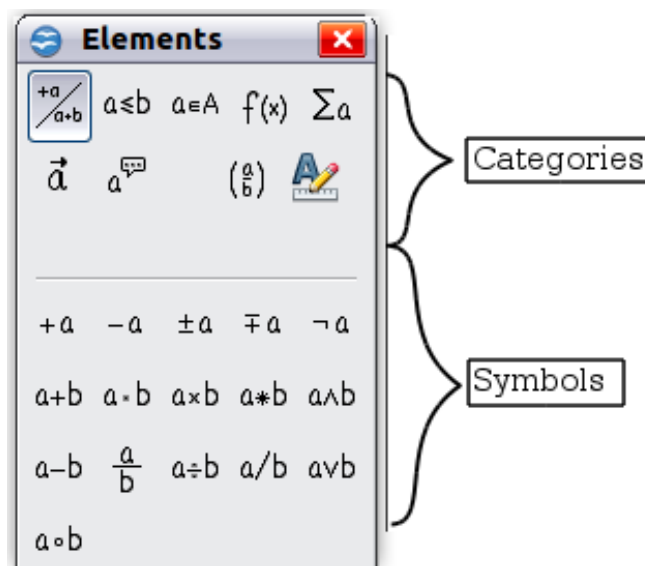

Figure 247: Symbols are divided into categories

The Elements window is divided into two main parts.

- The **top** shows the symbol categories. Click on these to change the list of symbols.
- The **bottom** shows the symbols available in the current category.

Tip

You can hide or show the Elements window with **View > Elements**.

Example 1: 5×4

For this example we will enter a simple formula: 5×4 . On the Elements window:

- 1) Select the top-left button of the categories (top) section.
- 2) Click on the multiplication symbol.

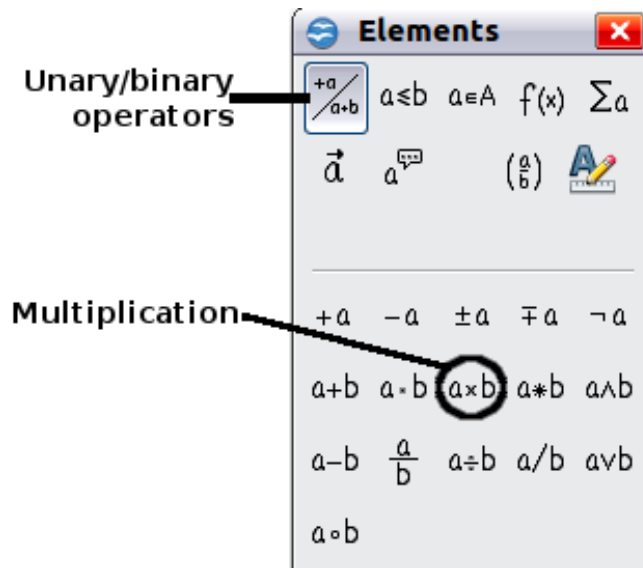

Figure 248: Selecting the multiplication symbol

When you select the multiplication symbol on the Elements window, two things happen:

- The equation editor shows the markup: $\langle ? \rangle \text{ times } \langle ? \rangle$
- The body of the document shows a gray box like this: $\square \times \square$

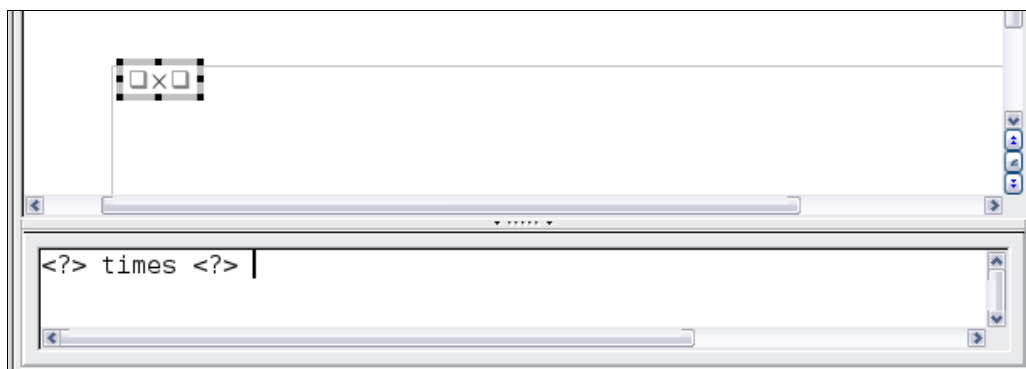

Figure 249: Result of selecting the multiplication symbol

The $\langle ? \rangle$ symbols shown in Figure 249 are placeholders that you can replace by other text, for example 5 and 4. The equation will update automatically, and the result should resemble Figure 250.

Tip To keep the equation from updating automatically, choose **View > AutoUpdate display** from the menu bar. To update a formula manually, press *F9* or choose **View > Update**.

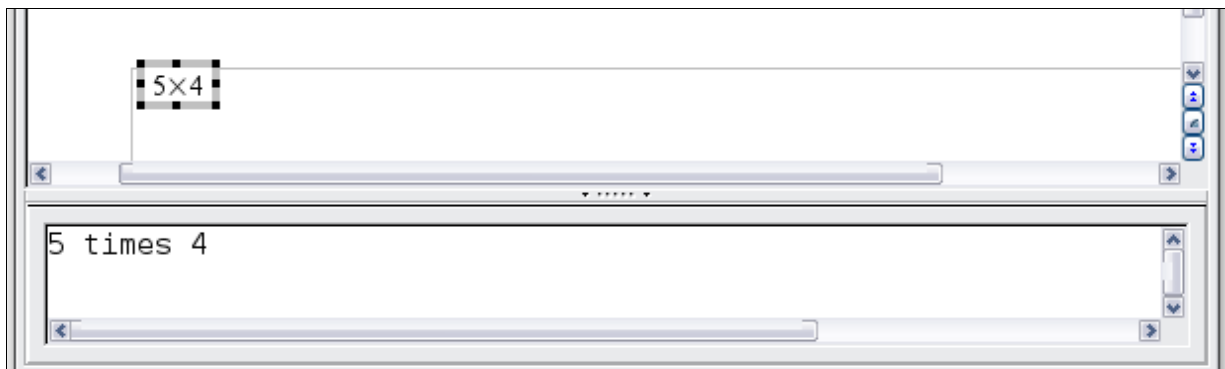

Figure 250: Result of entering 5 and 4 next to the times operator

Right-click menu

Another way to access mathematical symbols is to right-click on the equation editor. This pops up the menu shown in Figure 251. The items in this menu correspond exactly to those in the Elements window.

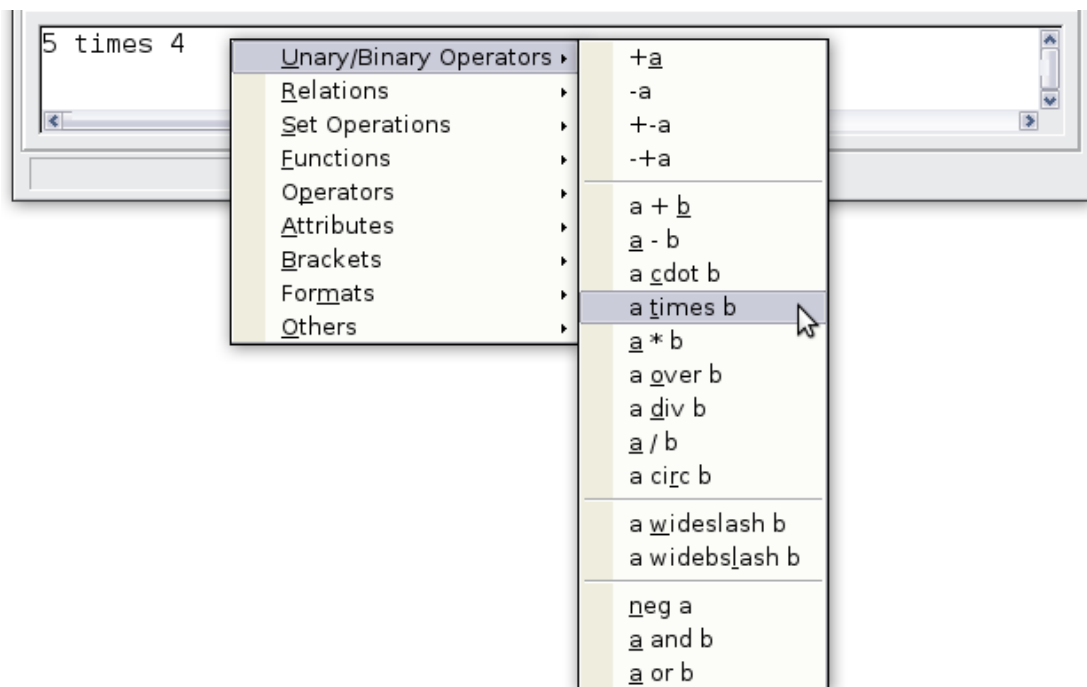

Figure 251: Right-click menu

Markup

You can type the markup directly in the equation editor. For example, you can type 5 times 4 to obtain 5×4 . If you know the markup, this can be the fastest way to enter a formula.

Tip The formula markup resembles the way the formula reads in English.

Below is a short list of common equations and their corresponding markup.

Display	Command	Display	Command
$a=b$	a = b	\sqrt{a}	sqrt {a}
a^2	a^2	a_n	a_n
$\int f(x) dx$	int f(x) dx	$\sum a_n$	sum a_n
$a \leq b$	a <= b	∞	infinity
$a \times b$	a times b	$x \cdot y$	x cdot y

Greek characters

Greek characters (α , β , γ , θ , and so on) are common in mathematical formulas. *These characters are not available in the Elements window or on the right-click menu.* Fortunately, the markup for Greek characters is simple: Type a % sign followed the name of the character, in English. (In localized versions of OpenOffice.org, these names are localized.)

- To write a *lowercase* character, type the name of the character in lowercase.
- To write an *uppercase* character, type the name of the character in uppercase.

See the table below for some examples.

Lowercase	Uppercase
%alpha → α	%ALPHA → A
%beta → β	%BETA → B
%gamma → γ	%GAMMA → Γ
%psi → ψ	%PSI → Ψ
%phi → ϕ	%PHI → Φ
%theta → θ	%THETA → Θ

Note A complete table of Greek characters is provided in the *Math Guide*.

Another way to enter Greek characters is by using the Symbols catalog window. Choose **Tools > Catalog**. Under *Symbol set*, select **Greek** and double-click on a Greek letter from the list. The markup name of the character is shown below the list window.

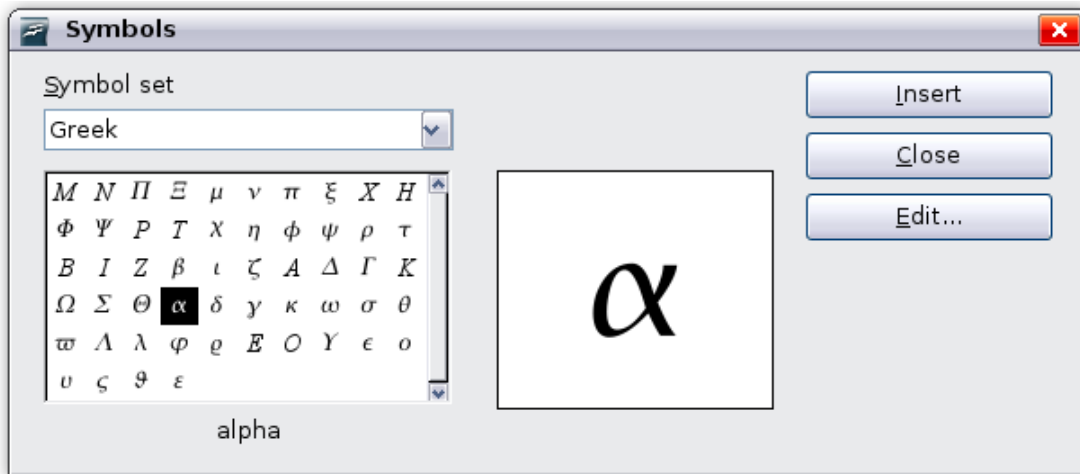

Figure 252: Symbols catalog—used for entering Greek characters and some special symbols.

Example 2: $\pi \simeq 3.14159$

For this example we will suppose that:

- We want to enter the above formula (the value of pi rounded to 5 decimal places).
- We know the name of the Greek character (pi).
- But we do not know the markup associated with the \simeq symbol.

Step 1: Type % followed by the text pi. This displays the Greek character π .

Step 2: Open the Elements window (**View > Elements**).

Step 3: The \simeq symbol is a relation, so we click on the Relations button. If you hover the mouse over this button you see the tooltip *Relations* (Figure 253).

Figure 254 shows the Elements window after clicking the Relations button. The symbol we want is circled.

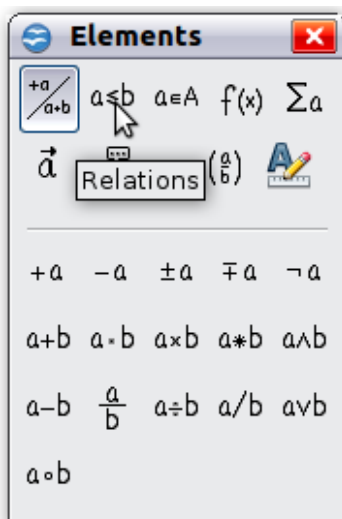

Figure 253: Tooltip indicates the Relations button

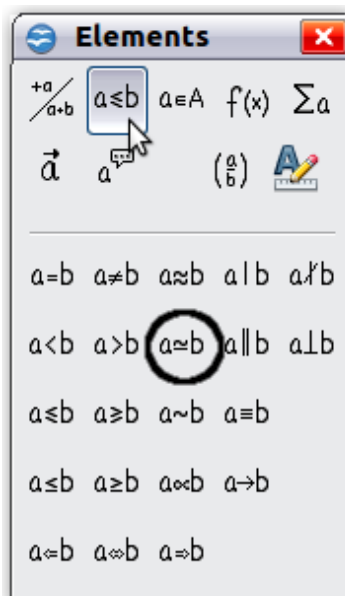

Figure 254: After selecting Relations

Step 4: Click on the $a \simeq b$ symbol. The equation editor now shows the markup `%pi<?> simeq <?>`.

Step 5: Delete the `<?>` text and add 3.14159 at the end of the equation. We end up with the markup `%pi simeq 3.14159`. The result is shown in Figure 255.



Figure 255: Final result

Customizations

Formula editor as a floating window

The formula editor can cover a large part of the Writer window. To turn the formula editor into a floating window, do this:

- 1) Hover the mouse over the editor frame, as shown in Figure 256.
- 2) Hold down the *Control* key and double-click.

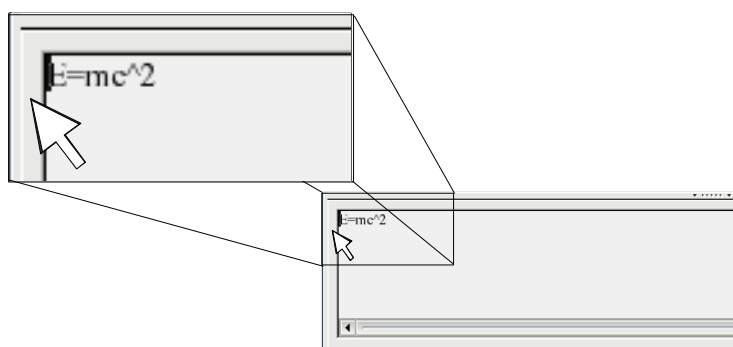

Figure 256: Hold down the *Control* key and double-click on the border of the formula editor to turn it into a floating window.

Figure 257 shows the result. You can dock the floating window again by using the same steps. Hold down the *Control* key and double-click the window frame.

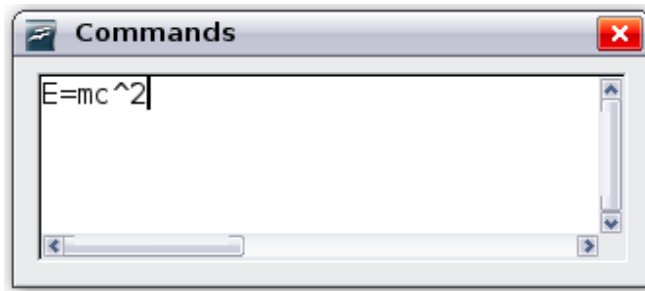

Figure 257: Formula editor as a floating window

How can I make a formula bigger?

This is one of the most common questions people ask about Math. The answer is simple, but not intuitive:

- 1) Start the formula editor and choose **Format > Font size**.

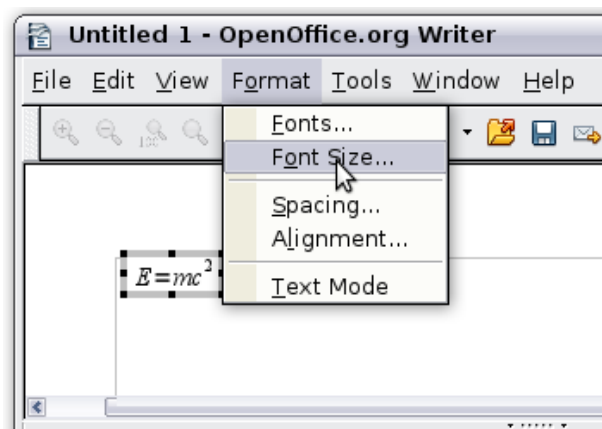

Figure 258: Changing the font size for a formula

- 2) Select a larger font size under *Base size* (top-most entry).

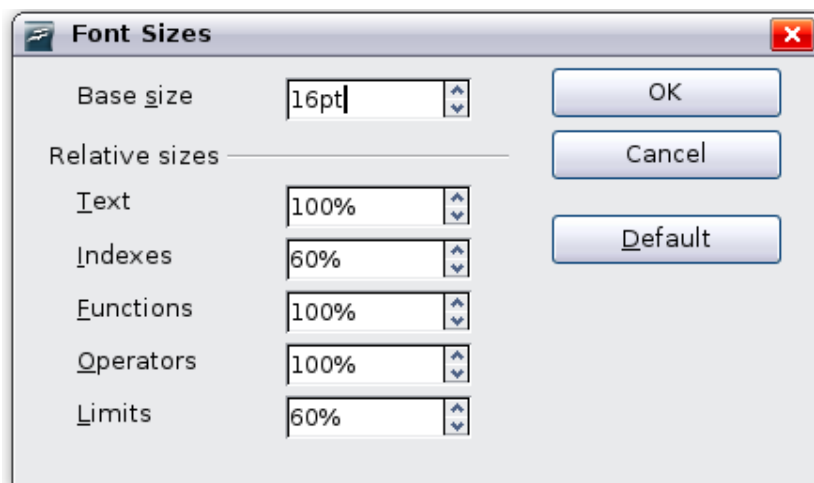

Figure 259: Edit Base size (top) to make a formula bigger.

The result of this change is illustrated in Figure 260.

Before:	$\pi \simeq 3.14159$
After:	$\pi \simeq 3.14159$

Figure 260: Result of changing the base font size.

Formula layout

The most difficult part of using Math comes when writing complicated formulas. This section provides some advice.

Brackets are your friends

Math knows nothing about order of operation. You must use brackets to state the order of operations explicitly. Consider the following example.

Markup	Result
2 over x + 1	$\frac{2}{x} + 1$
2 over {x + 1}	$\frac{2}{x+1}$

Equations over more than one line

Suppose you want to type an equation covering more than one line. For example:

$$x=3$$

$$y=1$$

Your first reaction would be to simply press the *Enter* key. However, if you press the *Enter* key, though the markup goes to a new line, the resulting equation does not. You must type the newline command explicitly. This is illustrated in the table below.

Markup	Result
x = 3 y = 1	x=3 y=1
x = 3 newline y = 1	x=3 y=1

How do I add limits to my sum/integral?

The sum and int commands can (optionally) take the parameters *from* and *to*. These are used for lower and upper limits respectively. These parameters can be used singly or together. Limits for integrals are usually treated as subscripts and superscripts.

Markup	Result
sum from k = 1 to n a_k	$\sum_{k=1}^n a_k$
int from 0 to x f(t) dt or int_0^x f(t) dt	$\int_0^x f(t) dt$ or $\int_0^x f(t) dt$
int from Re f	$\int_{\mathbb{R}} f$
sum to infinity 2^{-n}	$\sum_{n=0}^{\infty} 2^{-n}$

Note For more details on integrals and sums, see the *Math Guide*.

Brackets with matrices look ugly!

For background, we start with an overview of the matrix command.

Markup	Result
matrix { a # b ## c # d }	$\begin{matrix} a & b \\ c & d \end{matrix}$

Note Rows are separated by two #'s and entries within each row are separated by one #.

The first problem people have with matrices is that brackets do not scale with the matrix.

Markup	Result
(matrix { a # b ## c # d })	$\begin{pmatrix} a & b \\ c & d \end{pmatrix}$

Math provides scalable brackets. That is, the brackets grow in size to match the size of their contents. Use the commands *left()* (and *right()*) to make scalable brackets.

Markup	Result
left(matrix { a # b ## c # d } right)	$\left(\begin{matrix} a & b \\ c & d \end{matrix} \right)$

Tip Use *left[* and *right]* to obtain square brackets.

How do I make a derivative?

Making derivatives essentially comes down to one trick: *Tell Math it's a fraction.*

In other words, you have to use the *over* command. Combine this with either the letter *d* (for a total derivative) or the *partial* command (for a partial derivative) to achieve the effect of a derivative.

Note Notice that we have to use braces (squiggly brackets) to make the derivative.

Markup	Result
<code>{df} over {dx}</code>	$\frac{df}{dx}$
<code>{partial f} over {partial y}</code>	$\frac{\partial f}{\partial y}$
<code>{partial^2 f} over {partial t^2}</code>	$\frac{\partial^2 f}{\partial t^2}$

How do I align my equations at the equals sign?

Math does not have a command for aligning equations on a particular character, but you can use a matrix to do this, as shown below.

Markup	Result
<code>matrix{ alignr x+y # {}={ } # alignl 2 ## alignr x # {}={ } # alignl 2-y }</code>	$\begin{array}{rcl} x + y & = & 2 \\ x & = & 2 - y \end{array}$

The empty braces around = are necessary because = is a binary operator and thus needs an expression on each side.

You can reduce the spacing around = if you change the inter-column spacing of the matrix:

- 1) With the equation editor open, choose **Format > Spacing** from the menu bar.
- 2) In the Spacing dialog (Figure 261), click the **Category** button and select **Matrices** in the drop-down menu.
- 3) Enter **0%** for Column spacing and click **OK**.

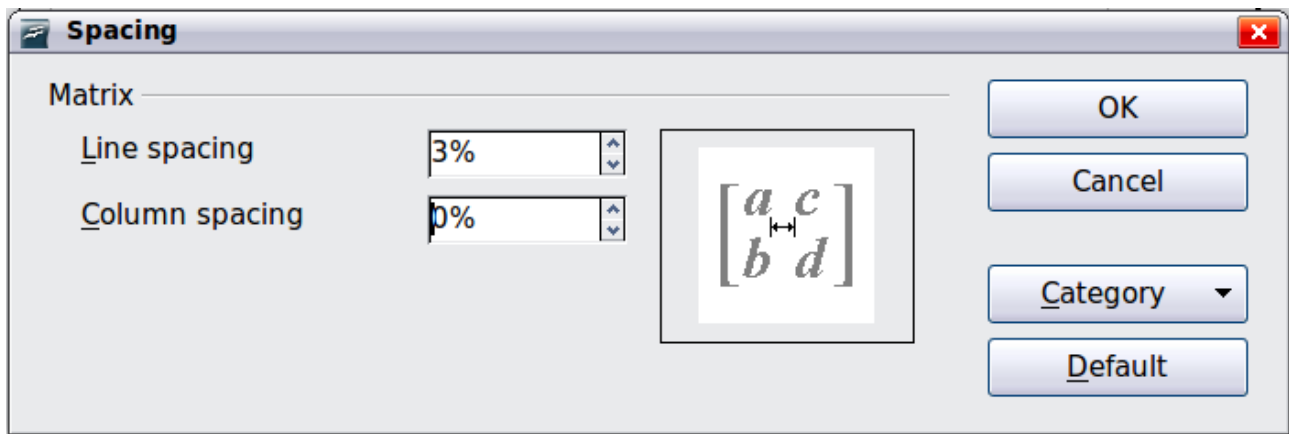

Figure 261: Changing spacing in a matrix formula

Numbering equations

Equation numbering is one of Math’s best hidden features. The steps are simple, but obscure:

- 1) Start a new line.
- 2) Type *fn* and then press *F3*.

The *fn* is replaced by a numbered formula:

$$E = mc^2 \tag{2}$$

Now you can double-click on the formula to edit it. For example, here is the Riemann Zeta function:

$$\zeta(z) = \sum_{n=1}^{\infty} \frac{1}{n^z} \tag{3}$$

You can reference an equation (“as shown in Equation (2)”) with these steps:

- 1) Choose **Insert > Cross-reference** from the menu bar.
- 2) On the *Cross-references* tab (Figure 262), under *Type*, select *Text*.
- 3) Under *Selection*, select the equation number.
- 4) Under *Format*, select *Reference*.
- 5) Click **Insert**.

Done! If you later add more equations to the paper before the referenced equation, all the equations will automatically renumber and the cross-references will update.

Tip To insert the equation number without parenthesis around it, choose *Numbering* instead of *Reference* under *Format*.

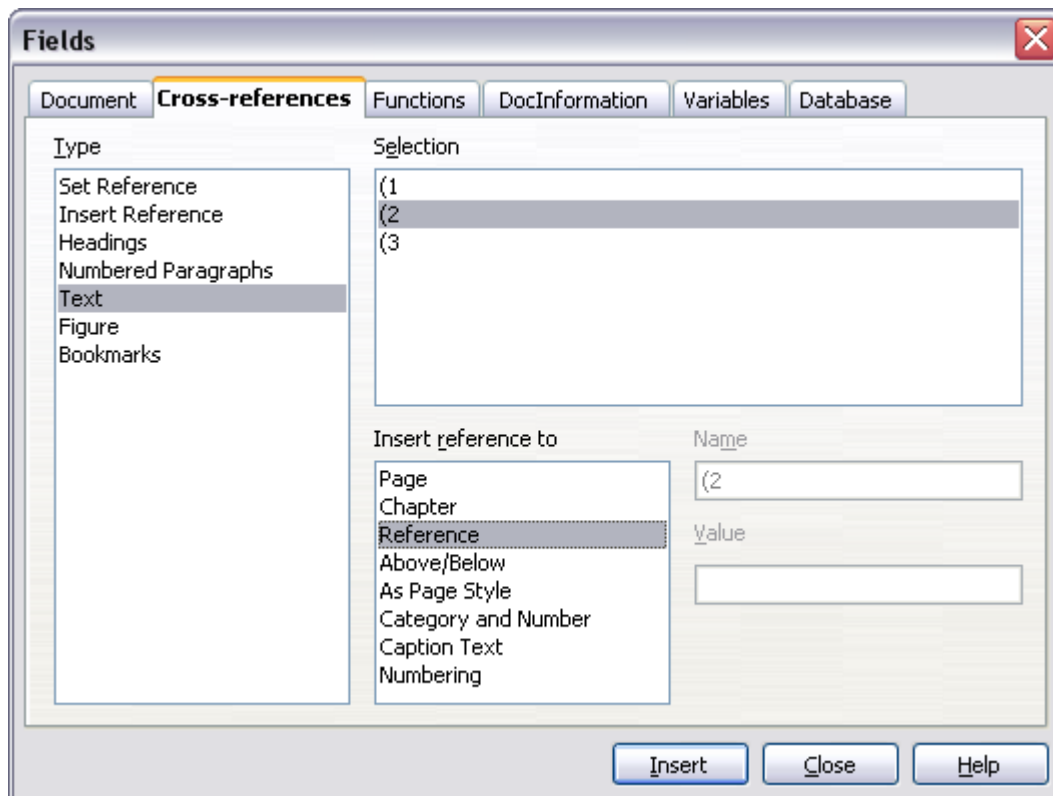

Figure 262: Inserting a cross-reference to an equation number

Chapter 10

Printing, Exporting, and E-mailing

Introduction

This chapter provides general information about printing, exporting, and e-mailing documents from OOo.

Quick printing

Click the **Print File Directly** icon  to send the entire document to the default printer defined for your computer.

Note

You can change the action of the **Print File Directly** icon to send the document to the printer defined for the document instead of the default printer for the computer. Go to **Tools > Options > Load/Save > General** and select the **Load printer settings with the document** option.

Controlling printing

For more control over printing, use the Print dialog (**File > Print** or *Ctrl+P*).

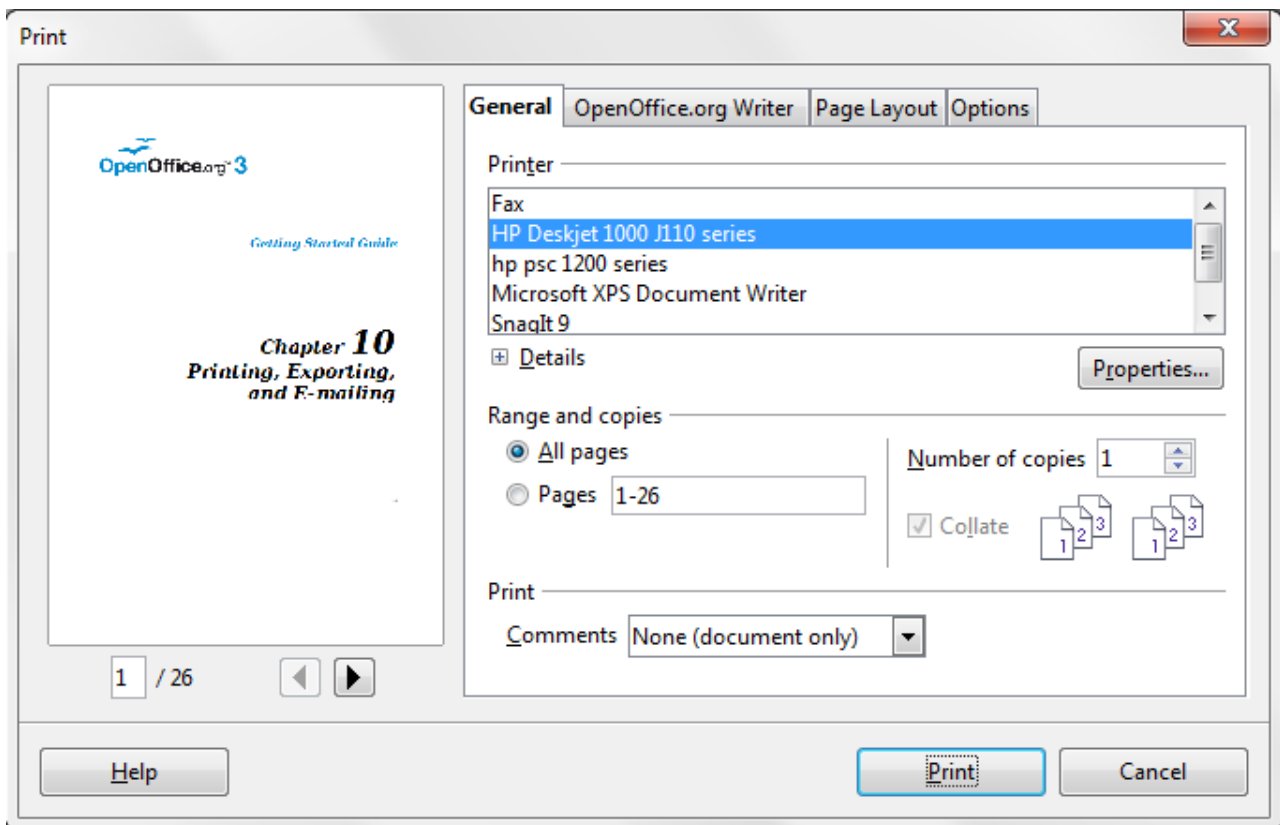

Figure 263. The Print dialog

The Print dialog has four tabs, from which you can choose a range of options, as described in the following sections.

Note The options selected on the Print dialog apply to this printing of this document only.
 To specify default printing settings for OOO, go to **Tools > Options > OpenOffice.org - Print** and **Tools > Options > OpenOffice.org [Component] - Print**. See Chapter 2 (Setting Up OOO) for more details.

The different components of OOO have different available print settings, as summarized in Table 2.

Table 2: Print options in OOO components

Feature	Writer	Calc	Impress	Draw
Select pages/sheets/slides to print	Yes	Yes	Yes	Yes
Print multiple pages/sheets/slides on one page	Yes	Yes	Yes	Yes
Print a brochure	Yes	No	Yes	Yes
Print envelopes	Yes	No	No	No
Print labels or business cards	Yes	No	No	No
Preview pages/sheets before printing	Yes	Yes	No	No

Selecting general printing options

On the *General* tab of the Print dialog, you can choose:

- The **printer** (from the printers available)
- Which **pages** to print, the number of copies to print, and whether to collate multiple copies (*Range and copies* section)
- Whether to print any **comments** that are in the document, and where to print the comments.

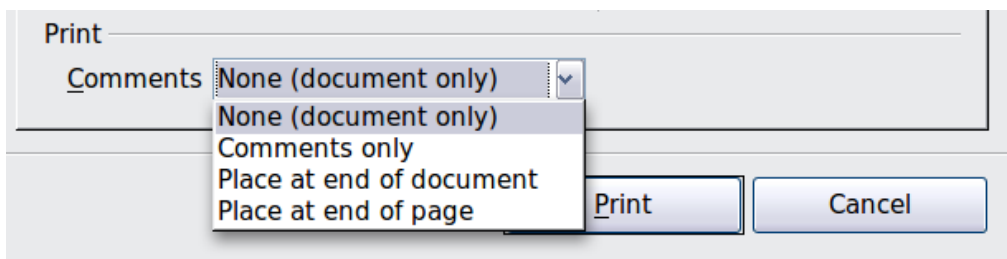

Figure 264: Choosing whether and where to print comments

Select the **Properties** button to display a dialog where you can choose portrait or landscape orientation, which paper tray to use, and the paper size to print on.

On the Options tab of the Print dialog (Figure 265), the last item, *Use only paper tray from printer preference*, is not available in Calc.

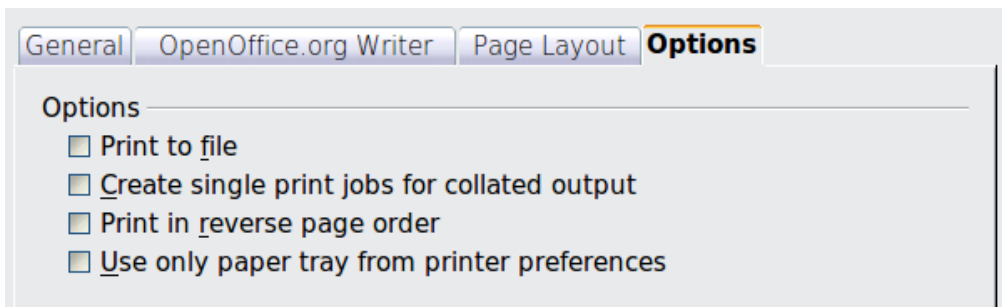

Figure 265: General print options

Printing multiple pages on a single sheet of paper

You can print multiple pages of a document on one sheet of paper. To do this:

- 1) In the Print dialog, select the *Page Layout* tab (Figure 266).

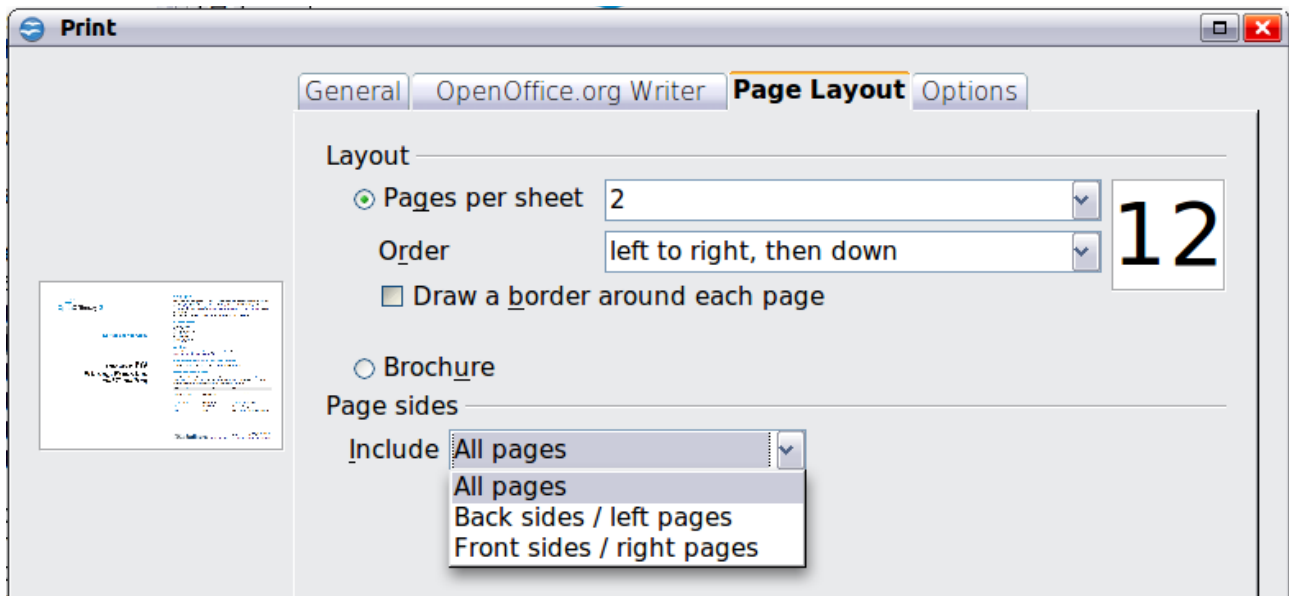
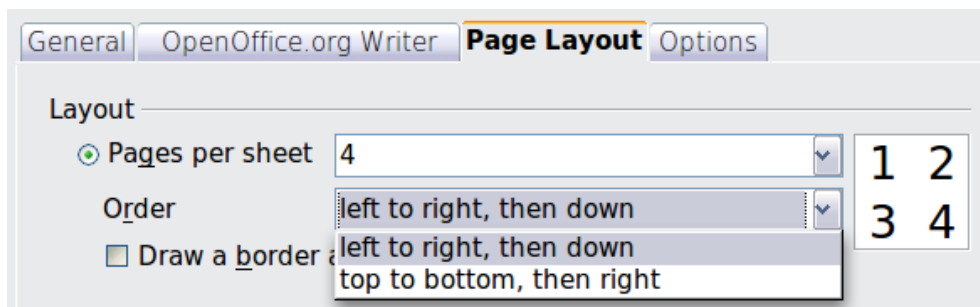
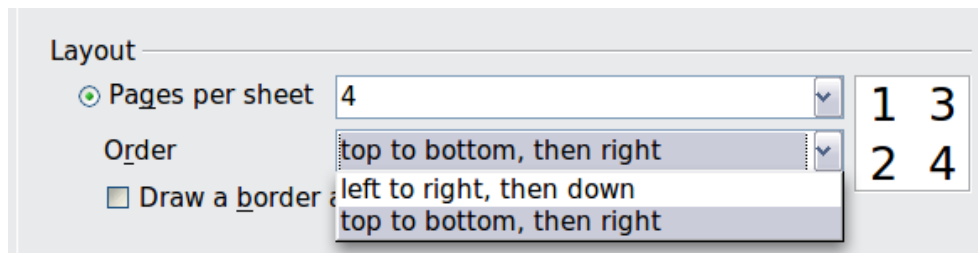

Figure 266: Printing multiple page per sheet of paper

- 2) In the *Layout* section, select from the drop-down list the number of pages to print per sheet. The preview panel on the left of the Print dialog shows how the printed document will look.

When printing more than 2 pages per sheet, you can choose the order in which they are printing across and down the paper. The two pictures below show the difference.





- 3) In the *Page sides* section, select whether to print all pages or only some pages.
- 4) Click the **Print** button.

Tip In Writer, to print two pages per sheet in “facing pages” (book layout) style, print from Print Preview instead. See page 276.

Selecting pages/sheets/slides to print

In addition to printing a full document, you can choose to print individual pages/sheets/slides, ranges of pages/sheets/slides, or a selection of a document. The details vary slightly in Writer, Calc, Draw and Impress, as described in this section.

Writer

Printing an individual page:

- 1) Choose **File > Print** from the menu bar.
- 2) On the Print dialog, select the page to print.
 - a) In the *Ranges and copies* section of the General page, select the *Pages* option.
 - b) Enter the *sequence number* of the page you want to print. The preview box changes to show the selected page.
If you have restarted page numbering within the document, the sequence number is not the same as the page number.
- 3) Click the **Print** button.

Printing a range of pages:

- 1) Choose **File > Print** from the menu bar.
- 2) On the Print dialog, select the range of pages to print.
 - a) In the *Ranges and copies* section of the General page, select the *Pages* option.
 - b) Enter the sequence numbers of the pages to print (for example, 1-4 or 1,3,7,11).
- 3) Click the **Print** button.

Printing a selection of text:

- 1) In the document, select the material (text and graphics) to print.
- 2) Choose **File > Print** from the menu bar.
- 3) The *Ranges and copies* section of the Print dialog now includes a *Selection* option and the preview box shows the selected material. See Figure 267.
- 4) Click the **Print** button.

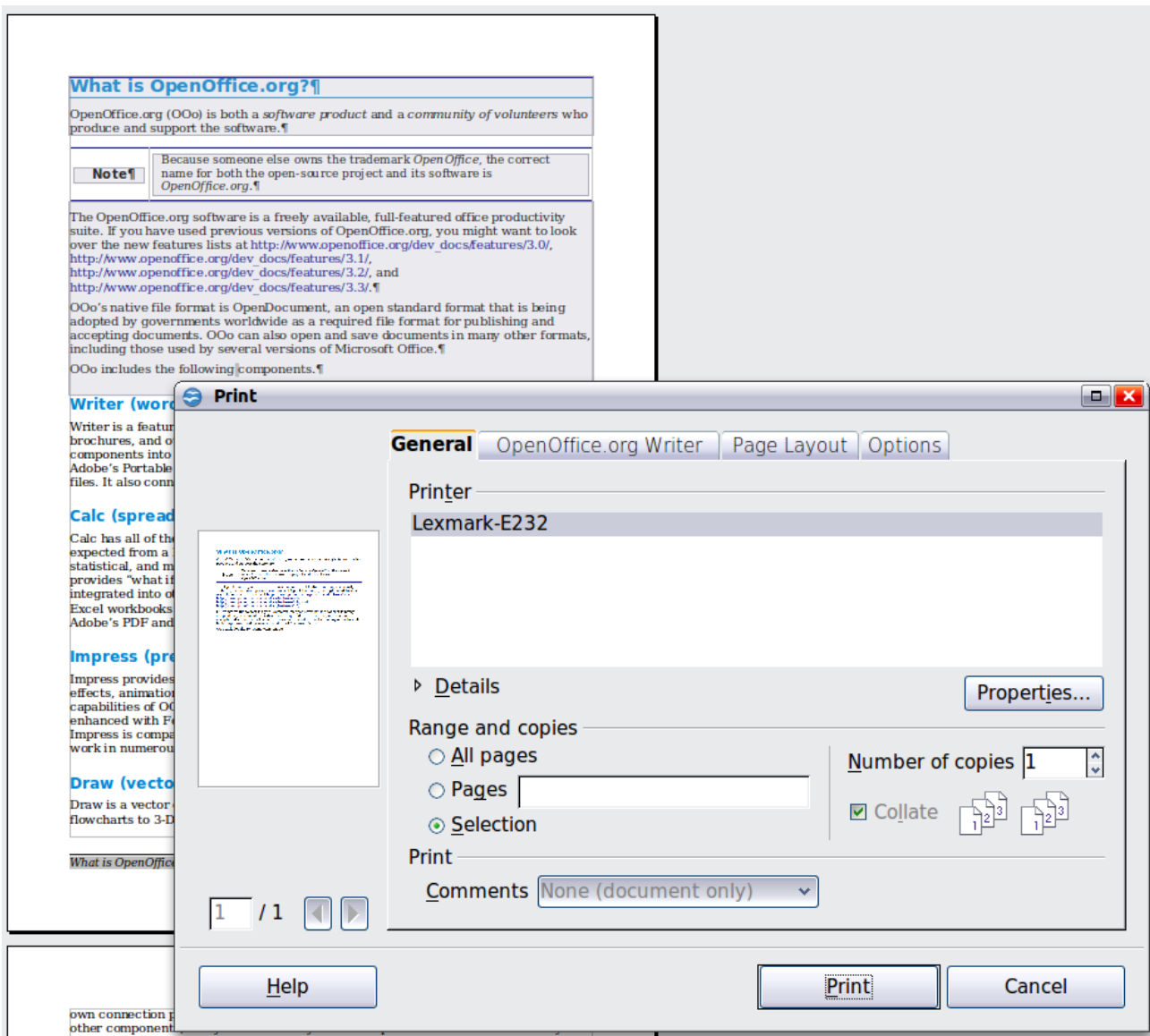

Figure 267: Printing a selection of text

Calc

You can choose single sheets, multiple sheets, and selections of cells for printing.

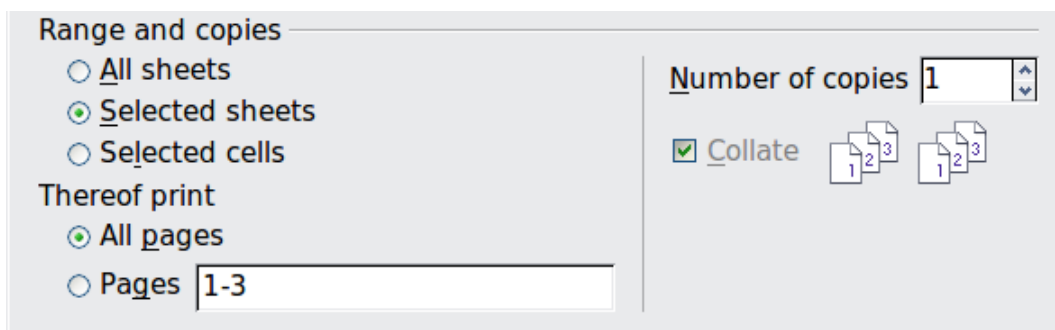

Figure 268: Choosing what to print in Calc

Printing an individual sheet:

- 1) In the spreadsheet, click on the sheet tab to select the sheet you want to print.
- 2) Choose **File > Print** from the menu bar.

- 3) In the *Ranges and copies* section of the Print dialog, choose the *Selected sheets* option.
- 4) Click the **Print** button.

Printing a range of sheets:

- 1) In the spreadsheet, select the sheets to print.
 - a) Select the first sheet.
 - b) Hold down the *Control* key.
 - c) Click on the additional sheet tabs.
 - d) Release the *Control* key when all required sheets are selected.
- 2) Choose **File > Print** from the menu bar.
- 3) In the *Ranges and copies* section of the Print dialog, choose the *Selected sheets* option.
- 4) Click the **Print** button.

Printing a selection of cells:

- 1) In the document, select the section of cells to print.
- 2) Choose **File > Print** from the menu.
- 3) In the *Ranges and copies* section of the Print dialog, select the *Selected cells* option.
- 4) Click the **Print** button.

Caution



After printing, be sure to deselect the extra sheets. If you keep them selected, the next time you enter data on one sheet, you enter data on all the selected sheets. This might not be what you want.

Impress and Draw

You can choose individual slides, ranges of slides, or selections of slides for printing.

The screenshot shows the 'Print' dialog box with the following settings:

- Range and copies:**
 - All slides
 - Slides
 - Selection
- Number of copies:**
- Collate
- Print:**
 - Document:**
 - Slides per page:**
 - Order:**

Printing an individual slide:

- 1) Choose **File > Print** from the menu bar.
- 2) Select the slide to print.
 - a) In the *Ranges and copies* section of the Print dialog, select the *Slides* option.
 - b) Enter the number of the slide to print.
- 3) Click the **Print** button.

Printing a range of pages:

- 1) Choose **File > Print** from the menu bar.
- 2) Select the slides to print.
 - a) In the *Ranges and copies* section of the Print dialog, select the *Slides* option.
 - b) Enter the number of the slides to print (for example 1-4 or 1,3,7,11).
- 3) Click the **Print** button.

Printing a selection of a slide, or a selection from multiple slides:

- 1) In the document, select the section of the slide to print.
- 2) Choose **File > Print** from the menu bar.
- 3) Select the *Selection* option in the *Ranges and copies* section of the Print dialog.
- 4) Click the **Print** button.

Printing handouts, notes, or outlines in Impress

Handouts prints the slides in reduced size on the page, from one to nine slides per page. The slides can be printed horizontally (landscape orientation) or vertically (portrait orientation) on the page.

Notes prints a single slide per page with any notes entered for that slide in Notes View.

Outline prints the title and headings of each slide in outline format.

To print handouts, notes, or outlines:

- 1) Choose **File > Print** from the menu bar.
- 2) In the *Print* section of the Print dialog, select the required option.
- 3) For Handouts, you can then choose how many slides to print per page, and the order in which they are printed.
- 4) Click the **Print** button.

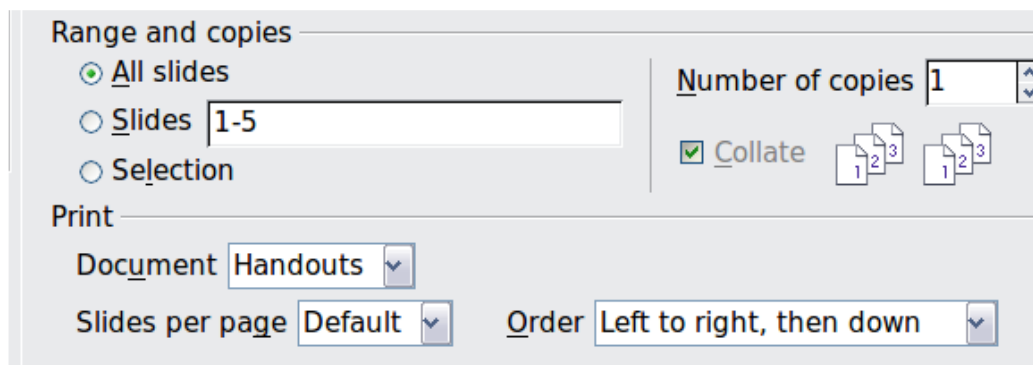

Printing a brochure

In Writer, Impress, and Draw, you can print a document with two pages on each side of a sheet of paper, arranged so that when the printed pages are folded in half, the pages are in the correct order to form a booklet or brochure.

Tip Plan your document so it will look good when printed half size; choose appropriate margins, font sizes, and so on. You may need to experiment.

To print a brochure on a single-sided printer:

- 1) Choose **File > Print**.
- 2) In the Print dialog, click **Properties**.
- 3) Check the printer is set to the same orientation (portrait or landscape) as specified in the page setup for your document. Usually the orientation does not matter, but it does for brochures. Click **OK** to return to the Print dialog.
- 4) Select the *Page layout* tab in the Print dialog.
- 5) Select the **Brochure** option.
- 6) In the *Page sides* section, select *Back sides / left pages* option from the Include drop-down list.

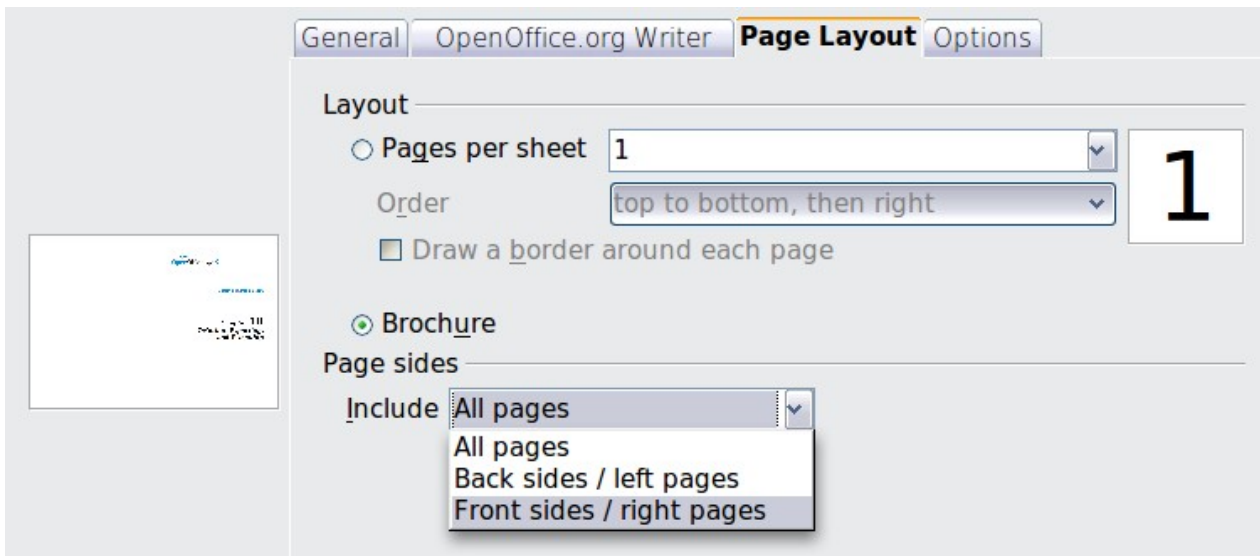

- 7) Click the **Print** button.
- 8) Take the printed pages out of the printer, turn the pages over, and put them back into the printer in the correct orientation to print on the blank side. You may need to experiment a bit to find out what the correct arrangement is for your printer.
- 9) On the Print dialog, in the *Page sides* section, select *Front sides / right pages* option from the Include drop down box.
- 10) Click the **Print** button.

Tip If your printer can print double-sided automatically, choose **All pages**.

Printing envelopes, labels, business cards

Printing envelopes, labels, or business cards using Writer involves two steps: setup and printing.

For details of how to set these up, see Chapter 11 (Using Mail Merge) in the *Writer Guide*. To print:

- 1) Choose **File > Print** from the menu bar.
- 2) On the Print dialog, under *Ranges and copies*, choose **Pages** and type 1 in the box. Click the **Print** button.

Printing in black and white (on a color printer)

You may wish to print documents in black and white on a color printer. Several choices are available. Please note that some color printers may print in color regardless of the settings you choose.

Change the printer settings to print in black and white or grayscale:

- 1) Choose **File > Print** to open the Print dialog.
- 2) Click **Properties** to open the Properties dialog for the printer. The available choices vary from one printer to another, but you should find options for the Color settings. See your printer's help or user manual for more information.
- 3) The choices for color might include *black and white* or *grayscale*. Choose the required setting.
- 4) Click **OK** to confirm your choice and return to the Print dialog,
- 5) Click the **Print** button to print the document.

Tip Grayscale is best if you have any graphics in the document.

Change the OOO settings to print all color text and graphics as grayscale:

- 1) Choose **Tools > Options > OpenOffice.org > Print**.
- 2) Select the **Convert colors to grayscale** option. Click **OK** to save the change.
- 3) Open the Print dialog (**File > Print**).
- 4) Click the **Print** button to print the document.

Change the OOO Writer (or Calc, Impress, Draw) settings to print all color text as black, and all graphics as grayscale:

- 1) Choose **Tools > Options > OpenOffice.org [Component] > Print**.
- 2) Under *Contents*, select the **Print text in black** option. Click **OK** to save the change.
- 3) Open the Print dialog (**File > Print**).
- 4) Click the **Print** button to print the document.

Previewing pages/sheets before printing

You can use the previewing options in Writer and Calc to view the document as it will be printed. Different viewing options are available.

Writer

The normal page view in Writer shows you what each page will look like when printed and you can edit the pages in that view. If you are designing a document to be printed double-sided, you may want to see what facing pages look like. Writer provides two ways to do this:

- View Layout (editable view): use the Facing Pages (Book Preview) button on the status bar.



- Page Preview (read-only view).





To use Page Preview:

- 1) Choose **File > Page Preview** (or click the **Page Preview** button  on the Standard toolbar).

Writer now displays the **Page Preview** toolbar instead of the Formatting toolbar.



Figure 269. Page Preview toolbar (Writer)

- 2) Select the required preview icon: **Two Pages** () , **Multiple Pages** () or **Book Preview** ().
- 3) To print the document from this view, click the **Print document** icon() to open the Print dialog.
- 4) Choose the print options and click the **Print** button to print.

Calc

To preview the sheets in Calc before printing:

- 1) Choose **File > Page Preview**.

The Calc window now displays the **Page Preview** toolbar instead of the Formatting toolbar.

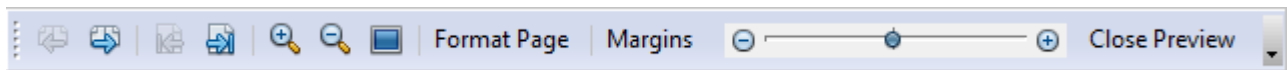



Figure 270. Page Preview toolbar (Calc)

- 2) To print the document from this view, click the **Print document** icon() to open the Print dialog.
- 3) Choose the print options and click the **Print** button.

Exporting to PDF

OpenOffice.org can export documents to PDF (Portable Document Format). This industry-standard file format is ideal for sending the file to someone else to view using Adobe Reader or other PDF viewers.

The process and dialogs are the same for Writer, Calc, Impress, and Draw, with a few minor differences mentioned in this section.

Quick export to PDF

Click the **Export Directly as PDF** icon  to export the entire document using your default PDF settings. You are asked to enter the file name and location for the PDF file, but you do not get a chance to choose a page range, the image compression, or other options.

Controlling PDF content and quality

For more control over the content and quality of the resulting PDF, use **File > Export as PDF**. The PDF Options dialog opens. This dialog has five pages (General, Initial View, User Interface, Links, and Security). Select the appropriate settings, and then click **Export**. Then you are asked to enter the location and file name of the PDF to be created, and click **Save** to export the file.

General page of PDF Options dialog

On the *General* page, you can choose which pages to include in the PDF, the type of compression to use for images (which affects the quality of images in the PDF), and other options.

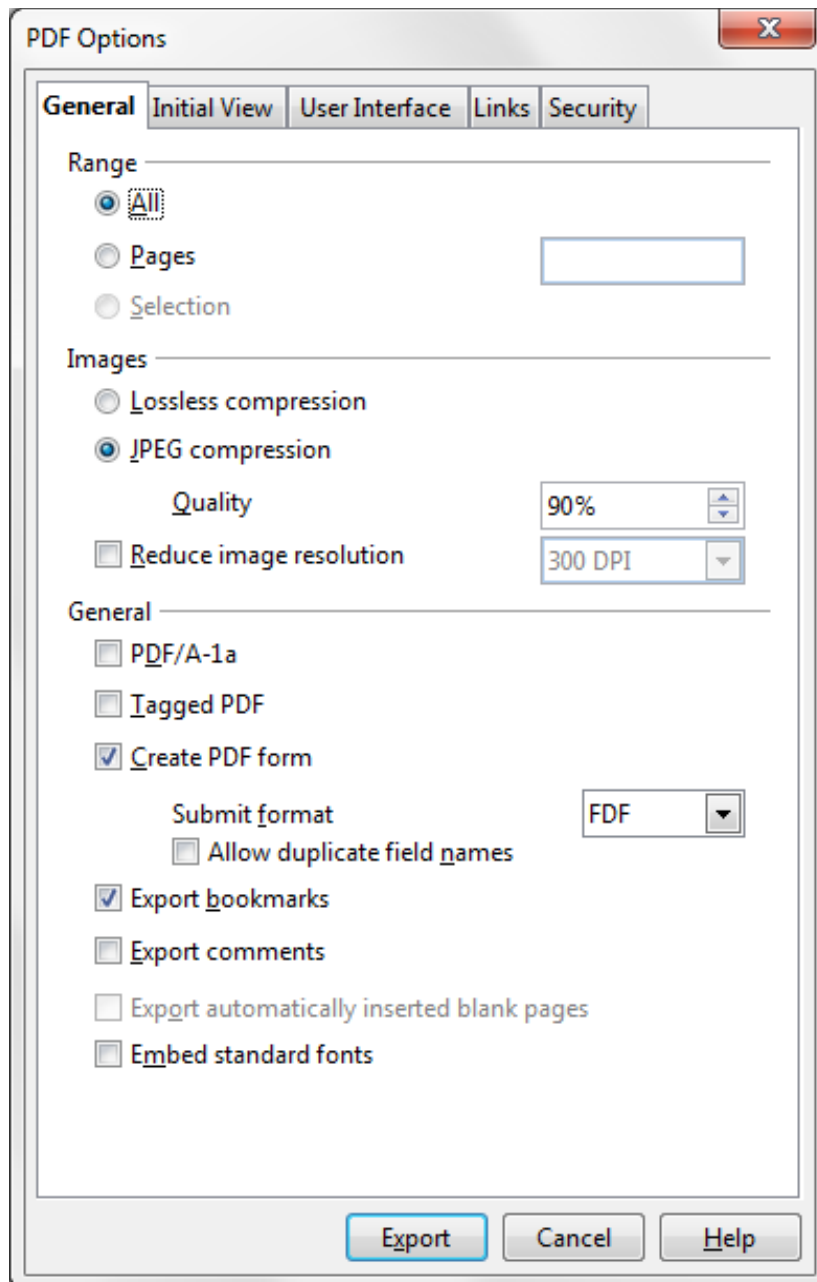

Figure 271: General page of PDF Options dialog

Range section

- **All:** Exports the entire document to PDF.
- **Pages:** To export a range of pages, use the format **3-6** (pages 3 to 6). To export single pages, use the format **7;9;11** (pages 7, 9, and 11). You can also export a combination of page ranges and single pages, by using a format like **3-6;8;10;12**.
- **Selection:** Exports all the selected material.

Images section

- **Lossless compression:** Images are stored without any loss of quality. Tends to make large files when used with photographs. Recommended for other kinds of images or graphics.
- **JPEG compression:** Allows for varying degrees of quality. A setting of 90% works well with photographs (small file size, little perceptible loss of quality).
- **Reduce image resolution:** Lower-DPI (dots per inch) images have lower quality. For viewing on a computer screen generally a resolution of 72dpi (for Windows) or 96dpi (GNU/Linux) is sufficient, while for printing it is generally preferable to use at least 300 or 600 dpi, depending on the capability of the printer. Higher dpi settings greatly increase the size of the exported file.

Note

EPS (Encapsulated PostScript) images with embedded previews are exported only as previews. EPS images without embedded previews are exported as empty placeholders.

General section

- **PDF/A-1a:** PDF/A is an ISO standard for long-term preservation of documents, by embedding all the information necessary for faithful reproduction (such as fonts) while forbidding other elements (including forms, security, and encryption). PDF tags are written. If you select PDF/A-1a, the forbidden elements are greyed-out (not available).
- **Tagged PDF:** Tagged PDF contains information about the structure of the document's contents. This can help to display the document on devices with different screens, and when using screen reader software. Some tags that are exported are table of contents, hyperlinks, and controls. This option can increase file sizes significantly.
- **Create PDF form - Submit format:** Choose the format of submitting forms from within the PDF file. This setting overrides the control's URL property that you set in the document. There is only one common setting valid for the whole PDF document: PDF (sends the whole document), FDF (sends the control contents), HTML, and XML. Most often you will choose the PDF format.
- **Export bookmarks:** Exports headings in Writer documents, and page names in Impress and Draw documents, as "bookmarks" (a table of contents list displayed by some PDF readers, including Adobe Reader).
- **Export comments:** Exports comments in Writer and Calc documents as PDF notes. You may not want this! In Impress, exports a set of Comments pages following the set of slides.
- **Export automatically inserted blank pages:** If selected, automatically inserted blank pages are exported to the PDF. This is best if you are printing the PDF double-sided. For example, books usually have chapters set to always start on an odd-numbered (right-hand) page. When the previous chapter ends

on an odd page, OoO inserts a blank page between the two odd pages. This option controls whether to export that blank page.

- **Embed standard fonts:** In previous versions of OoO, the standard fonts (Times, Helvetica, Courier, Symbol, and ZapfDingbats) were only embedded into the PDF when the resulting file was of the PDF/A type, since the PDF/A standards requires this. In version 3.3, you can choose to embed these fonts in all PDF documents created by OoO to enhance display accuracy in PDF viewers.

Initial View page of PDF Options dialog

On the *Initial View* page, you can choose how the PDF opens by default in a PDF viewer. The selections should be self-explanatory.

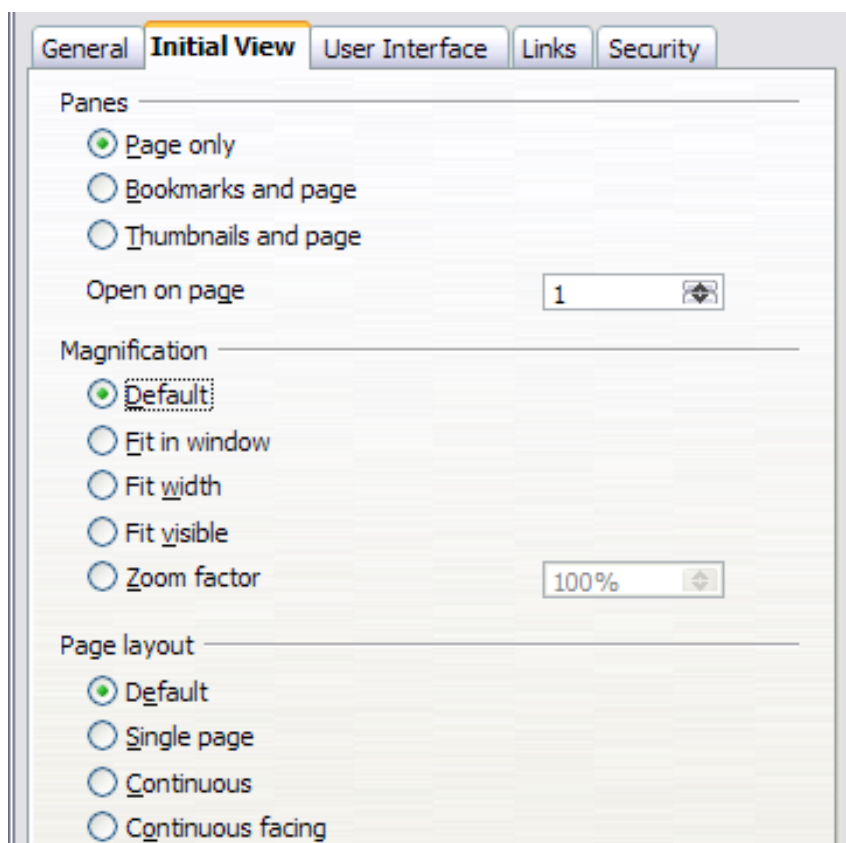

Figure 272: Initial View page of PDF Options dialog

User Interface page of PDF Options dialog

On the *User Interface* page, you can choose more settings to control how a PDF viewer displays the file. Some of these choices are particularly useful when you are creating a PDF to be used as a presentation or a kiosk-type display.

Window options section

- **Resize window to initial page.** Causes the PDF viewer window to resize to fit the first page of the PDF.
- **Center window on screen.** Causes the PDF viewer window to be centered on the computer screen.
- **Open in full screen mode.** Causes the PDF viewer to open full-screen instead of in a smaller window.

- **Display document title.** Causes the PDF viewer to display the document's title in the title bar.

User interface options section

- **Hide menubar.** Causes the PDF viewer to hide the menu bar.
- **Hide toolbar.** Causes the PDF viewer to hide the toolbar.
- **Hide window controls.** Causes the PDF viewer to hide other window controls.

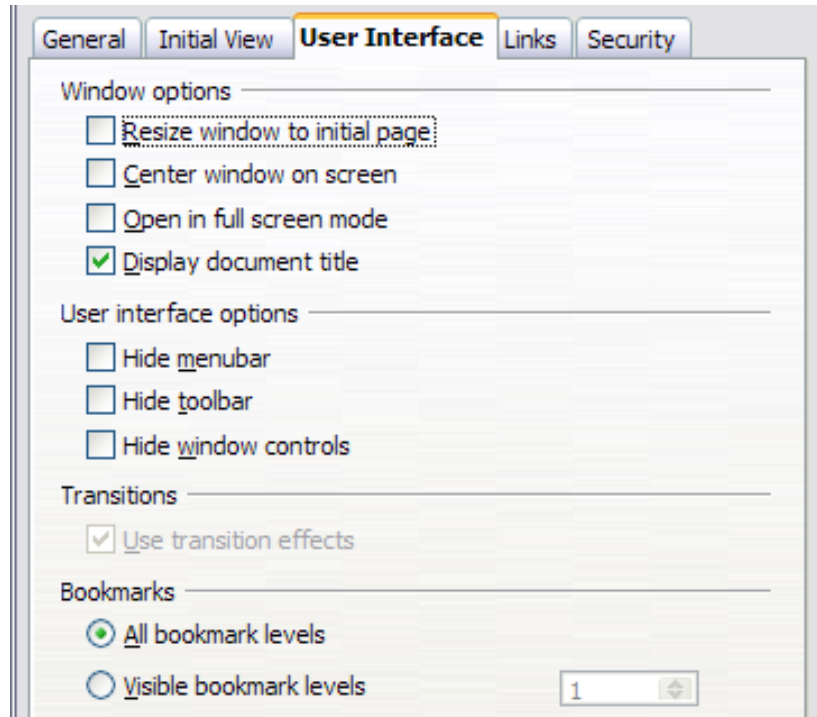

Figure 273: User Interface page of PDF Options dialog

Transitions

In Impress, displays slide transition effects as their respective PDF effects.

Bookmarks

Select how many heading levels are displayed as bookmarks, if *Export bookmarks* is selected on the General page.

Links page of PDF Options dialog

On the *Links* page you can choose how links are exported to PDF.

Export bookmarks as named destinations

If you have defined Writer bookmarks, Impress or Draw slide names, or Calc sheet names, this option exports them as “named destinations” to which Web pages and PDF documents can link.

Convert document references to PDF targets

If you have defined links to other documents with OpenDocument extensions (such as .ODT, .ODS, and .ODP), this option converts the files names to .PDF in the exported PDF document.

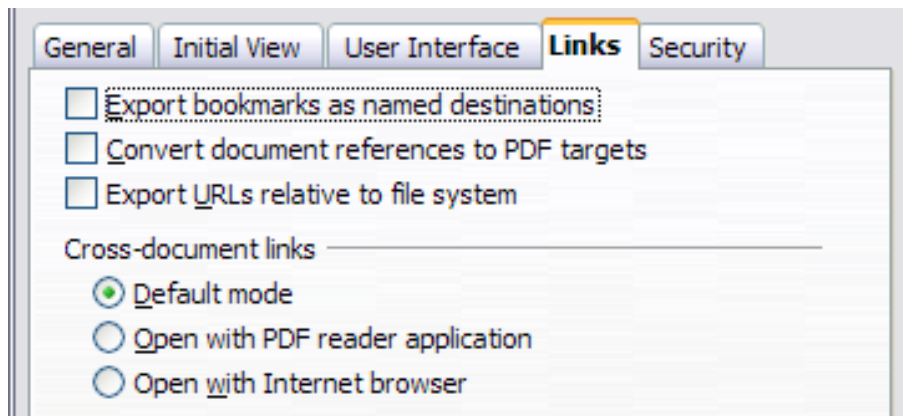

Figure 274: Links page of PDF Options dialog

Export URLs relative to file system

If you have defined relative links in a document, this option exports those links to the PDF.

Cross-document links

Defines the behavior of links clicked in PDF files.

Security page of PDF Options dialog

PDF export includes options to encrypt the PDF (so it cannot be opened without a password) and apply some digital rights management (DRM) features.

- With an *open password* set, the PDF can only be opened with the password. Once opened, there are no restrictions on what the user can do with the document (for example, print, copy, or change it).
- With a *permissions password* set, the PDF can be opened by anyone, but its permissions can be restricted. See Figure 275. After you set a password for permissions, the other choices on the Security page become available.
- With *both* the *open password* and *permission password* set, the PDF can only be opened with the correct password, and its permissions can be restricted.

Note

Permissions settings are effective only if the user's PDF viewer respects the settings.

Figure 276 shows the pop-up dialog displayed when you click the **Set open password** button on the Security page of the PDF Options dialog.

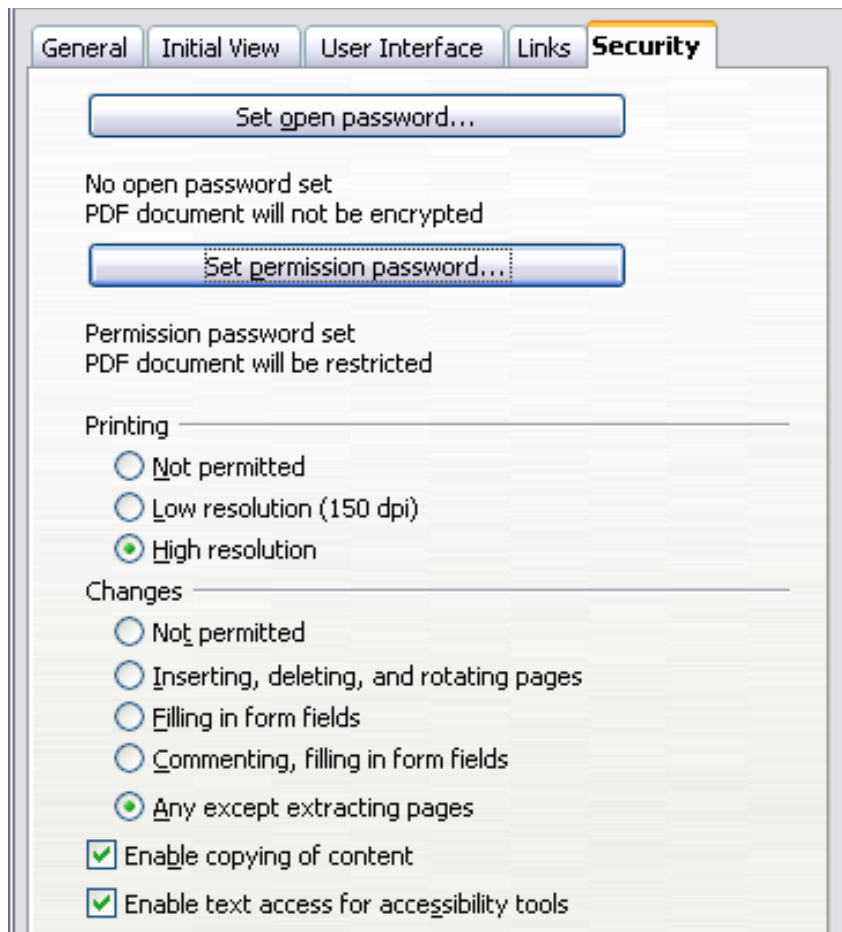

Figure 275: Security page of PDF Options dialog



Figure 276: Setting a password to encrypt a PDF

Exporting to other formats

OOo uses the term “export” for some file operations involving a change of file type. If you cannot find what you want under **File > Save As**, look under **File > Export** as well.

OpenOffice.org can export files to XHTML. In addition, OOo Draw and OOo Impress can export to Adobe Flash (.swf) and a range of image formats.

To export to one of these formats, choose **File > Export**. On the Export dialog, specify a file name for the exported document, then select the required format in the *File format* list and click the **Export** button.

E-mailing documents

OOo provides several ways to quickly and easily send documents as an e-mail attachment in one of three formats: OpenDocument (OOo’s default format), Microsoft Office formats, or PDF.

Note	Documents can only be sent from the OOo menu if a mail profile has been set up.
-------------	---

To send the current document in OpenDocument format:

- 1) Choose **File > Send > Document as E-mail**. OpenOffice.org opens your default e-mail program. The document is attached.
- 2) In your e-mail program, enter the recipient, subject, and any text you want to add, then send the e-mail.

File > Send > E-mail as OpenDocument Text (or Spreadsheet or Presentation) has the same effect.

If you choose **E-mail as Microsoft [Word, Excel, or Powerpoint]**, OOo first creates a file in one of those formats and then opens your e-mail program with the file attached.

Similarly, if you choose **E-mail as PDF**, OOo first creates a PDF using your default PDF settings (as when using the **Export Directly as PDF** toolbar button) and then opens your email program with the .PDF file attached.

E-mailing a document to several recipients

To e-mail a document to several recipients, you can use the features in your e-mail program or you can use OOo’s mail merge facilities to extract email addresses from an address book.

You can use OOo’s mail merge to send e-mail in two ways:

- Use the Mail Merge Wizard to create the document and send it. See Chapter 11 (Using Mail Merge) of the *Writer Guide* for details.
- Create the document in Writer without using the Wizard, then use the Wizard to send it. This method is described here.

To use the Mail Merge Wizard to send a previously-created Writer document:

- 1) Click **Tools > Mail Merge Wizard**. On the first page of the wizard, select **Use the current document** and click **Next**.

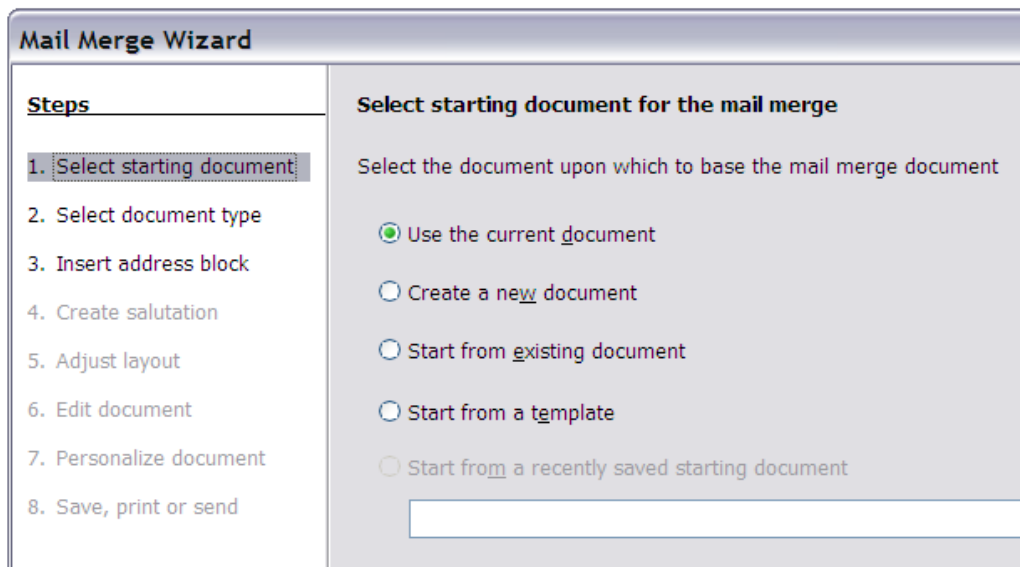

Figure 277: Select starting document

- 2) On the second page, select **E-mail message** and click **Next**.

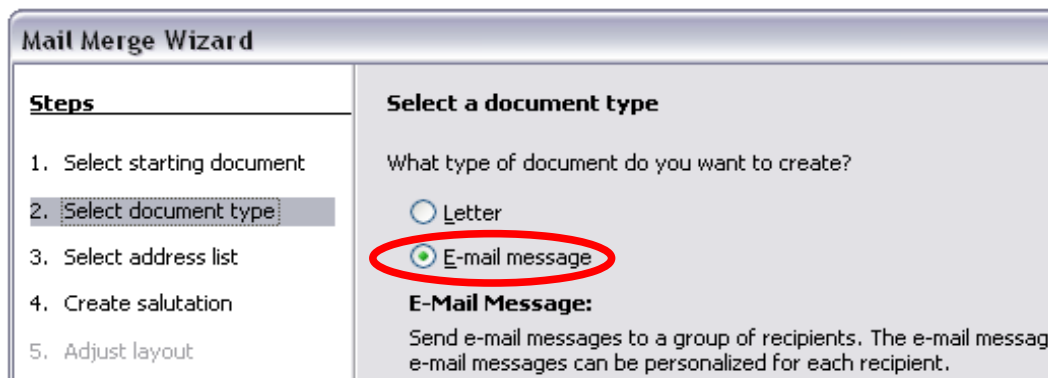

Figure 278: Select document type

- 3) On the third page, click the **Select Address List** button. Select the required address list (even if only one is shown) and then click **OK**. (If the address list you need is not shown here, you can click **Add** to find it and add it to the list.)

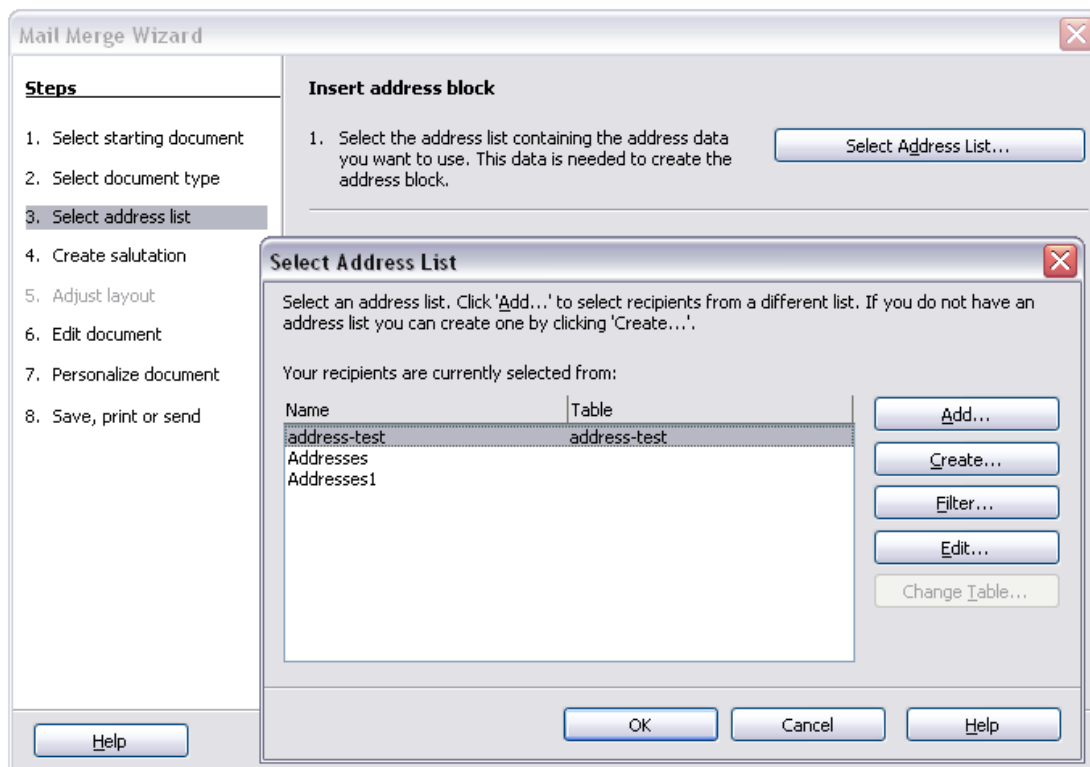

Figure 279: Selecting an address list

- 4) Back on the Select address list page, click **Next**. On the Create salutation page, deselect **This document should contain a salutation**.

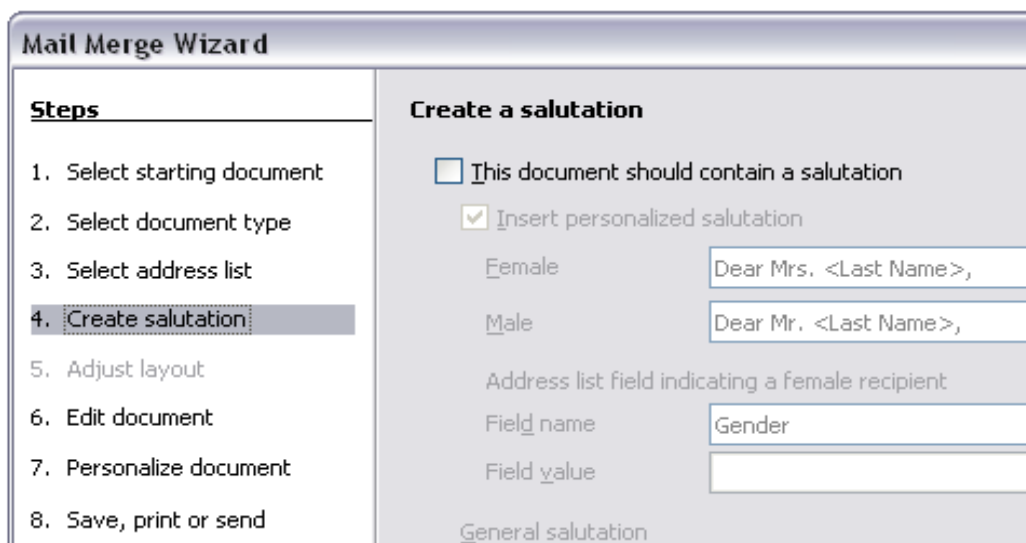

Figure 280: Deselecting a salutation

- 5) In the left-hand list, click **8. Save, print or send**. OOo displays a “Creating documents” message and then displays the *Save, print or send* page of the Wizard.
- 6) Select **Send merged document as E-Mail**. The lower part of the page changes to show e-mail settings choices.

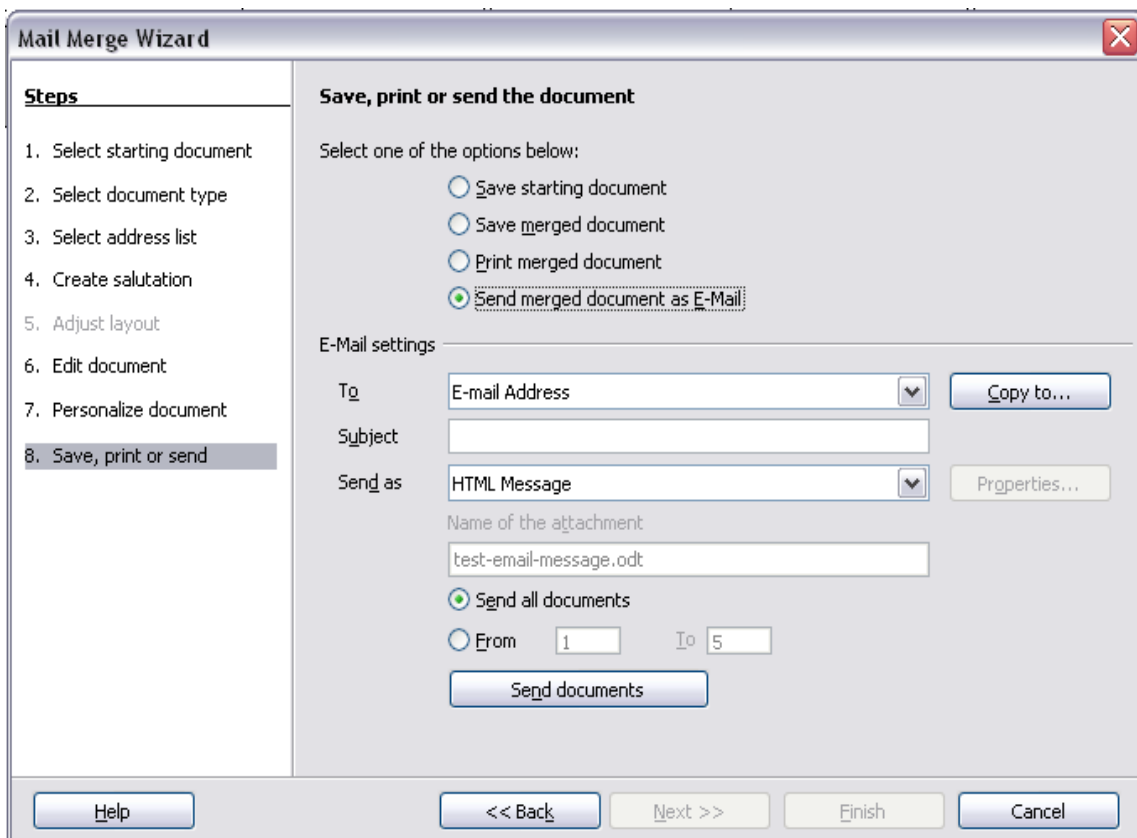

Figure 281: Sending a document as an email message

- 7) Type a subject for your email and click **Send documents**. OOo sends the e-mails.

Digital signing of documents

To sign a document digitally, you need a personal key, also known as a *certificate*. A personal key is stored on your computer as a combination of a private key, which must be kept secret, and a public key, which you add to your documents when you sign them. You can get a certificate from a certification authority, which may be a private company or a governmental institution.

When you apply a digital signature to a document, a kind of checksum is computed from the document's content plus your personal key. The checksum and your public key are stored together with the document.

When someone later opens the document on any computer with a recent version of OpenOffice.org, the program will compute the checksum again and compare it with the stored checksum. If both are the same, the program will signal that you see the original, unchanged document. In addition, the program can show you the public key information from the certificate. You can compare the public key with the public key that is published on the web site of the certificate authority. Whenever someone changes something in the document, this change breaks the digital signature.

On Windows operating systems, the Windows features of validating a signature are used. On Solaris and Linux systems, files that are supplied by Thunderbird, Mozilla or Firefox are used. For a more detailed description of how to get and manage a certificate, and signature validation, see "About Digital Signatures" in the OOo Help.

To sign a document:

- 1) Choose **File > Digital Signatures**.
- 2) If you have not saved the document since the last change, a message box appears. Click **Yes** to save the file.
- 3) After saving, you see the Digital Signatures dialog. Click **Add** to add a public key to the document.
- 4) In the Select Certificate dialog, select your certificate and click **OK**.
- 5) You see again the Digital Signatures dialog, where you can add more certificates if you want. Click **OK** to add the public key to the saved file.

A signed document shows an icon  in the status bar. You can double-click the icon to view the certificate.

Removing personal data

You may wish to ensure that personal data, versions, notes, hidden information, or recorded changes are removed from files before you send them to other people or create PDFs from them.

In **Tools > Options > OpenOffice.org > Security > Options**, you can set OOo to remind (warn) you when files contain certain information and remove personal information automatically on saving.

To remove personal and some other data from a file, go to **File > Properties**. On the *General* tab, uncheck **Apply user data** and then click the **Reset** button. This removes any names in the created and modified fields, deletes the modification and printing dates, and resets the editing time to zero, the creation date to the current date and time, and the version number to 1.

To remove version information, either go to **File > Versions**, select the versions from the list and click **Delete**, or use **Save As** and save the file with a different name.

Chapter 11

Graphics, the Gallery, and Fontwork

Introduction

You can add graphic and image files, including photos, drawings, scanned images, and others, to OpenOffice.org documents. OOO can import various vector (line drawing) and raster (bitmap) file formats. The most commonly used graphic formats are GIF, JPG, PNG, and BMP. See Appendix B for a full list of the graphic formats OOO can import.

Graphics in OOO are of three basic types:

- Image files, such as photos, drawings, and scanned images
- Diagrams created using OOO's drawing tools
- Charts created using OOO's Chart facility

This chapter covers images and diagrams.

More detailed descriptions on working with drawing tools can be found in the *Draw Guide* and *Impress Guide*. Instructions on how to create charts are given in the *Calc Guide*.

Adding images to a document

Images can be added to a document in several ways: by inserting an image file, directly from a graphics program or a scanner, or from the OOO Gallery.

Inserting an image file

When the image is in a file stored on the computer, you can insert it into an OOO document using either of the following methods.

Drag and drop

- 1) Open a file browser window and locate the image you want to insert.
- 2) Drag the image into the Writer document and drop it where you want it to appear. A faint vertical line marks where the image will be dropped.

This method embeds (saves a copy of) the image file in the Writer document. To link the file instead of embedding it, hold down the *Control+Shift* keys while dragging the image.

Insert Picture dialog

- 1) Click in the OOO document where you want the image to appear.
- 2) Choose **Insert > Picture > From File** from the menu bar.
- 3) On the Insert Picture dialog, navigate to the file to be inserted, select it, and click **Open**.

At the bottom of the dialog are two options, **Preview** and **Link**. Choose **Preview** to view a thumbnail of the selected image on the right, so you can verify that you have the correct file. See below for the use of **Link**.

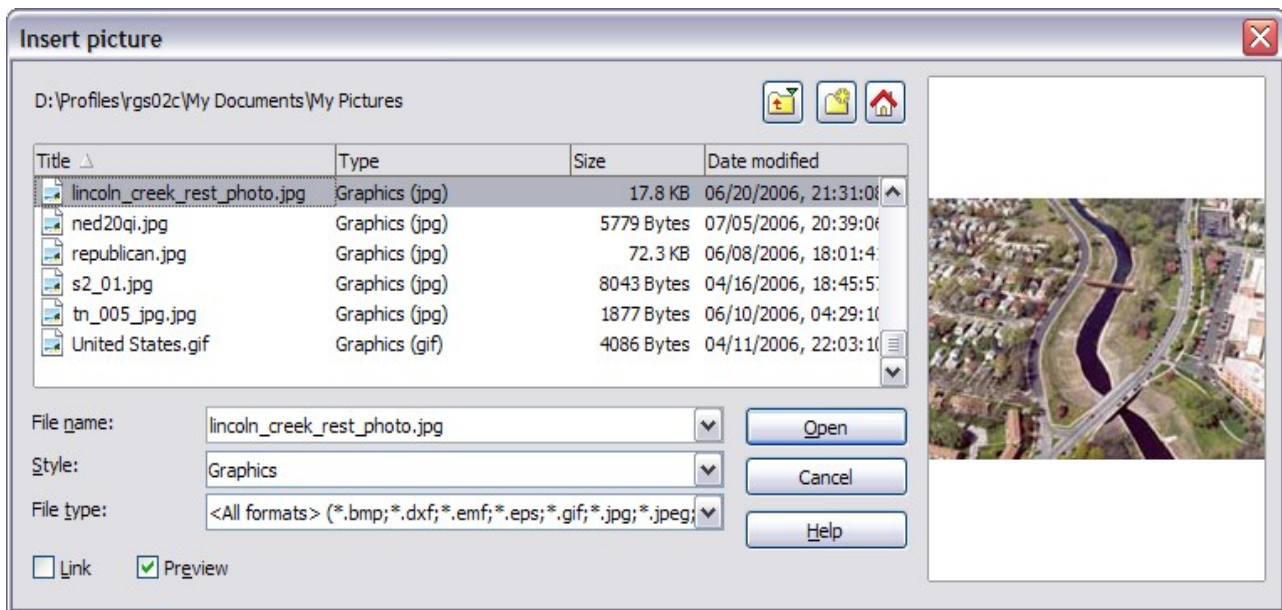

Figure 282. Insert picture dialog

Linking an image file

If the **Link** option in the Insert picture dialog is selected, OOo creates a link to the file containing the image instead of saving a copy of the image in the document. The result is that the image is displayed in the document, but when the document is saved, it contains only a reference to the image file—not the image itself. The document and the image remain as two separate files, and they are merged together only when you open the document again.

Linking an image has two advantages and one disadvantage:

- Advantage - Linking can reduce the size of the document when it is saved, because the image file itself is not included. File size is usually not a problem on a modern computer with a reasonable amount of memory, unless the document includes many large graphics files; OOo can handle quite large files.
- Advantage - You can modify the image file separately without changing the document because the link to the file remains valid, and the modified image will appear when you next open the document. This can be a big advantage if you (or someone else, perhaps a graphic artist) is updating images.
- Disadvantage - If you send the document to someone else, or move it to a different computer, you must also send the image files, or the receiver will not be able to see the linked images. You need to keep track of the location of the images and make sure the recipient knows where to put them on another machine, so the document can find them. For example, you might keep images in a subfolder named Images (under the folder containing the document); the recipient of the file needs to put the images in a subfolder with the same name (under the folder containing the document).

Note

When inserting the same image several times in the document it would appear beneficial to create links; however, this is not necessary as OOo embeds in the document only one copy of the image file.

Embedding linked images

If you originally linked the images, you can easily embed one or more of them later if you wish. To do so:

- 1) Open the document in OpenOffice.org and choose **Edit > Links**.
- 2) The Edit Links dialog (Figure 283) shows all the linked files. In the *Source file* list, select the files you want to change from linked to embedded.
- 3) Click the **Break Link** button.
- 4) Save the document.

Note Going the other way, from embedded to linked, is not so easy—you must delete and reinsert each image, one at a time, selecting the **Link** option when you do so.

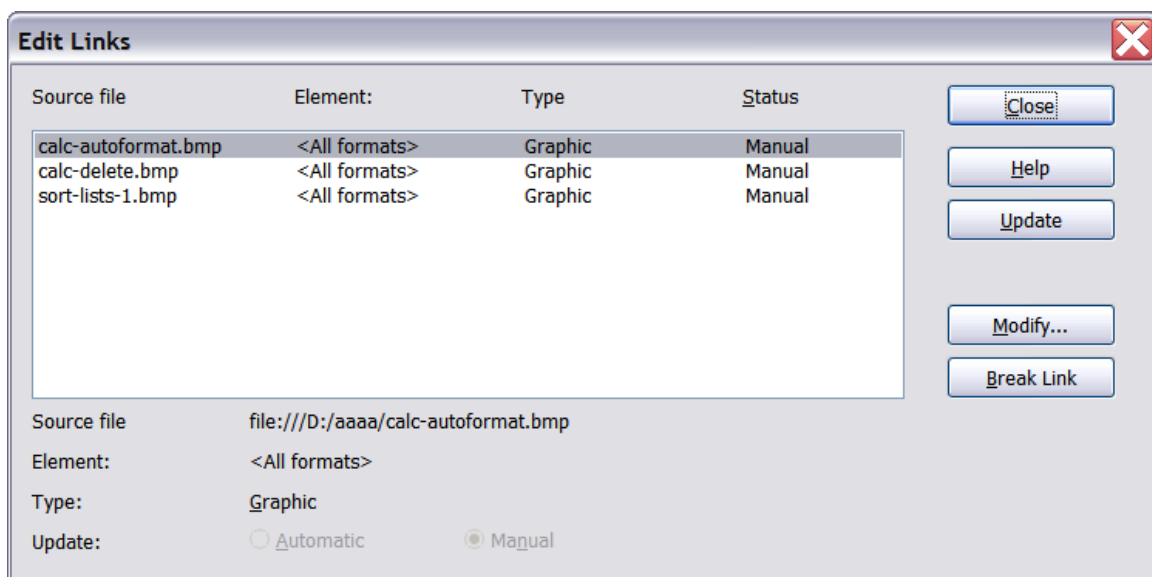

Figure 283: The Edit Links dialog

Inserting an image from the clipboard

Using the clipboard, you can copy images into an OOO document from another OOO document and from other programs. To do this:

- 1) Open both the source document and the target document.
- 2) In the source document, select the image to be copied.
- 3) Move the mouse pointer over the selected image and press *Control+C* to copy the image to the clipboard.
- 4) Switch to the target document.
- 5) Click to place the cursor where the graphic is to be inserted.
- 6) Press *Control+V* to insert the image.

Caution



If the application from which the graphic was copied is closed before the graphic is pasted into the target, the image stored on the clipboard could be lost.

Inserting an image using a scanner

If a scanner is connected to your computer, OOO can call the scanning application and inserted the scanned item into the OOO document as an image. To start this procedure, place the cursor where you want the graphic to be inserted and choose **Insert > Picture > Scan > Select Source**.

Although this practice is quick and easy, it is unlikely to result in a high-quality image of the correct size. You may get better results by scanned material into a graphics program and cleaning it up there before inserting the resulting image into OOO.

Inserting an image from the Gallery

The Gallery provides a convenient way to group reusable objects such as graphics and sounds that you can insert into your documents. The Gallery is available in all components of OOO. See “Managing the OpenOffice.org Gallery” on page 294. You can copy or link an object from the Gallery into a document.

To insert an object:

- 1) Choose **Tools > Gallery** or click the Gallery icon  on the Standard toolbar (in Writer and Calc) or the Drawing toolbar (in Impress and Draw).
- 2) Select a theme.
- 3) Select an object with a single click.
- 4) Drag and drop the image into the document. (See Figure 284.)

You can also right-click on the object and choose **Insert > Copy**.

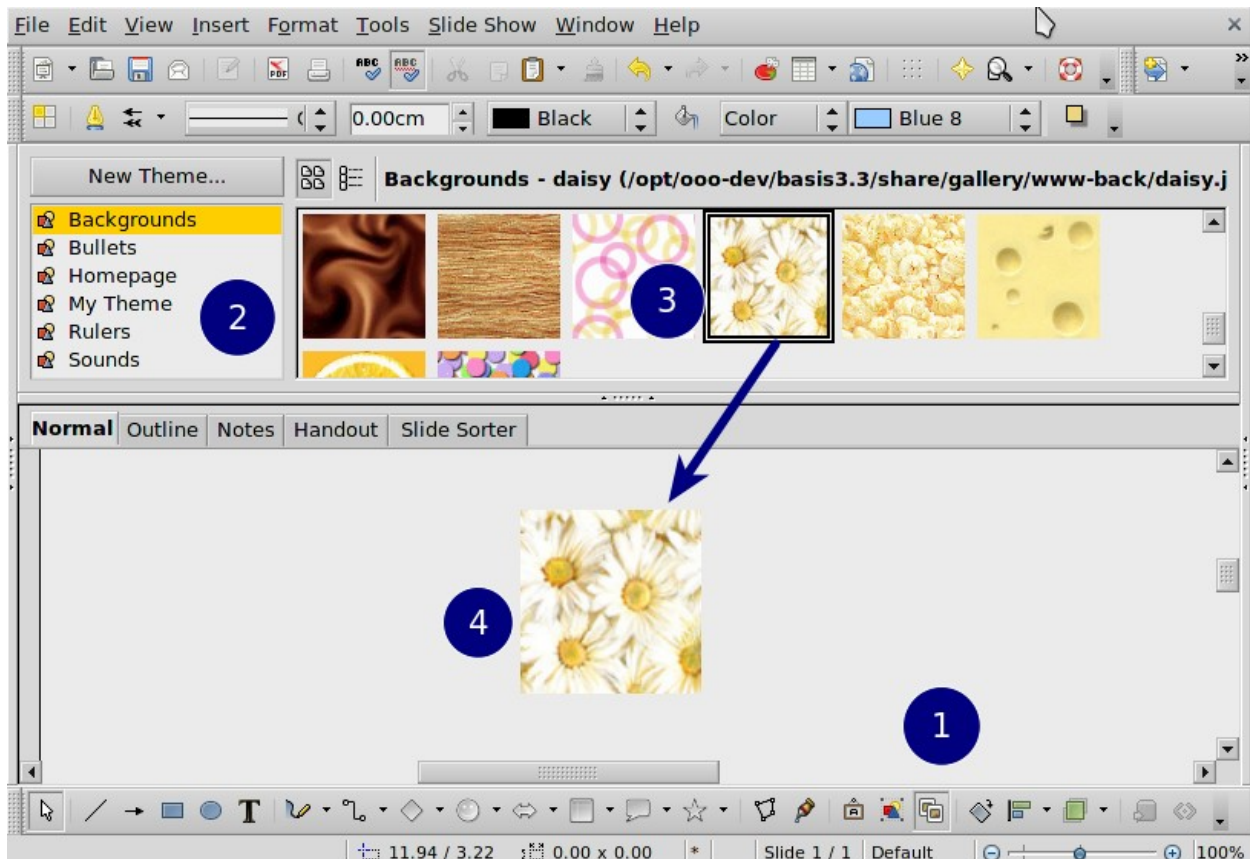

Figure 284: Copying a graphic object from the Gallery into a document

To insert an object as a link:

- 1) Choose **Tools > Gallery** and select a theme.
- 2) Select an object with a single click, then while pressing the *Shift* and *Control* keys, drag and drop the object into the document.

Inserting an image as a background

To insert an image as the background to a page or paragraph:

- 1) Choose **Tools > Gallery** and select a theme.
- 2) Select an object with a single click, right-click on the object, and choose **Insert > Background > Page or > Paragraph**.

Modifying and positioning graphics

OpenOffice.org provides many tools for resizing, modifying, filtering, and positioning graphics; wrapping text around graphics; and using graphics as backgrounds and watermarks. These tools are described in relevant chapters of the other guides. Some sophisticated adjustments of the graphics are best done in an image manipulation program and the results brought into OOO, rather than using OOO's inbuilt tools.

Managing the OpenOffice.org Gallery

Graphics in the Gallery are grouped by themes, such as Bullets, Rulers, and Backgrounds. You can create other groups or themes and add your own pictures or find extensions containing more graphics.

The box on the left of the gallery window lists the available themes. Click on a theme to see its contents displayed in the Gallery window.

You can display the Gallery in *Icon View* (Figure 285) or *Detailed View*, and you can hide or show the Gallery by clicking on the *Hide* button (similar to the Hide button for the Navigator and the Styles and Formatting window when they are docked).

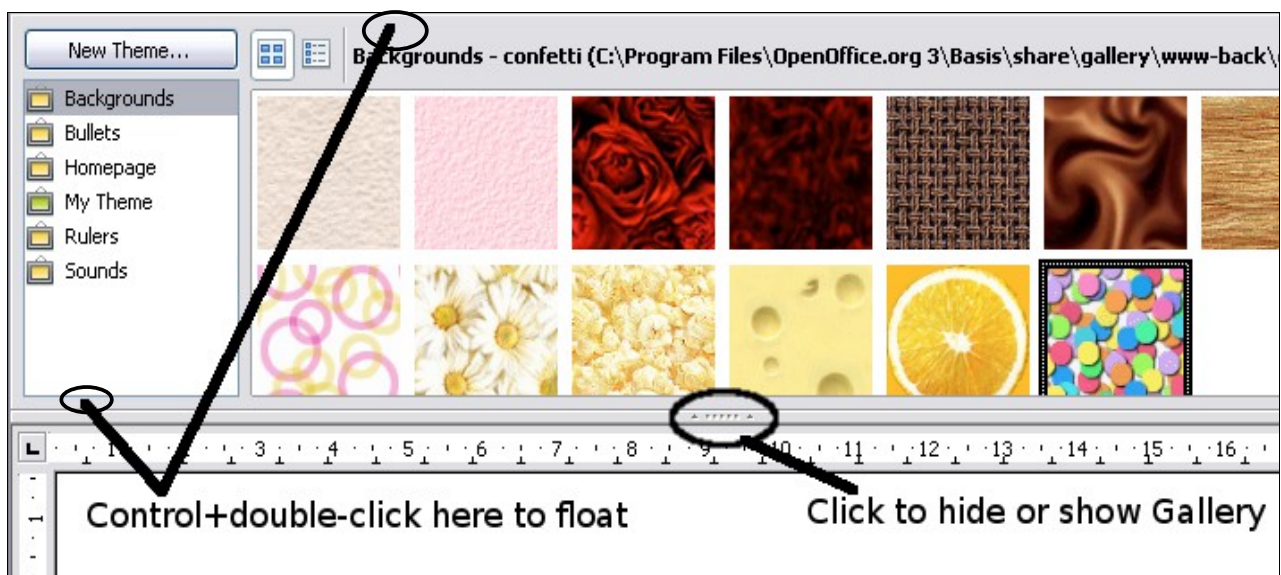

Figure 285: Icon view of one theme in the Gallery

By default, the Gallery is docked above the workspace. To expand the Gallery, position the pointer over the line that divides it from the top of the workspace. When the pointer changes to parallel lines with arrows, click and drag downward. The workspace resizes in response.

As for other docked windows, you can “float” the Gallery by moving the mouse pointer over an edge of the Gallery window, holding down the Control key, and double-clicking. Repeat this procedure to dock the Gallery again.

The default themes are locked; no items can be added to or deleted from these themes. The locked themes are easily recognizable by right-clicking on them; the only available option in the pop-up menu is **Properties**.

In a default installation, only the *My themes* theme is customizable, although new themes can be added as explained in “Adding a new theme to the Gallery” on page 296.

Adding objects to the Gallery

You may wish to add to the Gallery any images that you use frequently, for example, a company logo. You can then very easily insert these graphics into a document later. You can add images only to “My Theme” or to any other theme that you have created; these are indicated by a green icon in the list of themes. You cannot add images to the built-in themes, indicated by an icon of another color.

Method 1 (selecting a file):

- 1) In the theme’s Properties, on the *Files* page, click the **Find Files** button. The Select path dialog opens.
- 2) You can enter the path for the file’s directory in the *Path* text box, or you can navigate to locate the file’s directory. Use the *File type* drop-down list to help limit the search.
- 3) Click the **Select** button to start the search.
- 4) A list of graphic files is then displayed in the window. You can use the *File type* filter again to further limit the search.
- 5) Select the files to add. To select more than one file, hold the *Control* key down while you click on each file.
- 6) Finally, click **Add**.

Method 2 (drag and drop):

- 1) Open the document containing an image you want to add to the Gallery, and display the Gallery theme to which you want to add it.
- 2) Position the mouse pointer above the image, without clicking.
- 3) If the mouse pointer changes to a hand symbol, the image refers to a hyperlink. In this case, press the *Alt* key while you click the image, to select it without activating the link. If the mouse pointer does not change to a hand symbol, you can simply click the image to select it.
- 4) Once the image is selected, evident from the green selection handles around it, release the mouse button. Click again on the image, keeping the mouse button pressed for more than two seconds. Without releasing the mouse button, drag the image into the document.
- 5) Release the mouse button.

Deleting images from the Gallery

To delete an image from a theme that you created:

- 1) Right-click on the name of the image file or its thumbnail in the Gallery.
- 2) Click **Delete** on the pop-up menu. A message appears, asking if you want to delete this object. Click **Yes**.

Note

Deleting the name of a file from the list in the Gallery does not delete the file from the hard disk or other location.

Adding a new theme to the Gallery

To add a new theme to the Gallery:

- 1) Click the **New Theme** button above the list of themes (Figure 285).
- 2) In the Properties of New Theme dialog, click the *General* tab and type a name for the new theme.
- 3) Click the *Files* tab and add images to the theme, as described earlier.

Deleting a theme from the Gallery

You can delete only theme that you have added to the Gallery; you cannot delete any of the inbuilt themes. To delete a theme from the Gallery:

- 1) Go to **Tools > Gallery**.
- 2) In the left part of the Gallery, select in the list the theme you wish to delete.
- 3) Right-click on the theme, then click **Delete** on the pop-up menu.

Location of the Gallery and the objects in it

Graphics and other objects shown in the Gallery can be located anywhere on your computer's hard disk, on a network drive, or on a CD-ROM. Listings in the Gallery refer to the location of each object. When you add graphics to the Gallery, the files are not moved or copied; only the location of each new object is added as a reference.

In a workgroup situation, you may have access to a shared Gallery (where you cannot change the contents unless authorized to do so) and a user Gallery, where you can add, change, or delete objects.

The location of the user Gallery is specified in **Tools > Options > OpenOffice.org > Paths**. You can change this location, and you can copy your gallery files (*.sdv) to other computers.

Gallery contents provided with OOO are stored in a different location. You cannot change this location.

Creating an image map

An image map defines areas of an image (called *hotspots*) with hyperlinks to web addresses, other files on the computer, or parts of the same document. Hotspots are the graphic equivalent of text hyperlinks (described in Chapter 12). Clicking on a hotspot causes OOo to open the linked page in the appropriate program (for example, the default browser for an HTML page; OOo Calc for a .ODS file; a PDF viewer for a PDF file). You can create hotspots of various shapes and include several hotspots in the same image.

To use the image map editor:



- 1) In your OOo document, select the picture where you want to define the hotspots.
- 2) Choose **Edit > ImageMap** from the menu bar. The ImageMap Editor (Figure 286) opens.
- 3) Use the tools and fields in the dialog (described on the next page) to define the hotspots and links necessary.
- 4) Click the **Apply** icon  to apply the settings.
- 5) When done, click the **Save** icon  to save the imagemap to a file, then click the **X** in the upper right corner to close the dialog.



Figure 286: The dialog to create or edit an image map

The main part of the dialog shows the image on which the hotspots are defined. A hotspot is identified by a line indicating its shape.

The toolbar at the top of the dialog contains the following tools:

- **Apply** button: click this button to apply the changes.

- **Load, Save, and Select** icons.
- Tools for drawing a hotspot shape: these tools work in exactly the same way as the corresponding tools in the Drawing toolbar.
- **Edit, Move, Insert, Delete Points**: advanced editing tools to manipulate the shape of a polygon hotspot. Choose the Edit Points tool to activate the other tools.
- **Active** icon: toggles the status of a selected hotspot between active and inactive.
- **Macro**: associates a macro with the hotspot instead of just associating an hyperlink.
- **Properties**: sets the hyperlink properties and adds the Name attribute to the hyperlink.

Below the toolbar, specify for the selected hotspot:

- **Address**: the address pointed by the hyperlink. You can also point to an anchor in a document; to do this, write the address in this format:
file:///<path>/document_name#anchor_name
- **Text**: type the text that you want to be displayed when the mouse pointer is moved over the hotspot.
- **Frame**: where the target of the hyperlink will open: pick among `_blank` (opens in a new browser window), `_self` (opens in the active browser window), `_top` or `_parent`.

Tip

The value `_self` for the target frame will work just fine in the vast majority of occasions. It is therefore not recommended to use the other choices unless absolutely necessary.

Using Oo's drawing tools

You can use Oo's drawing tools to create graphics such as simple diagrams using rectangles, circles, lines, text, and other predefined shapes. You can also group several drawing objects to make sure they maintain their relative position and proportion.

You can place the drawing objects directly on a page in your document, or you can insert them into a frame.

You can also use the drawing tools to annotate photographs, screen captures, or other illustrations produced by other programs, but this is not recommended because:

- You cannot include images in a group with drawing objects, so they may get out of alignment in your document.
- If you convert a document to another format, such as HTML, the drawing objects and the graphics will not remain associated; they are saved separately.

In general, if you need to create complex drawings, it is recommended to use OpenOffice.org Draw, which includes many more features such as layers, styles, and so on.

Creating drawing objects

To begin using the drawing tools, display the Drawing toolbar (Figure 287) by clicking **View > Toolbars > Drawing**.

If you are planning to use the drawing tools repeatedly, you can tear off this toolbar and move it to a convenient place on the window.

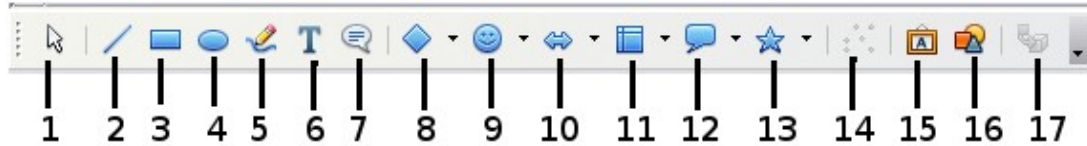

- | | | | |
|-------------|-----------------|-----------------|---------------------|
| 1 Select | 5 Freeform Line | 9 Symbol Shapes | 13 Stars |
| 2 Line | 6 Text | 10 Block arrows | 14 Points |
| 3 Rectangle | 7 Callouts | 11 Flowcharts | 15 Fontwork Gallery |
| 4 Ellipse | 8 Basic Shapes | 12 Callouts | 16 From File |
| | | | 17 Extrusion On/Off |

Figure 287. The Drawing toolbar

To use a drawing tool:

- 1) Click in the document where you want the drawing to be anchored. You can change the anchor later, if necessary.
- 2) Choose the tool from the Drawing toolbar (Figure 287). The mouse pointer changes to a drawing-functions pointer .
- 3) Move the cross-hair pointer to the place in the document where you want the graphic to appear and then click and drag to create the drawing object. Release the mouse button. The selected drawing function remains active, so you can draw another object of the same type.
- 4) To cancel the selected drawing function, press the *Esc* key or click on the **Select** icon (the arrow) on the Drawing toolbar.
- 5) You can now change the properties (fill color, line type and weight, anchoring, and others) of the drawing object using either the Drawing Object Properties toolbar (Figure 288) or the choices and dialogs reached by right-clicking on the drawing object.

Set or change properties for drawing objects

To set the properties for a drawing object before you draw it:

- 1) On the Drawing toolbar (Figure 287), click the **Select** tool.
- 2) On the Drawing Object Properties toolbar (Figure 288), click on the icon for each property and select the value you want for that property.
- 3) For more control, or to define new attributes, you can click on the **Area** or **Line** icons on the toolbar to display detailed dialogs.



- | | | | |
|----------------------|-------------------------------|--------------------------|-------------------------|
| 1 Line | 5 Line Color | 9 To Foreground | 13 Alignment |
| 2 Arrow Style | 6 Area | 10 To Background | 14 Change Anchor |
| 3 Line Style | 7 Area Style / Filling | 11 Bring to Front | 15 Ungroup |
| 4 Line Width | 8 Rotate | 12 Send to Back | 16 Group |

Figure 288. Drawing Object Properties toolbar

The default you set applies to the current document and session. It is not retained when you close the document or close Writer, and it does not apply to any other document you open. The defaults apply to all the drawing objects except text objects.

To change the properties for an existing drawing object:

- 1) Select the object.
- 2) Continue as described above.

You can also specify the position and size, rotation, and slant and corner radius properties of the drawing object:

- 1) Right-click on the drawing object and then choose **Position and Size** from the pop-up menu. The *Position and Size* dialog is displayed.
- 2) Choose any properties, as required.

Resizing a drawing object

The same considerations for resizing an image apply also to resizing an object. Select the object, click on one of the eight handles around it and drag it to its new position. For a scaled resizing, select one of the corner handles and keep the *Shift* key pressed while dragging the handle to its new position.

For more sophisticated control of the size of the object, choose **Format > Object > Position and Size** from the menu bar. Use the Position and Size dialog to set the width and height independently. If the **Keep ratio** option is selected, then the two dimensions change so that the proportion is maintained, allowing for a scaled resizing.

Grouping drawing objects

To group drawing objects:

- 1) Select one object, then hold down the *Shift* key and select the others you want to include in the group. The bounding box expands to include all the selected objects.
- 2) With the objects selected, hover the mouse pointer over one of the objects and choose **Format > Group > Group** from the menu bar or right-click and choose **Group > Group** from the pop-up menu.

Note

You cannot include an embedded or linked graphic in a group with drawing objects.

Using Fontwork

With Fontwork you can create graphical text art objects for making your work more attractive. There are many different settings for text art objects (line, area, position, size, and more), so you have a large choice. You will surely find one that fits your document.

Fontwork is available with each component of OOO, but you will notice small differences in the way that each component displays it.

The Fontwork toolbars

You can use two different toolbars for creating and editing a Fontwork object.

- Go to **View > Toolbars > Fontwork**.

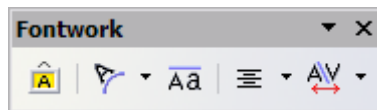

Figure 289: The floating Fontwork toolbar

- If you click on an existing Fontwork object, the Formatting toolbar changes to display the Fontwork options as shown in Figure 294. The contents of this toolbar vary depending on the OOO component with which it is being used.

Creating a Fontwork object

- 1) On the Drawing or Fontwork toolbar, click the Fontwork Gallery icon . If the Drawing toolbar is not visible, go to **View > Toolbars > Drawing** to display it.
- 2) In the Fontwork Gallery (Figure 290), select a Fontwork style, then click **OK**. The Fontwork object will appear in your document. Notice the blue squares around the edge (indicating that the object is selected) and the yellow dot; these are discussed in “Moving and resizing Fontwork objects” on page 306.



Figure 290: The Fontwork Gallery

- 3) Double-click the object to edit the Fontwork text. Type your own text in place of the black *Fontwork* text that appears over the object (Figure 291).



Figure 291: Editing Fontwork text

- 4) Click anywhere in a free space or press *Esc* to apply your changes.

Editing a Fontwork object

Now that the Fontwork object is created, you can edit some of its attributes. To do this, you can use the Fontwork toolbar, the Formatting toolbar, or menu options as described in this section. If the selected Fontwork object is a 3D object, you can also use the 3D-Settings toolbar.

Using the Fontwork toolbar

Make sure that the Fontwork toolbar, shown in Figure 289, is visible. If you do not see it, go to **View > Toolbars > Fontwork**. Click on the different icons to edit Fontwork objects.



Fontwork Shape: Edits the shape of the selected object. You can choose from a palette of shapes.

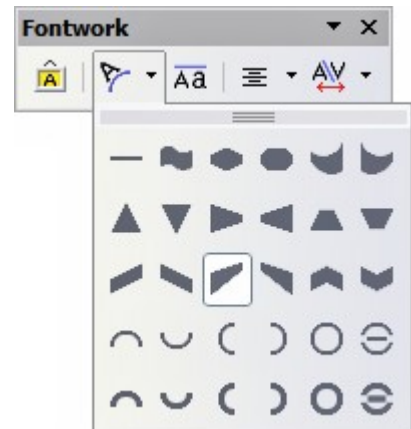

Figure 292: Fontwork toolbar showing palette of shapes



Fontwork Same Letter Heights: Changes the height of characters in the object. Toggles between normal height (some characters taller than others, for example capital letters, d, h, l and others) and all letters the same height.



Figure 293: Left: normal letters; right: same letter heights



Fontwork Alignment: Changes the alignment of characters. Choices are left align, center, right align, word justify, and stretch justify. The effects of the text alignment can only be seen if the text spans over two or more lines. In the stretch justify mode, all the lines are filled completely.

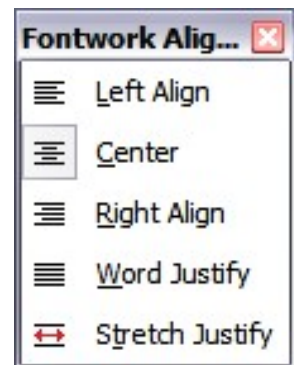



Fontwork Character Spacing: Changes the character spacing and kerning in the object. For custom spacing, input a percentage value: 100% is normal spacing; less than 100% is tight spacing; more than 100% is expanded spacing.

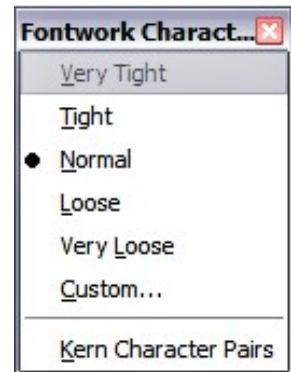

Using the Formatting toolbar

Now let us go further and customize the Fontwork object with several more attributes.

Click on the Fontwork object. The Formatting toolbar changes to show the options for editing the object. (The toolbar shown in Figure 294 appears when you use Fontwork in Writer.)

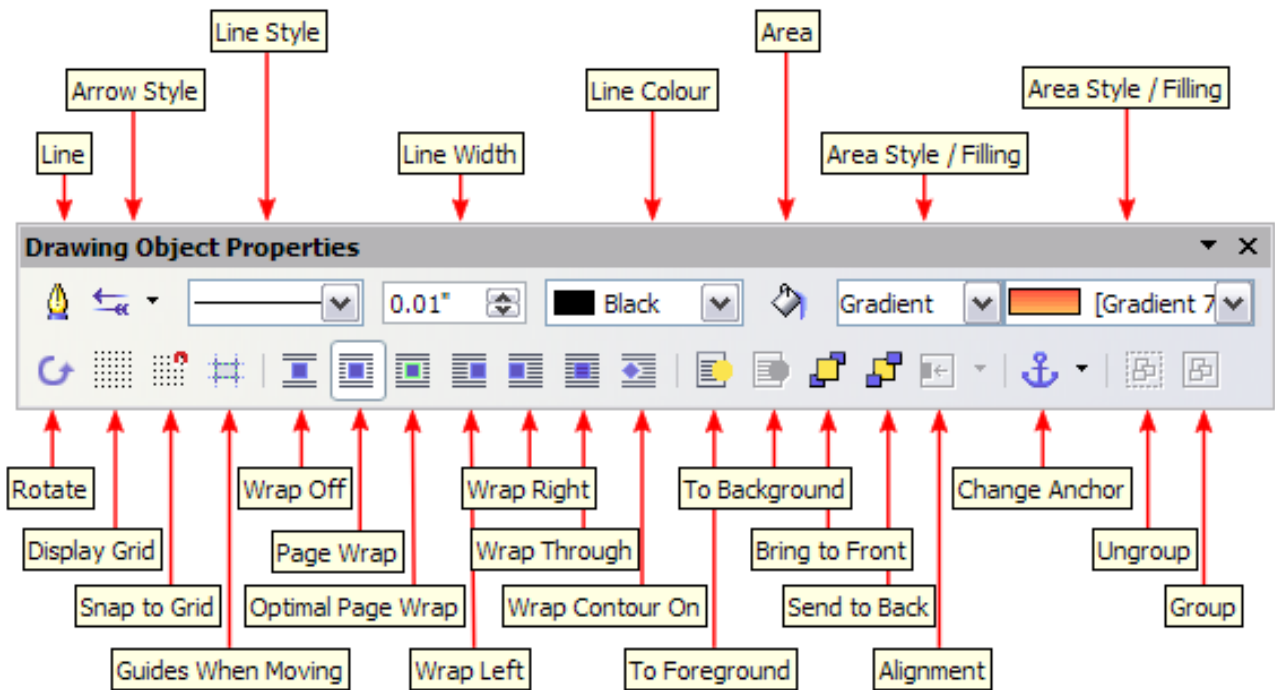

Figure 294: Formatting toolbar for a Fontwork object in Writer

This figure shows the toolbar floating. In its default, docked position it is one of the toolbars located below the menu bar. The example toolbar has also been customized to show all of the available options; by default only a subset of these options is shown.

On the Formatting toolbar you have a large choice of options for customizing your object. These choices are the same as the ones for other drawing objects. For more information, see the *Draw Guide*.

Line options

Line icon: Opens a dialog with three tabs: **Line**, **Line Styles**, **Arrow Styles**. Use the **Line** tab to edit the most common properties of the line around the selected Fontwork object, by choosing from previously-defined attributes including line style, line color, and arrow styles. Use the **Lines Styles** and **Arrow Styles** tabs to edit the properties of line and arrow styles, and define new styles.

Arrow Style icon: Choose from the different arrow styles.

Line Style box: Choose from the available line styles.

Line Width box: Set the width of the line.

Line Color box: Select the color of the line.

Area options

Area icon: Opens a dialog with seven tabs: **Area**, **Shadow**, **Transparency**, **Colors**, **Gradients**, **Hatching**, **Bitmaps**.

- **Area** tab: Choose from the predefined list a color, bitmap, gradient or hatching pattern to fill the selected object.
- **Shadow** tab: Set the shadow properties of the selected object.
- **Transparency** tab: Set the transparency properties of the selected object.
- **Colors** tab: Modify the available colors or add new ones to appear on the Area tab.
- **Gradients** tab: Modify the available gradients or add new ones to appear on the Area tab.
- **Hatching** tab: Modify the available hatching patterns or add new ones to appear on the Area tab.
- **Bitmaps** tab: Create simple bitmap patterns and import bitmaps, to make them available on the Area tab.

Area Style / Filling boxes: Select the type of the fill of the selected object. For more detailed settings, use the Area icon.

Positioning options

Rotate icon: Rotate the selected object manually using the mouse to drag the object.

To Foreground icon: Move the selected object in front of the text.

To Background icon: Move the selected object behind the text.

Alignment icon: Modify the alignment of the selected objects.

Bring to front icon: Move the selected object in front of the others.

Send to back icon: Move the selected object behind the others.

Change Anchor icon: Choose between anchoring options:

- To Page - The object keeps the same position in relation to the page margins. It does not move as you add or delete text.
- To Paragraph - The object is associated with a paragraph and moves with the paragraph. It may be placed in the margin or another location.
- To Character - The object is associated with a character but is not in the text sequence. It moves with the paragraph but may be placed in the margin or another location. This method is similar to anchoring to a paragraph.

- As Character - The object is placed in the document like any character and moves with the paragraph as you add or delete text before the object.

Ungroup icon: Ungroup the selected objects, so you can manage them individually.

Group icon: Group the selected objects, so you can manage them as a single object.

Using menu options

You can use some the choices on the **Format** menu to anchor, align, arrange and group selected Fontwork objects, wrap text around them, and flip them horizontally and vertically.

You can also right-click on a Fontwork object and choose many of the same options from the pop-up menu. The pop-up menu also provides quick access to the Line, Area, Text, and Position and Size dialogs. The Text dialog offers only a few options for Fontwork objects and is not discussed here. On the Position and Size dialog, you can enter precise values concerning size and position. For more information on all of these menu options, see the *Draw Guide*.

Using the 3D-Settings toolbar

If the selected Fontwork object is a 3D object, you can also use the options on the 3D-Settings toolbar. You can also change a 2D Fontwork object into a 3D object (or change a 3D object into a 2D object) by clicking the Extrusion On/Off icon on the 3D-Settings toolbar. For more information, see the *Draw Guide*.

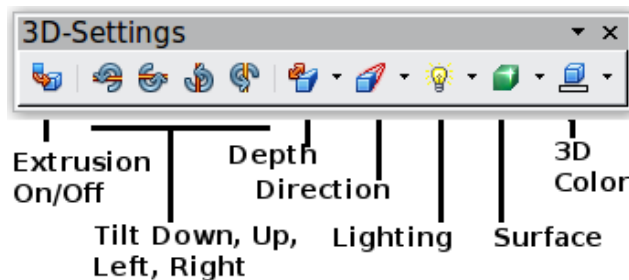

Figure 295: 3D-Settings toolbar

Moving and resizing Fontwork objects

When you select a Fontwork object, eight blue squares (known as *handles*) appear around the edge of the object, as shown below. You can drag these handles to resize the object.

A yellow dot also appears on the object. This dot may be along an edge of the object, or it may be somewhere else; see figure to right for an example. If you hover the pointer over this yellow dot, the pointer turns into a hand symbol. You can drag the dot in different directions to distort the object.

Hovering the pointer over other parts of the object turns the pointer into the usual symbol for dragging the object to another part of the page.



For precise control of the location and size of the object, use the Position and Size dialog.

Chapter 12

Creating Web Pages

Saving Documents as HTML Files

Introduction

This chapter describes how to do the following in Writer, Calc, Draw and Impress:

- Create hyperlinks within a document and to other documents such as web pages, PDFs, and other files.
- Save documents as web pages (HTML documents).

When creating a document that you plan to deliver as a web page, you need to consider the following:

- In an HTML document, hyperlinks are active (clickable) but other cross-references inserted by OOO are not active links.
- An object such as a image is saved as a separate file. However, if that object has been placed in a frame (for example, with an associated caption), it is not saved and does not appear in the HTML document; instead, the name of the frame appears.

Relative and absolute hyperlinks

Hyperlinks stored within a file can be either relative or absolute.

A relative hyperlink says, *Here is how to get there starting from where you are now* (meaning from the folder in which your current document is saved) while an absolute hyperlink says, *Here is how to get there no matter where you start from*.

An absolute link will stop working if the target is moved. A relative link will stop working if the start and target locations change relative to each other. For instance, if you have two spreadsheets in the same folder linked to each other and you move the entire folder to a new location, an absolute hyperlink will break but a relative one will not.

To change the way that OOO stores the hyperlinks in your file, select **Tools > Options > Load/Save > General** and choose if you want URLs saved relatively when referencing the *File System*, or the *Internet*, or both.

Calc will always display an absolute hyperlink. Don't be alarmed when it does this even when you have saved a relative hyperlink—this 'absolute' target address will be updated if you move the file.

Note

Make sure that the folder structure on your computer is the same as the file structure on your web server if you save your links as relative to the file system and you are going to upload pages to the Internet.

Tip

When you rest the mouse pointer on a hyperlink, a help tip displays the absolute reference, since OOO uses absolute path names internally. The complete path and address can only be seen when you view the result of the HTML export (saving the spreadsheet as an HTML file), by loading the HTML file as Text, or by opening it with a text editor.

Creating hyperlinks

When you type text (such as a website addresses or URL) that can be used as a hyperlink, and then press the spacebar or the *Enter* key, OOO automatically creates the hyperlink and applies formatting to the text (usually a color and underlining). If this does not happen, you can enable this feature using **Tools > AutoCorrect Options > Options** and selecting the **URL Recognition** option.

If you do not want OOO to convert a specific URL to a hyperlink, choose **Edit > Undo Insert** from the menu bar or press *Control+Z* immediately after the formatting has been applied.

Tip

To change the color of hyperlinks, go to **Tools > Options > OpenOffice.org > Appearance**, scroll to *Unvisited links* and/or *Visited links*, pick the new colors and click **OK**. Caution: this will change the color for all hyperlinks in all components of OpenOffice.org; this may not be what you want.

In Writer and Calc (but not Draw or Impress), you can also change the Internet link character style or define and apply new styles to selected links.

You can also insert hyperlinks using the Navigator and the Hyperlink dialog, and you can modify all hyperlinks using the Hyperlink dialog as described in this section.

Using the Navigator

The easiest way to insert a hyperlink to another part of the same document is by using the Navigator:

- 1) Open the documents containing the items you want to cross-reference.
- 2) Open the Navigator by clicking its icon , by choosing **View > Navigator**, or by pressing *F5*.
- 3) Click the arrow next to the **Drag Mode** icon, and choose **Insert as Hyperlink**. (See Figure 296.)
- 4) In the list at the bottom of the Navigator, select the document containing the item that you want to cross-reference.
- 5) In the Navigator list, select the item that you want to insert as a hyperlink.
- 6) Drag the item to where you want to insert the hyperlink in the document. The name of the item is inserted in the document as an active hyperlink.

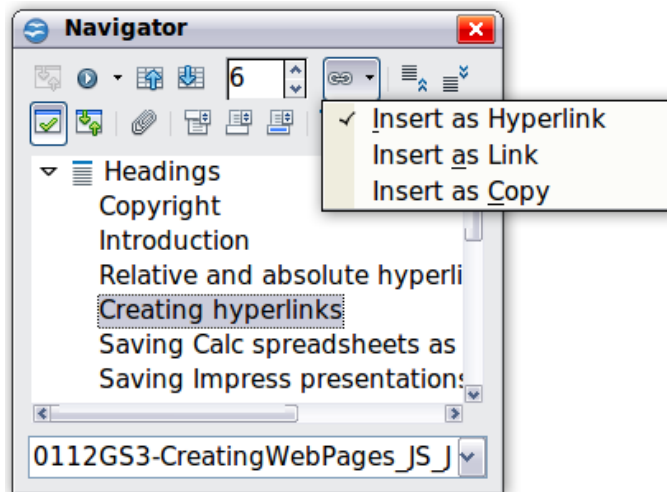



Figure 296: Inserting a hyperlink using the Navigator

When using the Navigator to hyperlink to an object such as a graphic, to have the hyperlink show useful text such as *2009 Sales Graph*, you need to give such objects useful names instead of leaving them as the default names (“Graphics6”), or you need to edit the resulting link text using the Hyperlink dialog, as described below.

You can also use the Navigator to insert a hyperlink from one document (the source) to a specific place in another document (the target). Open the Navigator in the target document and drag the item to the spot in the source document where you want the hyperlink to appear.

Using the Hyperlink dialog

To display the dialog, click the **Hyperlink** icon  on the Standard toolbar or choose **Insert > Hyperlink** from the menu bar. To turn existing text into a link, highlight it before opening the dialog.

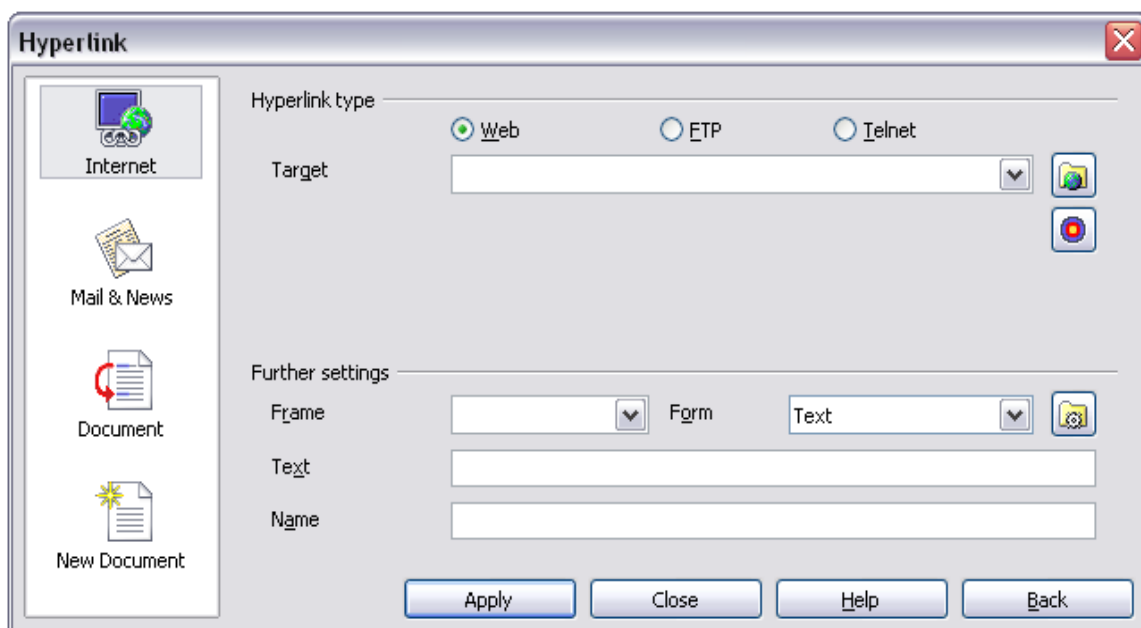

Figure 297: Hyperlink dialog showing details for Internet links

On the left side, select one of the four categories of hyperlink:

- **Internet:** the hyperlink points to a web address, normally starting with `http://`
- **Mail & News:** the hyperlink opens an email message that is pre-addressed to a particular recipient
- **Document:** the hyperlink points to another document or to another place in the current document
- **New document:** the hyperlink creates a new document

The top right part of the dialog changes according to the choice made for the hyperlink category in the left panel. A full description of all the choices and their interactions is beyond the scope of this chapter. Here is a summary of the most common choices.

For an *Internet* hyperlink, choose the type of hyperlink (Web, FTP, or Telnet), and enter the required web address (URL).

For a *Mail and News* hyperlink, specify whether it is a mail or news link, the receiver's address, and for email, also the subject.

For a *Document* hyperlink, specify the document path (the **Open File** button opens a file browser) or leave this blank if you want to link to a target in the same document. Optionally specify the target in the document (for example a specific slide). Click on the **Target in Document** icon to open the Navigator where you can select the target; or if you know the name of the target, you can type it into the box.

For a *New Document* hyperlink, specify whether to edit the newly created document immediately (**Edit now**) or just create it (**Edit later**), enter the file name, and select the type of document to create (text, spreadsheet, and so on). Click the **Select Path** button to open a file browser and choose where to store the file.

The *Further settings* section in the bottom right part of the dialog is common to all the hyperlink categories, although some choices are more relevant to some types of links.

- Set the value of **Frame** to determine how the hyperlink will open. This applies to documents that open in a Web browser.
- **Form** specifies if the link is to be presented as text or as a button. Figure 298 shows a link formatted as a button. A hyperlink button is a type of form control. See Chapter 15 of the *Writer Guide* for more information.

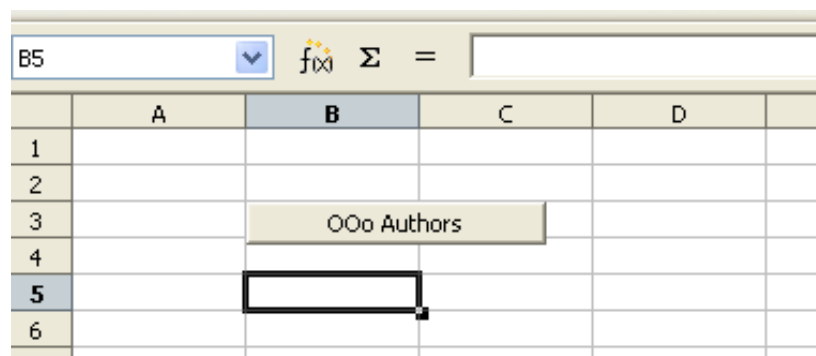



Figure 298: OOo Authors hyperlink as button

- **Text** specifies the text that will be visible to the user. If you do not enter anything here, OOo uses the full URL or path as the link text. Note that if the link is relative and you move the file, this text will not change, though the target will.

- **Name** is applicable to HTML documents. It specifies text that will be added as a NAME attribute in the HTML code behind the hyperlink.
- **Events** button : click this button to open the Assign Macro dialog and choose a macro to run when the link is clicked. See Chapter 13 (Getting Started with Macros) for more information.

Editing hyperlinks

To edit an existing link, click anywhere in the link text and then click the **Hyperlink**

icon  on the Standard toolbar or choose **Edit > Hyperlink** from the menu bar. The Hyperlink dialog opens. Make your changes and click **Apply**. If you need to edit several hyperlinks, you can leave the Hyperlink dialog open until you have edited all of them. Be sure to click **Apply** after each one. When you are finished, click **Close**.

The standard (default) behavior for activating hyperlinks within OOo is to use *Ctrl+click*. This behavior can be changed in **Tools > Options > OpenOffice.org > Security > Options**, by deselecting the option **Ctrl-click required to follow hyperlinks**. If clicking in your links activates them, check that page to see if the option has been deselected.

Removing hyperlinks

You can remove the clickable link from hyperlink text—leaving just the text—by right-clicking on the link and selecting **Default Formatting**. This option is also available from the **Format** menu. You may then need to re-apply some formatting in order for the text to match the rest of your document.

To erase the link text or button from the document completely, select it and press the *Backspace* or *Delete* key.

Saving Writer documents as web pages

Writer's HTML capabilities include saving existing documents in HTML format, creating new documents as HTML (not described here), and creating several different types of web pages using a wizard.

The easiest way to create HTML documents is to start with an existing Writer document. You can get a good idea of how it will appear as a web page by using **View > Web Layout**. However, web layout view will not show you which features will or won't save correctly to HTML. Some considerations are described in the introduction to this chapter.

Saving a document as a single web page

To save a document as a single web page (HTML format), choose **File > Save As** and specify **HTML Document** as the file type.

Note

Writer does not replace multiple spaces in the original document with the HTML code for non-breaking spaces. If you want to have extra spaces in your HTML file or web page, you need to insert non-breaking spaces in OOo. To do this, press *Control+Spacebar* instead of just *Spacebar*.

Saving a document as a series of web pages

Writer can save a large document as a series of web pages (HTML files) with a table of contents page. To do this:

- 1) Decide which headings in the document should start on a new page and make sure all those headings have the same style (for example, Heading 1).
- 2) Choose **File > Send > Create HTML Document**.
- 3) In the Name and Path dialog, type the file name to save the pages under. Also specify which style indicates a new page (as decided in step 1).
- 4) Click **Save** to create the multi-page HTML document. (For those who may be interested, the resulting HTML files conform to the HTML 4 Transitional.)

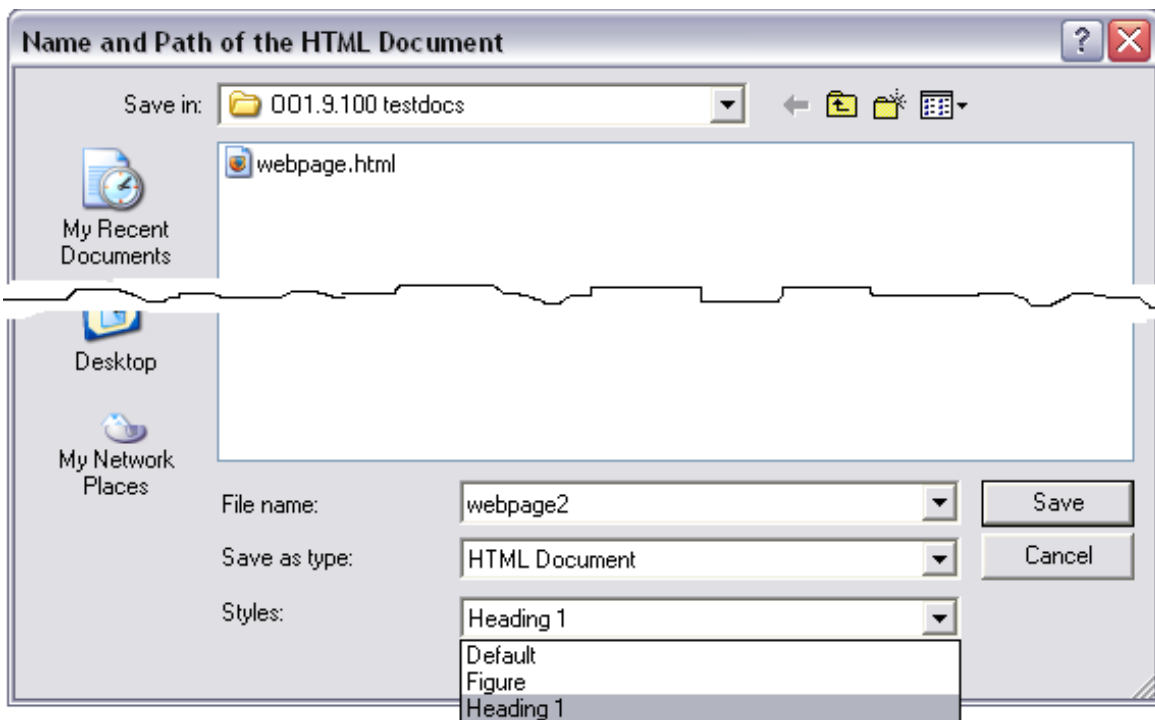

Figure 299. Creating a series of web pages from one document

Creating web pages using a Wizard

Oo's Web wizard allows you to create several types of standard web pages. To use it:

- 1) Choose **File > Wizards > Web Page**. On the first page of the Wizard, choose settings and click **Next**. If this is your first web page, the only choice is <default>.



- 2) Choose or browse to the document you would like to format. The *Title*, *Summary* and *Author* information is picked up from the document's properties; if necessary, edit it. Click **Next**.

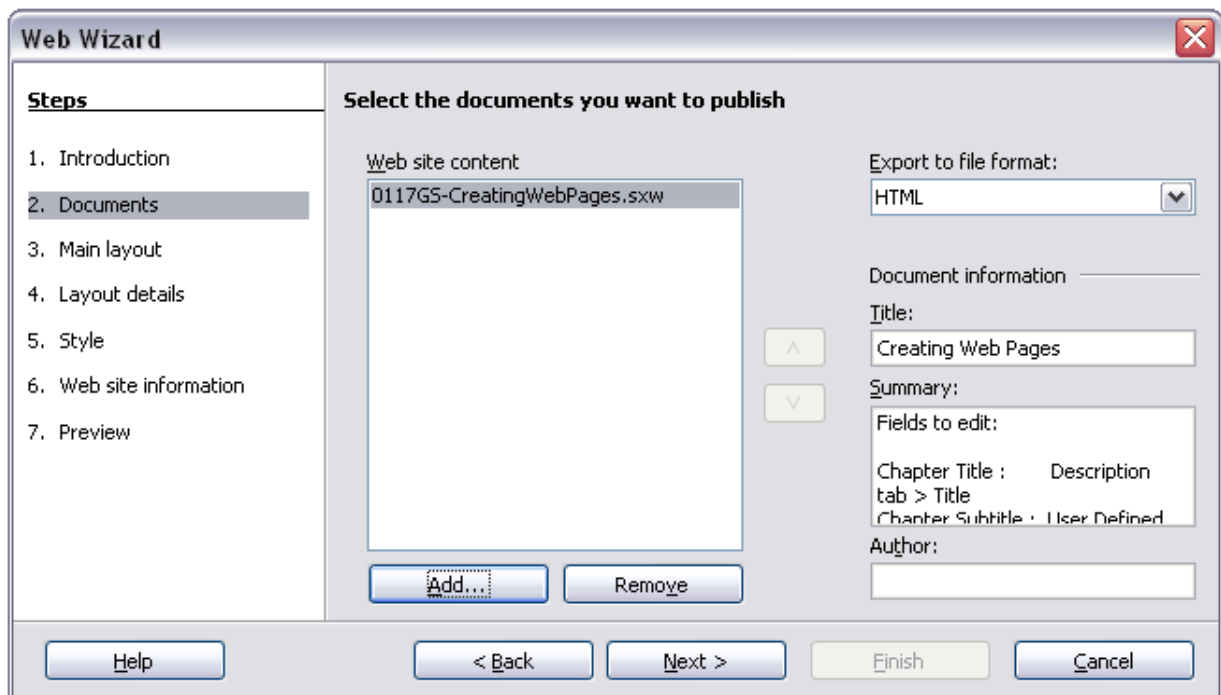

3) Chose a layout for the web site by clicking on the layout boxes. Click **Next**.

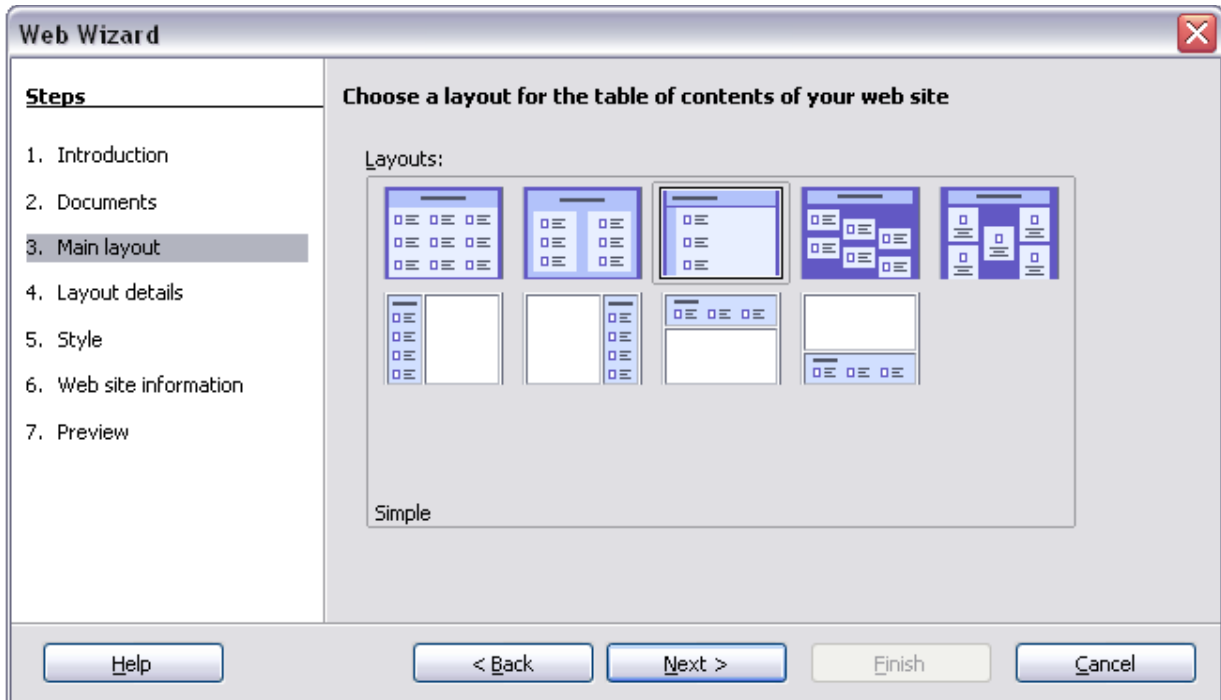

4) Chose the information to be listed and the screen resolution. Click **Next**.

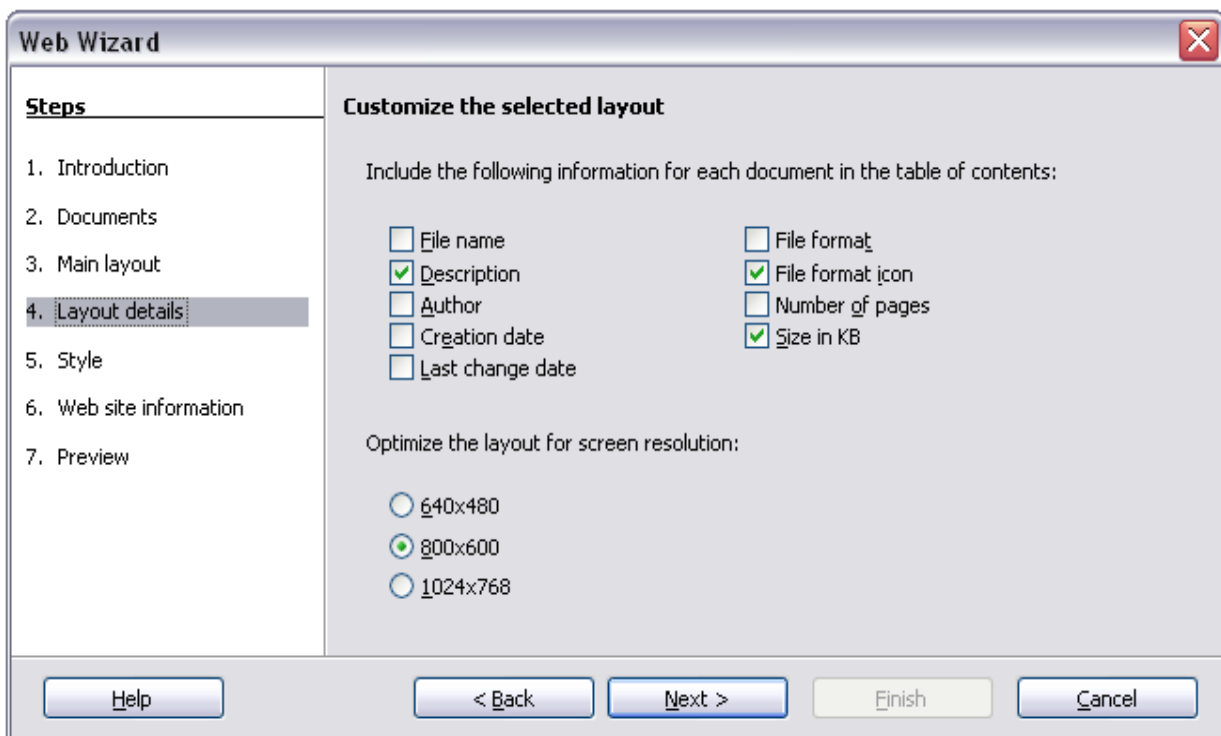

- 5) Select a style for the page. Use the drop-down list to choose different styles and color combinations. You can browse to a background image and icon set from the Gallery. Click **Next**.

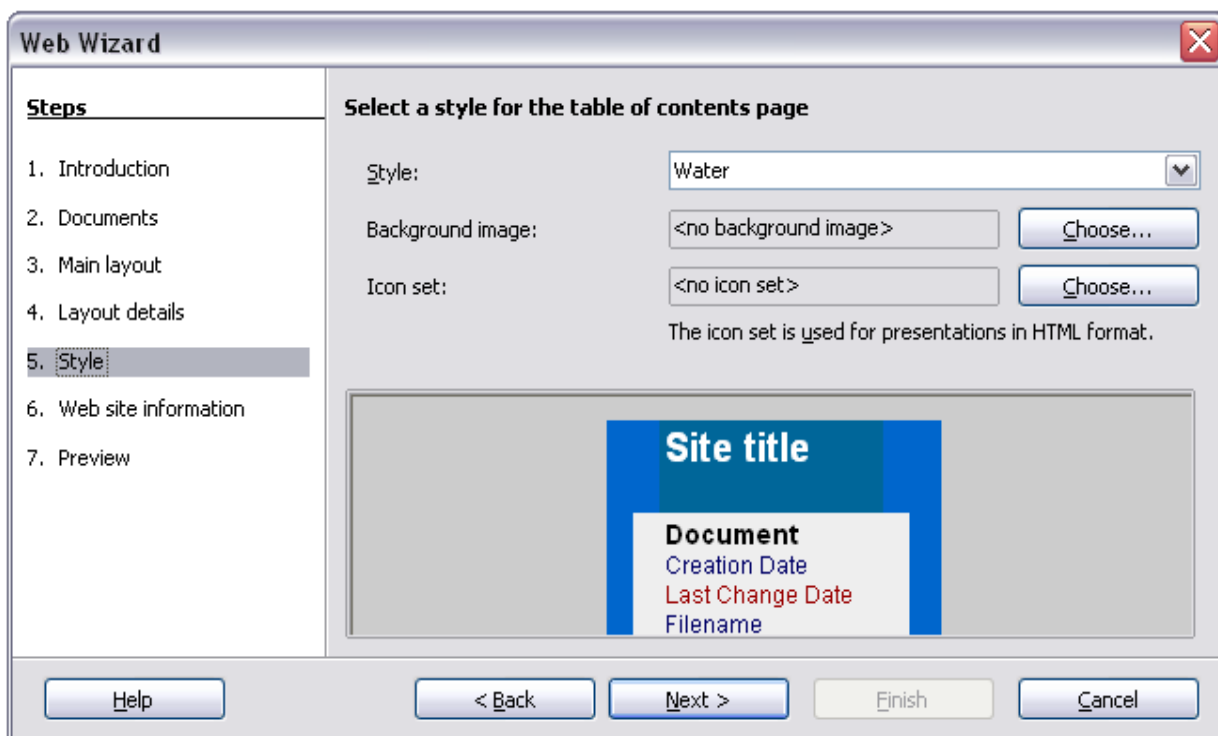

- 6) Enter general information such as Title and HTML Metadata information. Click **Next**.

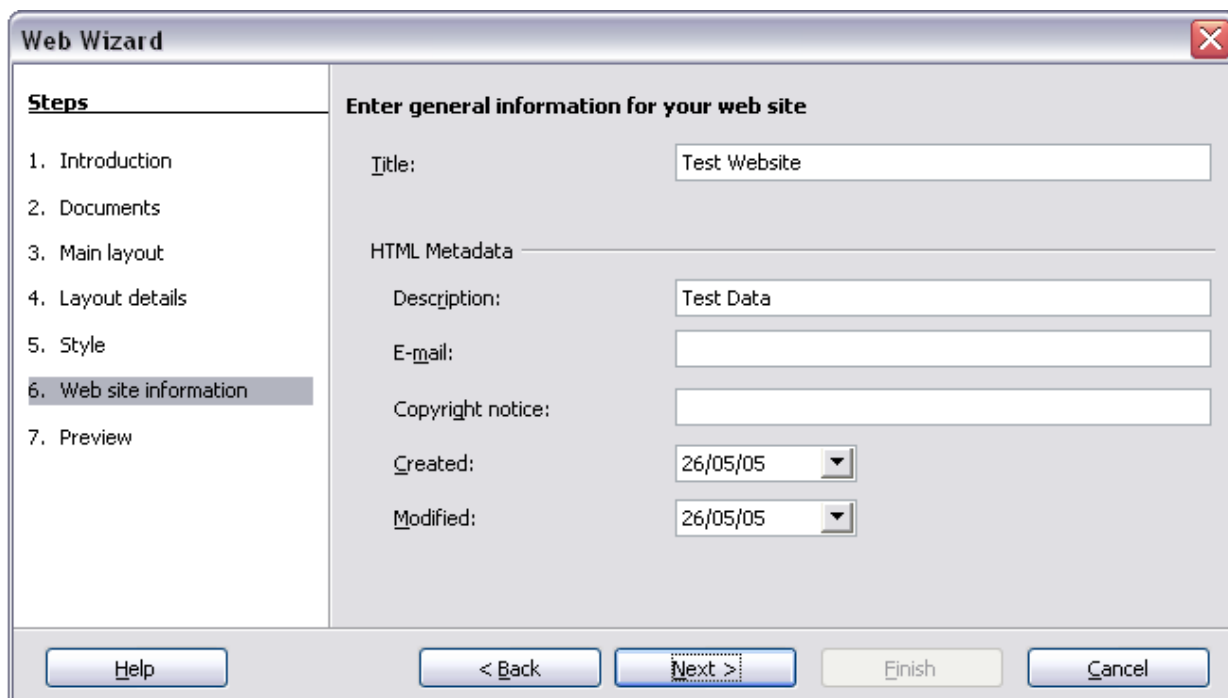

- 7) Chose where to save the file and preview the page if you wish. Click **Finish**.

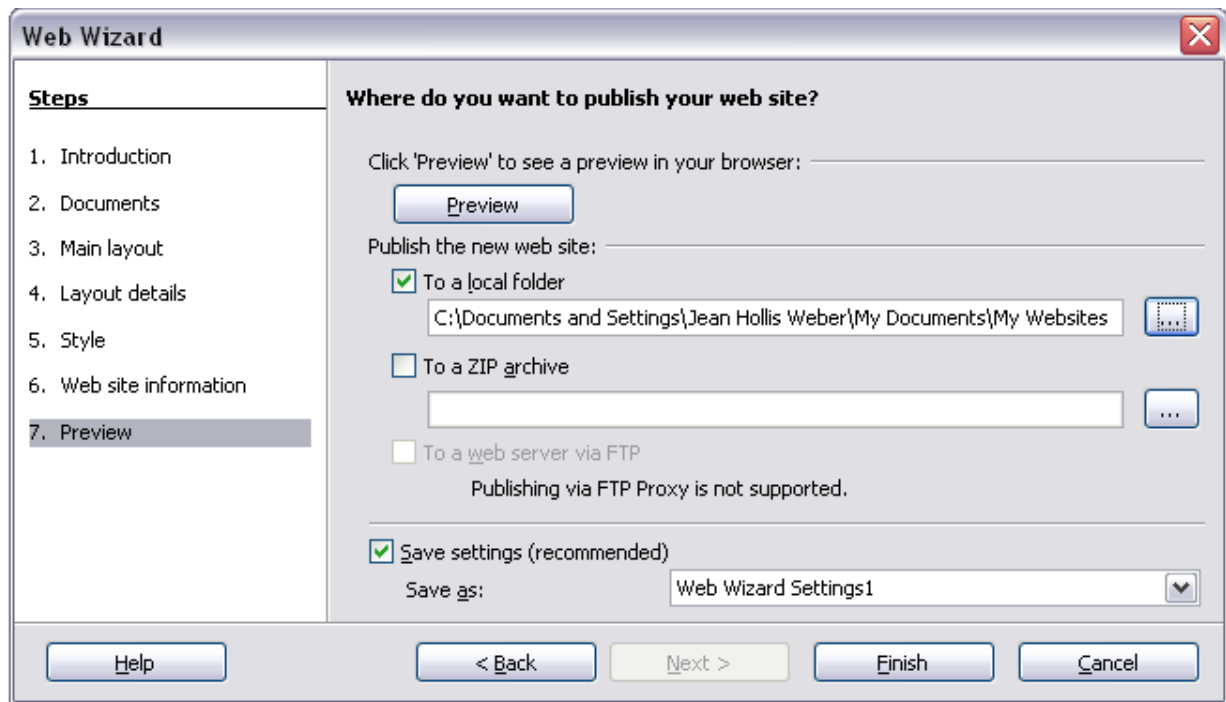

To edit or view the document's underlying HTML code, open the document, and then choose **View > HTML Source** or click the **HTML Source** icon  on the Main toolbar.

Saving Calc spreadsheets as web pages

Calc can save files as HTML documents. As for Writer, choose **File > Save As** and select **HTML Document**, or choose **File > Wizards > Web Page**.

If the file contains more than one sheet, the additional sheets will follow one another in the HTML file. Links to each sheet will be placed at the top of the document. Calc also allows the insertion of links directly into the spreadsheet using the Hyperlink dialog.

Saving Impress presentations as web pages

You can export presentations as Macromedia Flash files: choose **File > Export** and select Macromedia Flash for the file type.

You can also convert presentations into a series of web pages, as described below.

Note

Saving as web pages (HTML format) does not retain animation and slide transitions.

- 1) To begin, choose **File > Export** and select **HTML Document** as the file type.
- 2) Create a folder for the files, supply a name for the resulting HTML file, and click **Save**. The HTML Export Wizard opens.

Note

Depending on the size of your presentation and the number of graphics it contains, the HTML export function may create many HTML, JPG, and GIF files. If you simply save to your desktop (not in a specific folder), these separate HTML and graphics files will be all over your desktop. So be sure to create a folder to hold all the files.

- 3) Choose the design for all of the pages, either from an existing design or by creating a new one. If you have not previously saved a design, the *Existing Design* choice is not available.

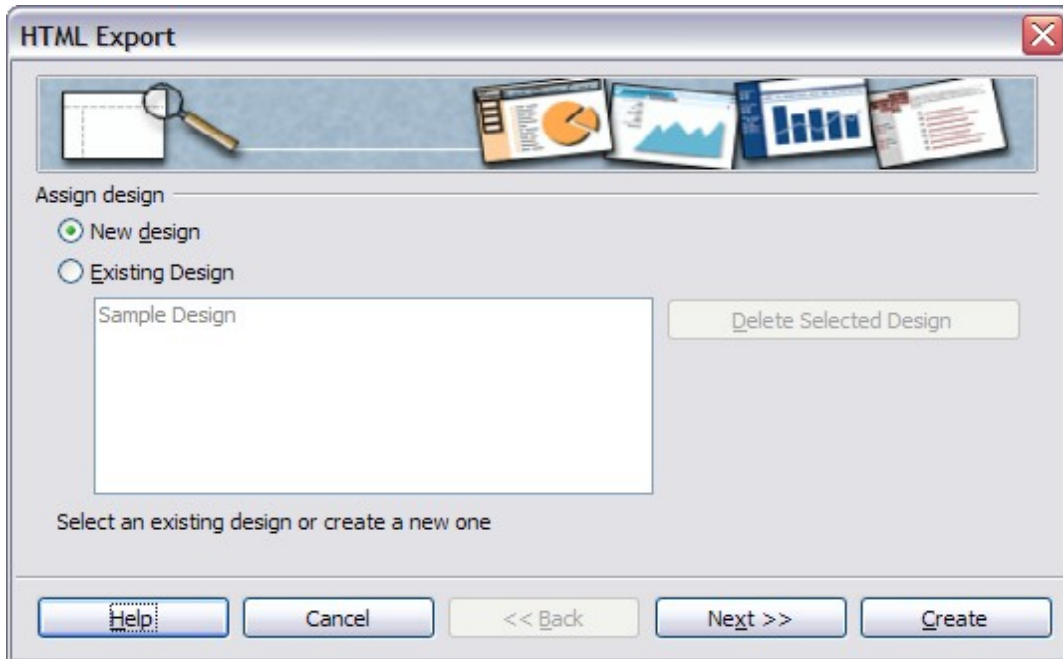

- 4) Click **Next** to select the type of web pages to create.
- *Standard HTML*: one page for each slide, with navigation links to move from slide to slide.
 - *Standard HTML with frames*: one page with a navigation bar on the left-hand side; uses slide title as navigation links. Click on links to display pages in right-hand side.
 - *Automatic*: one page for each slide, with each page set with the Refresh meta tag so a browser automatically cycles from one page to the next.
 - *WebCast*: generates an ASP or Perl application to display the slides. Unfortunately OOo has no direct support for PHP yet.

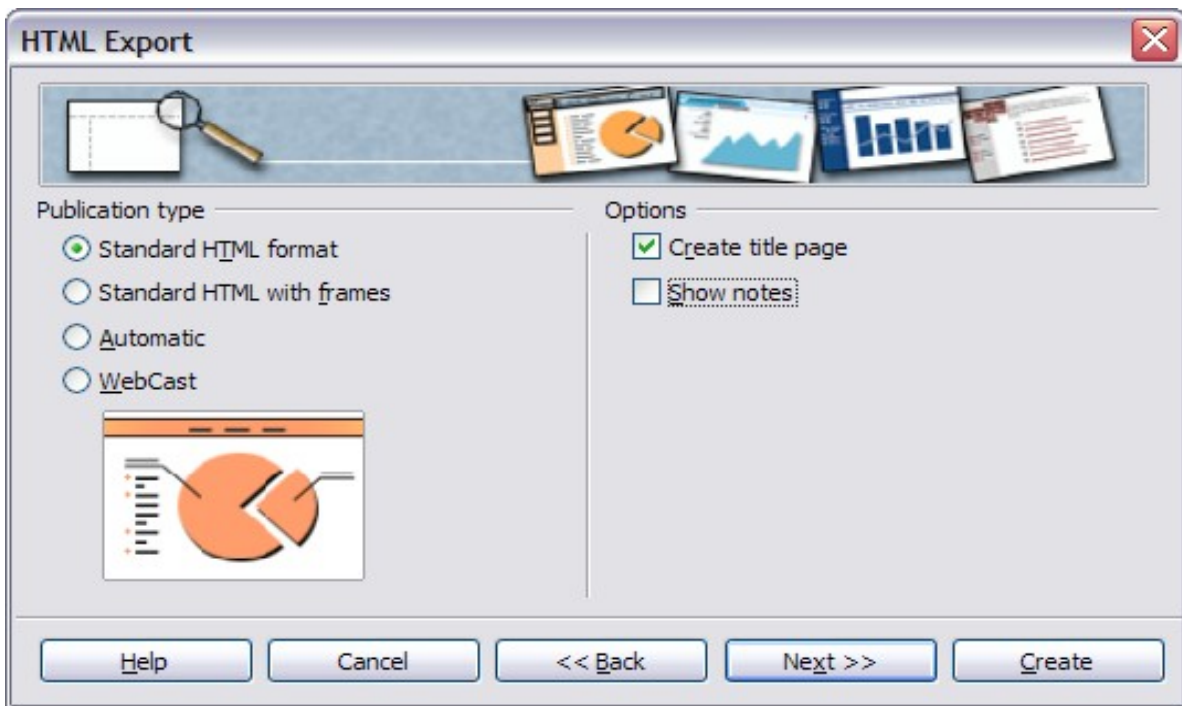

- 5) Decide how the images will be saved (PNG, GIF, or JPG) and what resolution to use.

When choosing a resolution, consider what the majority of your viewers might be using. If you specify a high resolution, then a viewer with a medium-resolution monitor will have to scroll sideways to see the entire slide, which is probably not desirable.

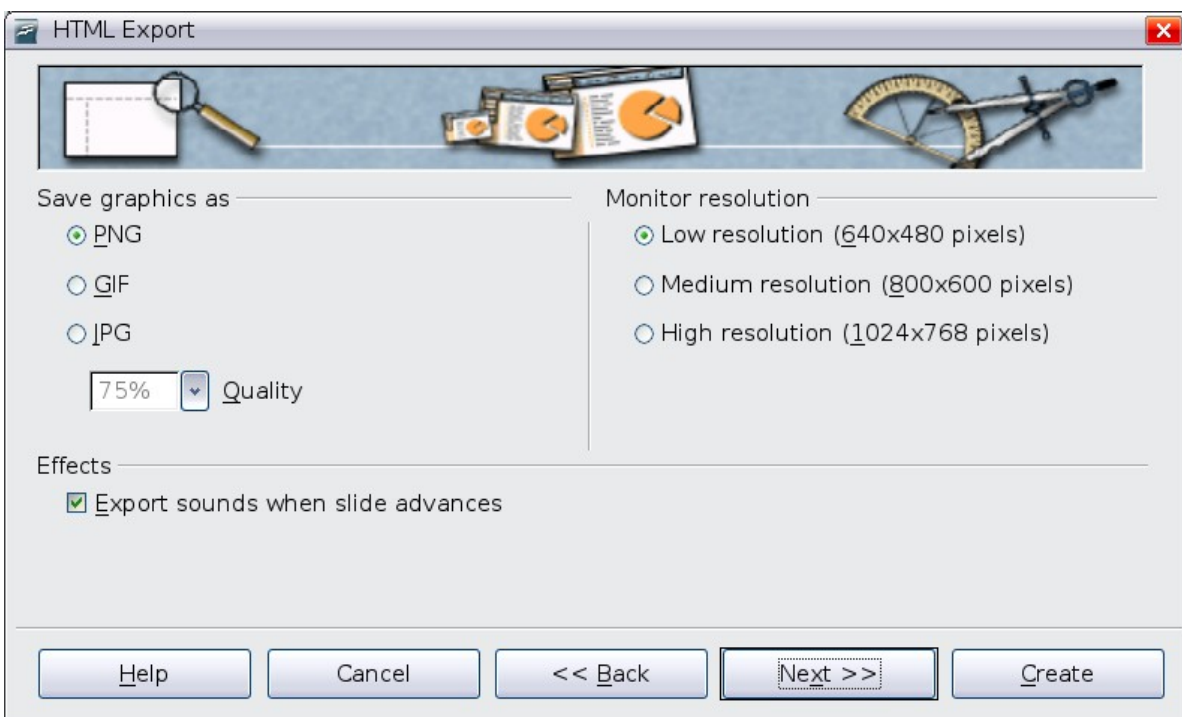

- 6) If *Create title page* was chosen in step 4, supply the information for it on the next page. The title contains an author name, e-mail address and home page, along with any additional information you want to include.

This page of the Wizard does not display if *Create title page* was not chosen.

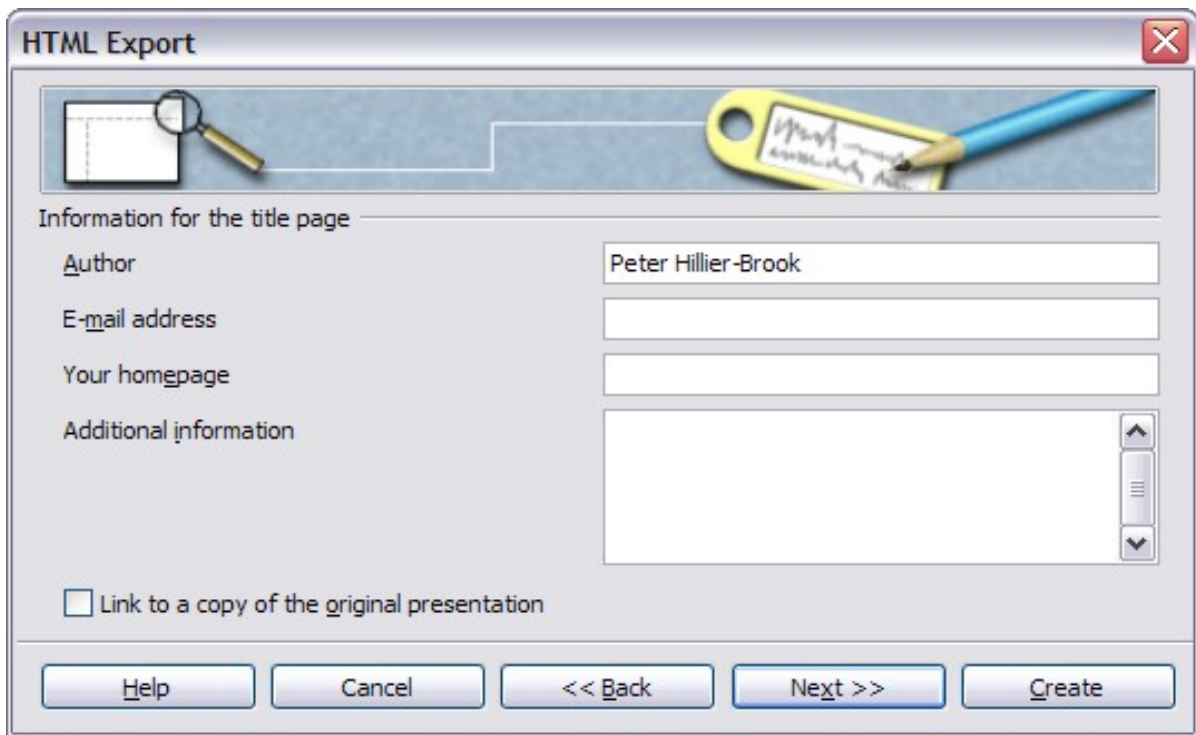

- 7) Choose the navigation button style to use to move from one page to another. If you do not choose any, OOO will create a text navigator.

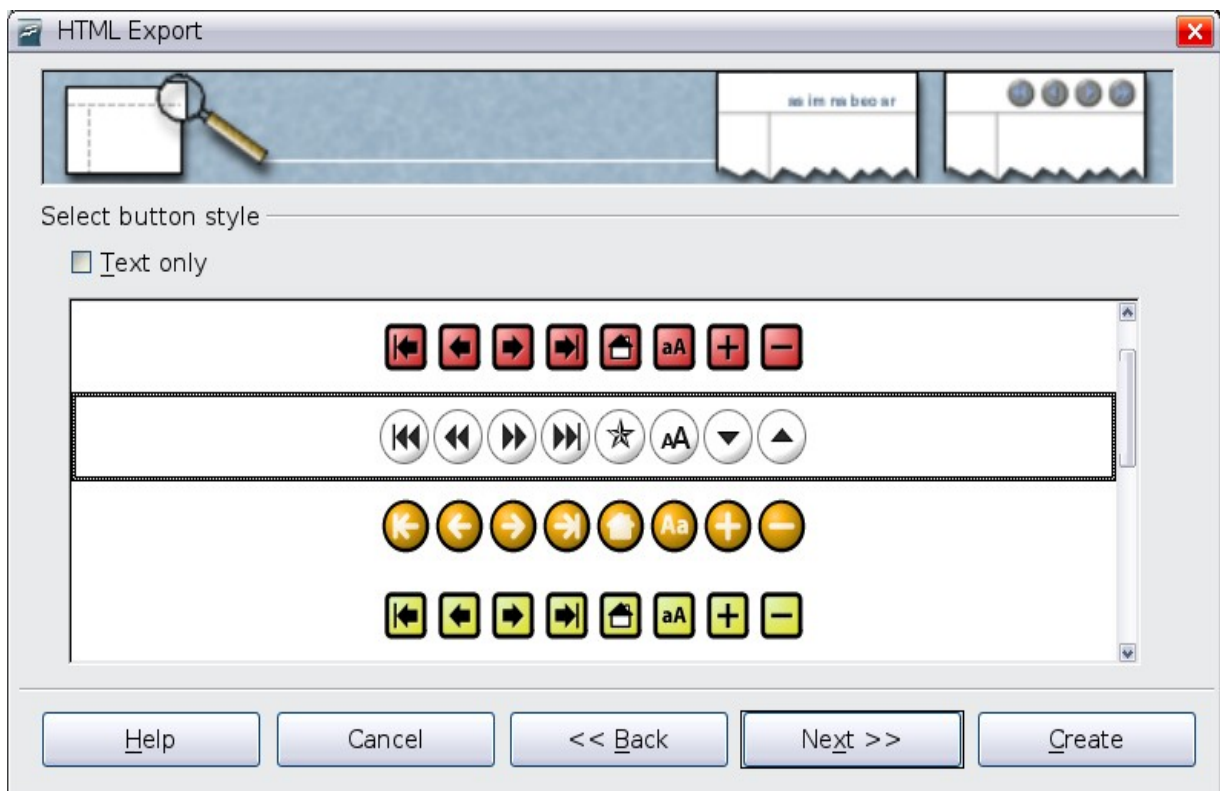

- 8) Select the color scheme for the web pages. Available schemes include the document's existing scheme, one based upon browser colors, and a completely user-defined scheme. You can save a new scheme so that it will appear on the first page of the HTML export wizard.

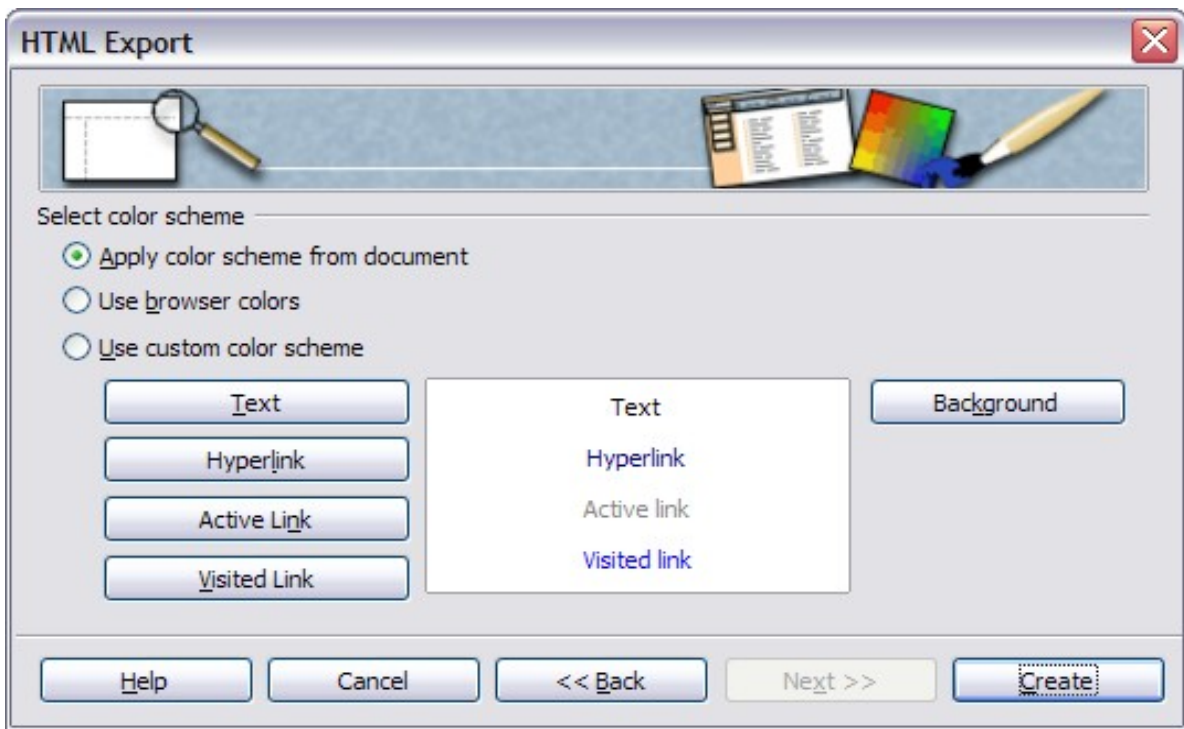

- 9) Click **Create** to generate the HTML files. If this is a new design, a small dialog pops up. If you might want to reuse this design, you can give it a name and save it. Otherwise, click **Do Not Save**.

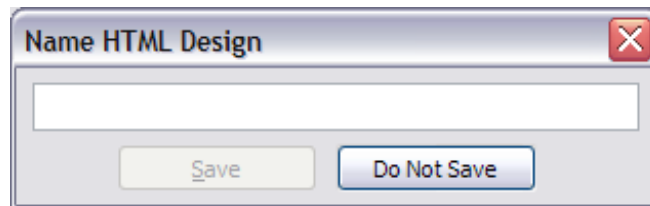

Saving Draw documents as web pages

Exporting drawings from OpenOffice.org's Draw application is similar to exporting a presentation from Impress. Choose **File > Export** and select **HTML Document** as the file type.

When using the wizard, you can choose to create the web page at any time by clicking the **Create** button.

Chapter 13

Getting Started with Macros

Using the Macro Recorder

Your first macros

A macro is a saved sequence of commands or keystrokes that are stored for later use. An example of a simple macro is one that “types” your address. The OpenOffice.org macro language is very flexible, allowing automation of both simple and complex tasks. Macros are especially useful to repeat a task the same way over and over again.

OpenOffice.org macros are usually written in a language called StarBasic, or just abbreviated Basic. Although you can learn Basic and write macros, there is a steep learning curve to writing macros from scratch. The usual methods for a beginner are to add macros that someone else has written and to use the built-in macro recorder, which records your keystrokes and saves them for use.

Most tasks in OpenOffice.org are accomplished by “dispatching a command” (sending a command), which is intercepted and used. The macro recorder works by recording the commands that are dispatched (see “The dispatch framework” on page 332).

Adding an existing macro

The first step in learning macro programming is to find and use existing macros. This section assumes that you have a macro that you want to use; the macro may be in an email, on a web page, or even in a book. For this example, use the macro in Listing 1.

Listing 1: Simple macro that says hello.

```
Sub HelloMacro
  Print "Hello"
End Sub
```

You must create a library and module to contain your macro; this is covered in “Macro organization” on page 333. Use these steps to create a library to contain your macro:

- 1) Use **Tools > Macros > Organize Macros > OpenOffice.org Basic** to open the OOO Macro dialog (see Figure 300 and Figure 305).
- 2) Click Organizer to open the OOO Basic Macro Organizer dialog (see Figure 306).
- 3) Select the *Libraries* tab.
- 4) Set the *Location* to *My Macros & Dialogs*, which is the default.
- 5) Click **New** to open the New Library dialog. Enter a library name such as “TestLibrary” and click **OK**.
- 6) Select the *Modules* tab.
- 7) In the *Module* list, expand *My Macros* and select TestLibrary. A module named Module1 already exists and can contain your macro. You can click **New** to create another module in TestLibrary.
- 8) Select the Module1, or the new module that you created, and click **Edit** to open the OOO Integrated Debugging Environment (IDE).
- 9) The IDE is a text editor for macros that allows you to edit and create macros. Copy the macro into the IDE.

When a new module is created, it contains a comment and an empty macro named Main, that does nothing.

Listing 2: Contents of Module1 after it is created.

```
REM ***** BASIC *****
```

```
Sub Main
```

```
End Sub
```

Add the new macro either before Sub Main or after End Sub. In Listing 3, the new macro has been added before Sub Main.

Listing 3: Module1 after adding the new macro.

```
REM ***** BASIC *****
```



```
Sub HelloMacro
```

```
Print "Hello"
```

```
End Sub
```

```
Sub Main
```

```
End Sub
```

Click on the Run Basic button  in the toolbar to run the first macro in the module. Use the Macro dialog, opened using the Select macro button  or **Tools > Macros > Organize Macros > OpenOffice.org Basic**, to select and run any macro in the module.

Creating a simple macro

Imagine repeatedly entering simple information. Although you can store the information in the clipboard, if you use the clipboard for something else, the contents are changed. Storing the contents as a macro is a simple solution. (In some simple cases, including the example used here, a better solution is to use AutoText.)

- 1) Use **Tools > Macros > Record Macro** to start recording a macro.

A small window is displayed so you know that OpenOffice.org is recording.



- 2) Type the desired information or perform an appropriate series of operations. In this case, I typed my name, *Andrew Pitonyak*.
- 3) Click the **Stop Recording** button to stop recording, save the macro, and display the OpenOffice.org Basic Macros dialog.

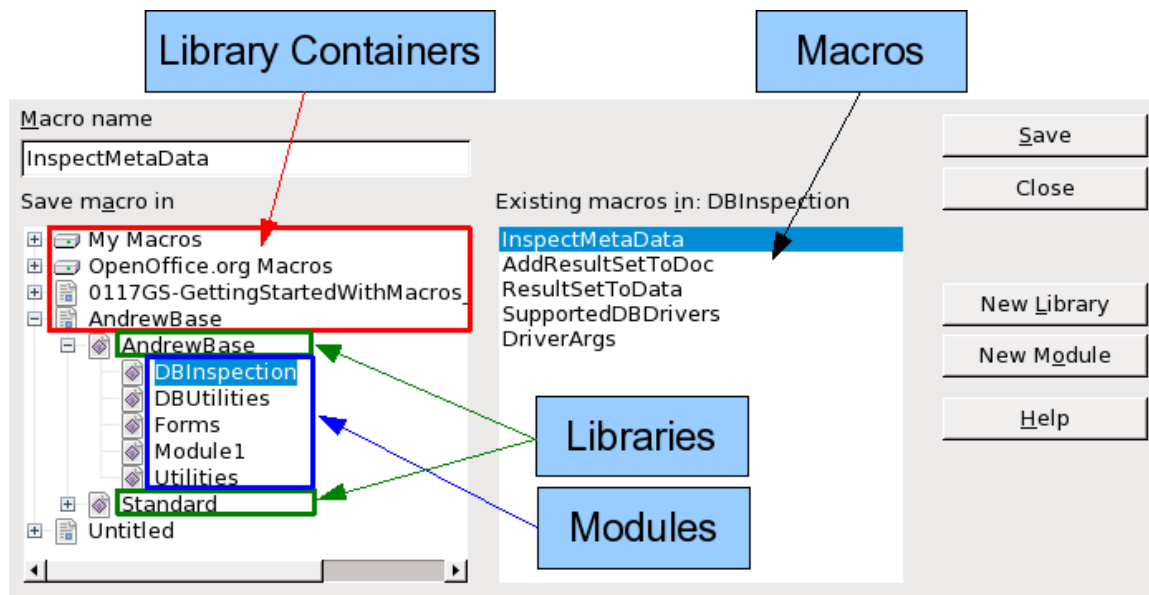

Figure 300: OOO Macro Organizer dialog, DBInspection library selected

- 4) Be certain to open the library container named *My Macros*. Find the library named *Standard* under *My Macros*. Be warned, *every* library container has a library named *Standard*. Select the *Standard* library and click **New Module** to create a new module to contain the macro.
- 5) The default module name is *Module1*. Type a descriptive name and click **OK** to create the module. The OpenOffice.org Basic Macros dialog is displayed again, showing the new module.



Figure 301: Give your module a meaningful name

- 6) Highlight the newly created module. In the upper left corner, type the macro name to use, such as “EnterMyname”, and then click **Save** to save the macro.

If you followed all of the steps, the *Standard* library now contains a module named *Recorded*, which contains the *EnterMyName* macro, as shown in Figure 302. When OOO creates a new module, it automatically adds the macro named *Main*.

Running the macro

Use **Tools > Macros > Run Macro** to open the Macro Selector dialog. Select the newly created macro and click **Run**.

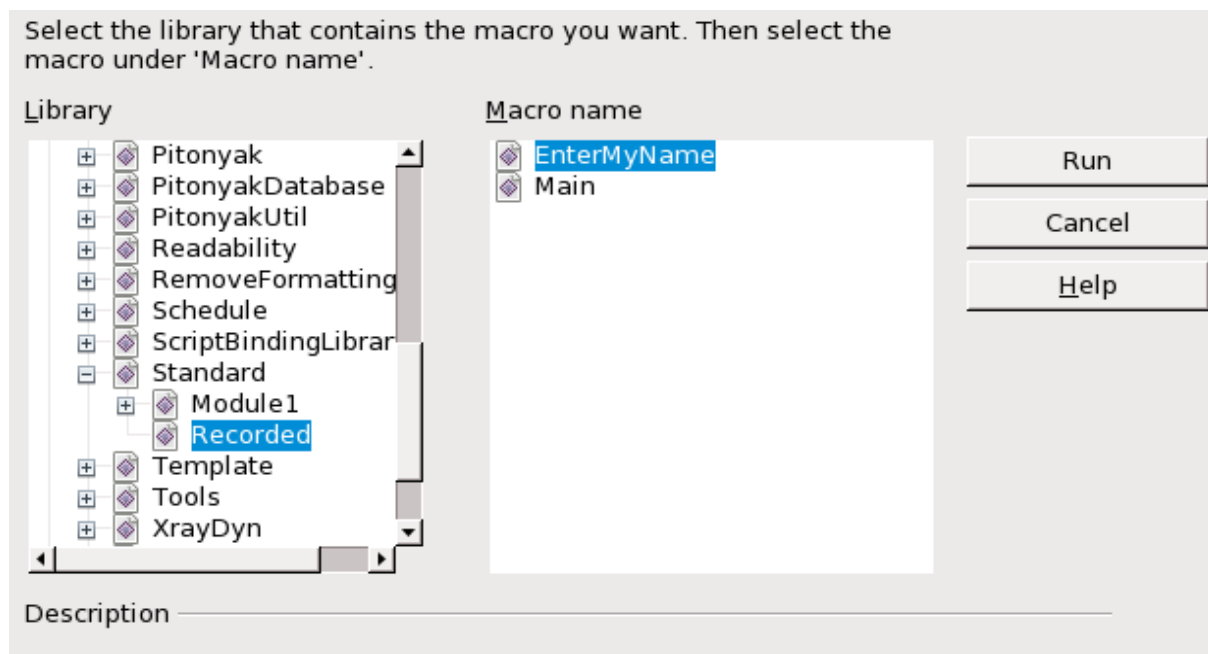

Figure 302: Select your macro and click Run

There are other methods to run a macro. For example, use **Tools > Macros > Organize Macros > OpenOffice.org Basic** to open the macro organizer, which contains a **Run** button as well. Another method is to use the macro organizer; the dialog usually opens faster, but the selection process may be slightly slower.

Viewing and editing the macro

You can view and edit the macro that was just created. Use **Tools > Macros > Organize Macros > OpenOffice.org Basic** to open the OpenOffice.org Basic Macros dialog (see Figure 302). Select the new macro and click **Edit** to open the macro in the Basic IDE (Integrated Development Environment).

Listing 4: Generated "EnterMyname" macro.

```
REM ***** BASIC *****
Sub Main

End Sub

sub EnterMyName
rem -----
rem define variables
dim document as object
dim dispatcher as object
rem -----
rem get access to the document
document = ThisComponent.CurrentController.Frame
dispatcher = createUnoService("com.sun.star.frame.DispatchHelper")

rem -----
dim arg1(0) as new com.sun.star.beans.PropertyValue
arg1(0).Name = "Text"
arg1(0).Value = "Andrew Pitonyak"
```

```
dispatcher.executeDispatch(document, ".uno:InsertText", "", 0, args1())  
end sub
```

The macro in Listing 4 is not as complicated as it first appears. Learning a few things helps significantly in understanding the generated macros. The discussion starts with features near the top of the macro listing and describes them. If you like to avoid details, then simply change the text “Andrew Pitonyak” in the macro above to what you want to insert at the current cursor position.

Comments start with REM

The keyword REM, short for *remark*, starts a macro comment. All text after REM (on the same line) is ignored. As a short cut, the single quote character can also be used to start a comment.

Tip

StarBasic is not case-sensitive for keywords, so REM, Rem, and rem all start a comment. If you use symbolic constants defined by the API, it is safer to assume that the names are case-sensitive—symbolic constants are an advanced topic not usually needed by people that use the macro recorder.

Defining subroutines with SUB

Individual macros are stored in subroutines defined with the keyword SUB. The end of a subroutine is indicated by the words END SUB. The code starts by defining the subroutine named Main, which is empty and does nothing. The next subroutine, EnterMyName, contains the generated code.

Tip

OpenOffice.org always creates an empty subroutine named Main when it creates a module.

There are advanced topics that are beyond the scope of this document, but knowing about them might be of interest:

- You can write a macro so that values can be passed to the subroutine. The values are called arguments. Recorded macros do not accept arguments.
- Another kind of subroutine is called a function. A function is a subroutine that returns a value. The keyword FUNCTION is used rather than SUB to define a function. Generated macros are always of type SUB.

Defining variables using DIM

You can write information on a piece of paper so that you can look at it later. A variable, like a piece of paper, contains information that can be changed and read. The DIM statement is similar to setting aside a piece of paper to be used to store a message or note.

The EnterMyName macro defines the variables *document* and *dispatcher* as type *object*. Other common variable types include *string*, *integer*, and *date*. A third variable, named *args1*, is an array of property values. A variable of type *array* allows a single variable to contain multiple values, similar to storing multiple pages in a single book. Values in an array are usually numbered starting from zero. The number in the parentheses indicates the highest usable number to access a storage location. In this example, there is only one value, and it is numbered zero.

Pulling the macro together

The following details are very complete; it is not important to understand all of the details. The first line defines the start of the macro.

```
sub EnterMyName
```

Declare two variables:

```
dim document as object
```

```
dim dispatcher as object
```

ThisComponent refers to the current document.

The CurrentController property of a document refers to a service that “controls” the document. For example, when you type, it is the current controller that notices. The current controller then dispatches the changes to the document’s frame.

The Frame property of a controller returns a main frame for a document. Therefore, the variable named *document* refers to a document’s frame, which receives dispatched commands.

```
document = ThisComponent.CurrentController.Frame
```

Most tasks in OpenOffice.org are accomplished by dispatching a command. OOO includes a dispatch helper service, which does most of the work to use dispatches in macros. The method CreateUnoService accepts the name of a service and it tries to create an instance of that service. On completion, the dispatcher variable contains a reference to a DispatchHelper.

```
dispatcher = createUnoService("com.sun.star.frame.DispatchHelper")
```

Declare an array of properties. Each property has a name and a value. In other words, it is a name/value pair. The created array has one property at index zero.

```
dim args1(0) as new com.sun.star.beans.PropertyValue
```

Give the property the name “Text” and the value “Andrew Pitonyak”, which is the text that is inserted when the macro is run.

```
args1(0).Name = "Text"
```

```
args1(0).Value = "Andrew Pitonyak"
```

This is where the magic happens. The dispatch helper sends a dispatch to the document’s frame (stored in the variable named document) with the command `.uno:InsertText`. The next two arguments, *frame name* and *search flags*, are beyond the scope of this document. The last argument is the array of property values to be used while executing the command `InsertText`.

```
dispatcher.executeDispatch(document, ".uno:InsertText", "", 0, args1())
```

Finally, the end of the subroutine.

```
end sub
```

Creating a macro

When creating a macro, it is important to ask two questions before recording:

- 1) Can the task be written as a simple set of commands?
- 2) Can the steps be arranged such that the last command leaves the cursor ready for the next command?

A complicated example

I frequently copy rows and columns of data from a web site and format them as a table in a text document. First, I copy the table from the web site to the clipboard. To avoid strange formatting and fonts, I paste the text into a Writer document as unformatted text. I reformat the text with tabs between columns so that I can use **Table > Convert > Text to Table** to convert to a table.

I inspect the text to see if I can record a macro to format the text (remember the two questions that I ask). As an example, I copied the FontWeight constants group from the OpenOffice.org web site. The first column indicates the constant name. Each name is followed by a space and a tab.

DONTKNOW	The font weight is not specified/known.
THIN	specifies a 50% font weight.
ULTRALIGHT	specifies a 60% font weight.
LIGHT	specifies a 75% font weight.
SEMILIGHT	specifies a 90% font weight.
NORMAL	specifies a normal font weight.
SEMIBOLD	specifies a 110% font weight.
BOLD	specifies a 150% font weight.
ULTRABOLD	specifies a 175% font weight.
BLACK	specifies a 200% font weight.

I want the first column to contain the numeric value, the second column the name, and the third column the description. The desired work is easily accomplished for every row except for DONTKNOW and NORMAL, which do not contain a numeric value—but I know that the values are 0 and 100, so I will enter those manually.

The data can be cleaned in multiple ways—all of them easy. The first example uses keystrokes that assume the cursor is at the start of the line with the text THIN.

- 1) Use **Tools > Macros > Record Macro** to start recording.
- 2) Press *Ctrl+Right Arrow* to move the cursor to the start of “specifies”.
- 3) Press *Backspace* twice to remove the tab and the space.
- 4) Press *Tab* to add the tab without the space after the constant name.
- 5) Press *Delete* to delete the lower case s and then press *S* to add an upper case S.
- 6) Press *Ctrl+Right Arrow* twice to move the cursor to the start of the number.
- 7) Press *Ctrl+Shift+Right Arrow* to select and move the cursor before the % sign.
- 8) Press *Ctrl+C* to copy the selected text to the clipboard.
- 9) Press *End* to move the cursor to the end of the line.
- 10) Press *Backspace* twice to remove the two trailing spaces.
- 11) Press *Home* to move the cursor to the start of the line.
- 12) Press *Ctrl+V* to paste the selected number to the start of the line.
- 13) Pasting the value also pasted an extra space, so press *Backspace* to remove the extra space.

- 14) Press *Tab* to insert a tab between the number and the name.
- 15) Press *Home* to move to the start of the line.
- 16) Press *down arrow* to move to the next line.
- 17) Stop recording the macro and save the macro.

It takes much longer to read and write the steps than to record the macro. Work slowly and think about the steps as you do them. With practice this becomes second nature.

The generated macro has been modified to contain the step number in the comments to match the code to the step above.

Listing 5: Copy the numeric value to the start of the column.

```

sub CopyNumToCol1
rem -----
rem define variables
dim document as object
dim dispatcher as object
rem -----
rem get access to the document
document = ThisComponent.CurrentController.Frame
dispatcher = createUnoService("com.sun.star.frame.DispatchHelper")

rem (2) Press Ctrl+Right Arrow to move the cursor to the start of
"specifies".
dispatcher.executeDispatch(document, ".uno:GoToNextWord", "", 0, Array())

rem (3) Press Backspace twice to remove the tab and the space.
dispatcher.executeDispatch(document, ".uno:SwBackspace", "", 0, Array())

rem -----
dispatcher.executeDispatch(document, ".uno:SwBackspace", "", 0, Array())

rem (4) Press Tab to add the tab without the space after the constant name.
dim args4(0) as new com.sun.star.beans.PropertyValue
args4(0).Name = "Text"
args4(0).Value = CHR$(9)

dispatcher.executeDispatch(document, ".uno:InsertText", "", 0, args4())

rem (5) Press Delete to delete the lower case s ....
dispatcher.executeDispatch(document, ".uno>Delete", "", 0, Array())

rem (5) ... and then press S to add an upper case S.
dim args6(0) as new com.sun.star.beans.PropertyValue
args6(0).Name = "Text"
args6(0).Value = "S"

dispatcher.executeDispatch(document, ".uno:InsertText", "", 0, args6())

rem (6) Press Ctrl+Right Arrow twice to move the cursor to the number.
dispatcher.executeDispatch(document, ".uno:GoToNextWord", "", 0, Array())

rem -----
dispatcher.executeDispatch(document, ".uno:GoToNextWord", "", 0, Array())

```

```

rem (7) Press Ctrl+Shift+Right Arrow to select the number.
dispatcher.executeDispatch(document, ".uno:WordRightSel", "", 0, Array())

rem (8) Press Ctrl+C to copy the selected text to the clipboard.
dispatcher.executeDispatch(document, ".uno:Copy", "", 0, Array())

rem (9) Press End to move the cursor to the end of the line.
dispatcher.executeDispatch(document, ".uno:GoToEndOfLine", "", 0, Array())

rem (10) Press Backspace twice to remove the two trailing spaces.
dispatcher.executeDispatch(document, ".uno:SwBackspace", "", 0, Array())

rem -----
dispatcher.executeDispatch(document, ".uno:SwBackspace", "", 0, Array())

rem (11) Press Home to move the cursor to the start of the line.
dispatcher.executeDispatch(document, ".uno:GoToStartOfLine", "", 0, Array())

rem (12) Press Ctrl+V to paste the selected number to the start of the line.
dispatcher.executeDispatch(document, ".uno:Paste", "", 0, Array())

rem (13) Press Backspace to remove the extra space.
dispatcher.executeDispatch(document, ".uno:SwBackspace", "", 0, Array())

rem (14) Press Tab to insert a tab between the number and the name.
dim args17(0) as new com.sun.star.beans.PropertyValue
args17(0).Name = "Text"
args17(0).Value = CHR$(9)

dispatcher.executeDispatch(document, ".uno:InsertText", "", 0, args17())

rem (15) Press Home to move to the start of the line.
dispatcher.executeDispatch(document, ".uno:GoToStartOfLine", "", 0, Array())

rem (16) Press down arrow to move to the next line.
dim args19(1) as new com.sun.star.beans.PropertyValue
args19(0).Name = "Count"
args19(0).Value = 1
args19(1).Name = "Select"
args19(1).Value = false

dispatcher.executeDispatch(document, ".uno:GoDown", "", 0, args19())
end sub

```

Cursor movements are used for all operations (as opposed to searching). If run on the DONTKNOW line, the word *weight* is moved to the front of the line, and the first “The” is changed to “She”. This is not perfect, but I should not have run the macro on the lines that did not have the proper format; I need to do these manually.

Running the macro quickly

It is tedious to repeatedly run the macro using **Tools > Macros > Run Macro** (see Figure 302). The macro can be run from the IDE. Use **Tools > Macros > Organize Macros > OpenOffice.org Basic** to open the Basic Macro dialog. Select your macro and click **Edit** to open the macro in the IDE.

The IDE has a **Run Basic** icon in the toolbar that runs the first macro in the IDE. Unless you change the first macro, it is the empty macro named Main. Modify Main so that it reads as shown in Listing 6.

Listing 6: Modify Main to call CopyNumToCol1.

```
Sub Main
  CopyNumToCol1
End Sub
```

Now, you can run CopyNumToCol1 by repeatedly clicking the **Run Basic** icon in the toolbar of the IDE. This is very fast and easy, especially for temporary macros that will be used a few times and then discarded.

Sometimes the macro recorder fails

Understanding the OpenOffice.org internals helps to understand how and why the macro recorder frequently fails. The primary offender is related to the dispatch framework and its relationship to the macro recorder.

The dispatch framework

The purpose of the dispatch framework is to provide a uniform access to components (documents) for commands that usually correspond to menu items. I can use **File > Save** from the menu, the shortcut keys *Ctrl+S*, or click on the **Save** toolbar icon. All of these commands are translated into the same “dispatch command”, which is sent to the current document.

The dispatch framework can also be used to send “commands” back to the UI (User Interface). For example, after saving the document, the File Save command is disabled. As soon as the document has been changed, the File Save command is enabled.

If we see a dispatch command, it is text such as `.uno:InsertObject` or `.uno:GoToStartOfLine`. The command is sent to the document’s frame, and the frame passes on the command until an object is found that can handle the command.

How the macro recorder uses the dispatch framework

The macro recorder records the generated dispatches. The recorder is relatively simple to implement and the same commands that are issued are recorded for later use. The problem is that not all dispatched commands are complete. For example, inserting an object generates the following code:

```
dispatcher.executeDispatch(document, ".uno:InsertObject", "", 0, Array())
```

It is not possible to specify what kind of object to create or insert. If an object is inserted from a file, you cannot specify which file to insert.

I recorded a macro and used **Tools > Options** to open and modify configuration items. The generated macro does not record any configuration changes; in fact, the generated code is commented so it will not even be run.

```
rem dispatcher.executeDispatch(document,
  ".uno:OptionsTreeDialog", "", 0, Array())
```

If a dialog is opened, the command to open the dialog is likely to be generated. Any work done inside the dialog is not usually recorded. Examples include macro

organization dialogs, inserting special characters, and similar types of dialogs. Other possible problems using the macro recorder include things such as inserting a formula, setting user data, setting filters in Calc, actions in database forms, and exporting a document to an encrypted PDF file. You never know for certain what will work unless you try it, however. The actions from the search dialog are properly captured, for example.

Other options

When the macro recorder is not able to solve a specific problem, the usual solution is to write code using the OpenOffice.org objects. Unfortunately, there is a steep learning curve for the OOO objects. It is usually best to start with simple examples and then branch out slowly as you learn more. Learning to read generated macros is a good place to start.

If you record Calc macros, and the recorder can correctly generate a macro, there is an add-in created by Paolo Mantovani, which converts Calc macros when they are recorded. The final code manipulates OpenOffice.org objects rather than generating dispatches. This can be very useful for learning the object model.

You can download the macro recorder from Paolo's web site directly or from the OOO Macros web site. You should check both places to see which contains the latest version.

<http://www.paolo-mantovani.org/downloads/DispatchToApiRecorder/>

<http://www.oocomacros.org/user.php>

Macro organization

In OpenOffice.org, macros are grouped in modules, modules are grouped in libraries, and libraries are grouped in library containers. A library is usually used as a major grouping for either an entire category of macros, or for an entire application. Modules usually split functionality, such as user interaction and calculations. Individual macros are subroutines and functions.

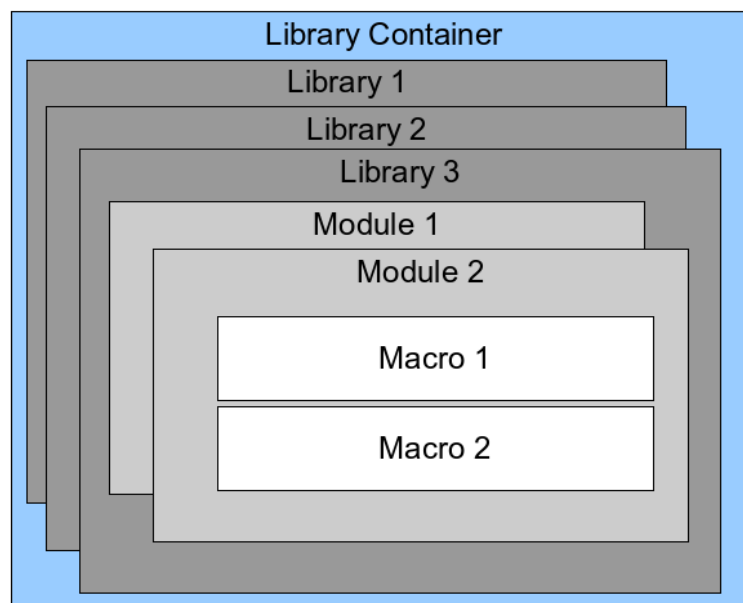

Figure 303: Macro Library hierarchy

A computer scientist would use Figure 304 to precisely describe the situation. The text “1..*” means one or more, and “0..*” means zero or more. The black triangle means composed of or contains.

- A library container contains one or more libraries, and each library is contained in one library container.
- A library contains zero or more modules, and each module is contained in one library.
- A module contains zero or more macros, and each macro is contained in one module.

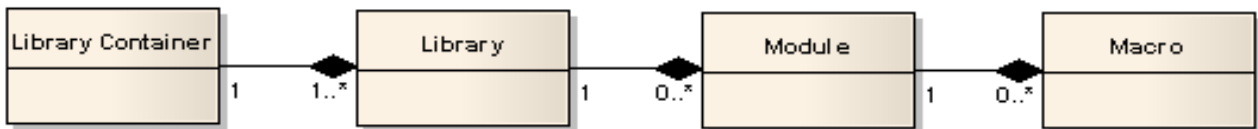

Figure 304: Macro Library hierarchy

Use **Tools > Macros > Organize Macros > OpenOffice.org Basic** to open the OpenOffice.org Basic Macros dialog (see Figure 305). All available library containers are shown in the *Macro from* list. Every document is a library container, capable of containing multiple libraries. The application itself acts as two library containers, one container for macros distributed with OpenOffice.org called OpenOffice.org Macros, and one container for personal macros called My Macros. As shown in Figure 305, only two documents are currently open.

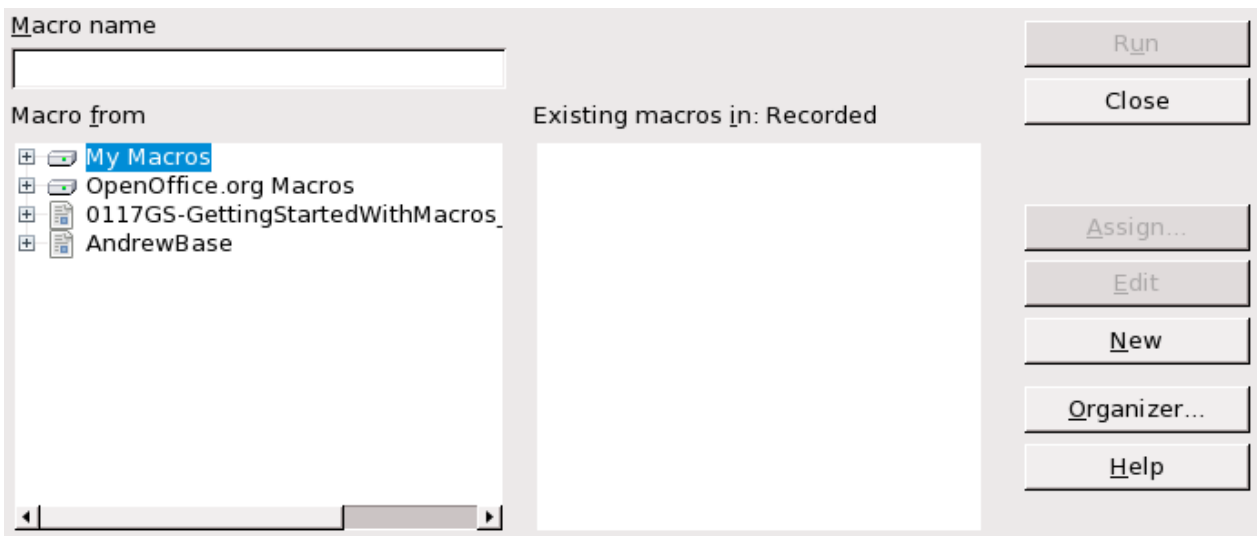

Figure 305: Library containers are shown on the left

The OpenOffice.org Macros are stored with the application runtime code, which may not be editable to you unless you are an administrator. This is just as well since these macros should not be changed and you should not store your own macros in the OOo container.

Unless your macros are applicable to a single document, and only to a single document, your macros will probably be stored in the My Macros container. The My Macros container is stored in your user area or home directory.

If a macro is contained in a document, then a recorded macro will attempt to work on that document; primarily because it uses “ThisComponent” for its actions.

Every library container contains a library named *Standard*. It is better to create your own libraries with meaningful names than to use the Standard library. Not only are meaningful names easier to manage, but they can also be imported into other library containers whereas the Standard library cannot.

Caution

OpenOffice.org allows you to import libraries into a library container, but it will not allow you to overwrite the library named Standard. Therefore, if you store your macros in the Standard library, you cannot import them into another library container.

Just as it makes good sense to give your libraries meaningful names, it is prudent to use meaningful names for your modules. By default, OpenOffice.org uses names such as Module1. Feel free to use your own meaningful name.

As you create your macros, you must decide where to store them. Storing a macro in a document is useful if the document will be shared and you want the macro to be included with the document. Macros stored in the application library container named My Macros, however, are globally available to all documents.

Macros are not available until the library that contains them is loaded. The Standard library and Template library, however, are automatically loaded. A loaded library is displayed differently from a library that is not loaded. To load the library and the modules it contains, double-click on the library.

Where are macros stored?

OpenOffice.org stores user-specific data in a directory under the user's home directory. The location is operating system specific. Use **Tools > Options > OpenOffice.org > Paths** to view where other configuration data is stored. On Windows XP, this is C:\Documents and Settings\\Application Data. User macros are stored in OpenOffice.org\3\user\basic. Each library is stored in its own directory off the basic directory.

It is not important to understand where macros are stored for casual use. If you know where they are stored, however, you can create a backup, share your macros, or inspect them if there is an error.

Use **Tools > Macros > Organize Dialogs** to open the OpenOffice.org Macro Organizer dialog. Another common way to open this dialog is to use **Tools > Macros > Organize Macros > OpenOffice.org Basic** to open the OpenOffice.org Macros dialog and then click the **Organizer** button.

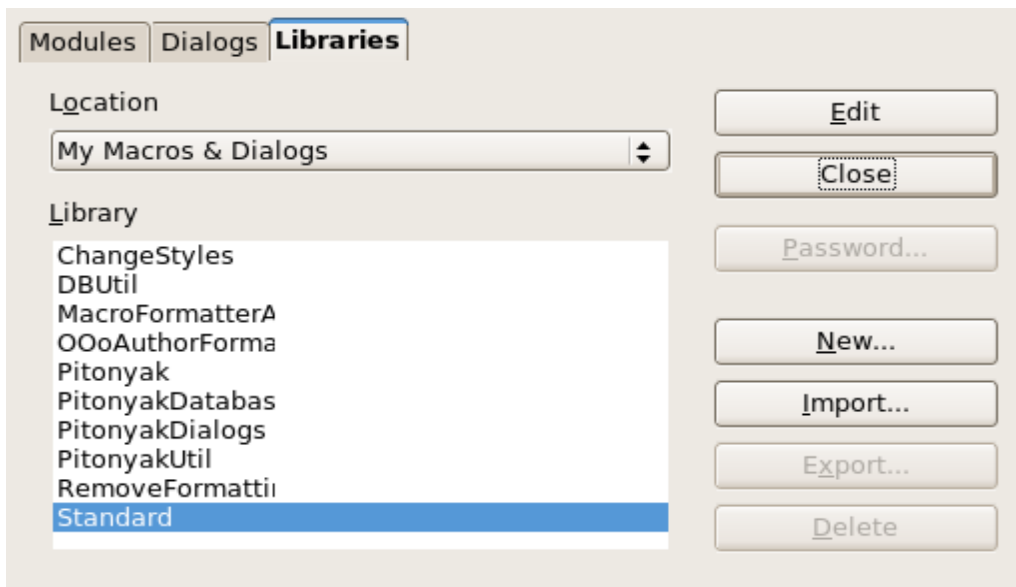

Figure 306: The macro organizer dialog

Importing macros

The OpenOffice.org Macro Organizer dialog provides functionality to create, delete, and rename libraries, modules, and dialogs. Select the library container to use and then click the **Import** button to import macro libraries (see Figure 307).

Tip You cannot import the library named Standard.

Tip On Linux, the OpenOffice.org-specific files are stored in a directory whose name begins with a period. Directories and files with names beginning with a period are not shown in a normal selection dialog. To open the directory, I navigated to the parent directory, entered the name `.openoffice.org\3`, and then clicked **Open**. This opened the directory, which was not initially shown.

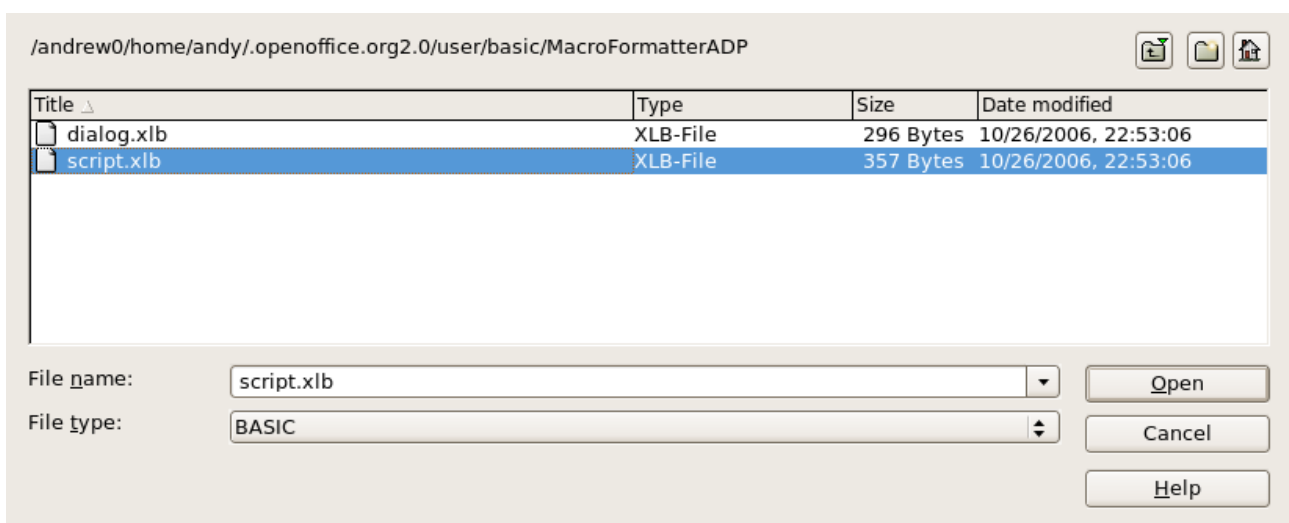

Figure 307: Select a macro library to import

Navigate to the directory containing the library to import. There are usually two files from which to choose, dialog.xlb and script.xlb. It does not matter which of these two files you select; both will be imported. Select a file and click **Open** to continue.

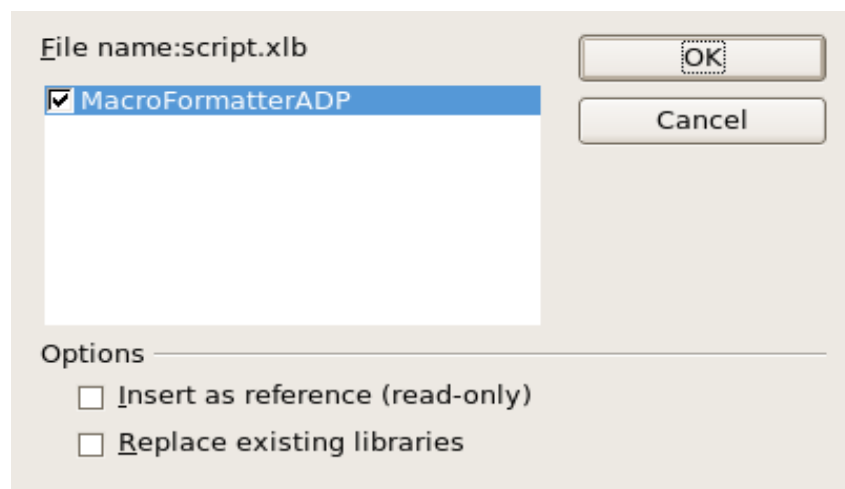

Figure 308: Choose library import options

If the library already exists, it will not be replaced unless **Replace existing libraries** is checked. If **Insert as reference** is checked, the library is referenced in its current location, but you cannot edit the library. If **Insert as reference** is not checked, however, the library is copied to the user’s macro directory.

Macros can be stored in libraries inside OpenOffice.org documents. Select a document rather than a directory on disk (as shown in Figure 307) to import libraries contained in a document.

Downloading macros to import

Macros are available for download. Some macros are contained in documents, some as regular files that you must select and import, and some as macro text that should be copied and pasted into the Basic IDE; use **Tools > Macros > Organize Macros > OpenOffice.org Basic** to open the OpenOffice.org Macros dialog, choose the macro to edit, and then click **Edit** to open the macro in the Basic IDE.

Some macros are available as free downloads on the Internet (see Table 3). “Adding an existing macro” on page 323 describes how to add these macros to your macros library.

Table 3. Places to find macro examples

Location	Description
http://www.oocomacros.org/	Excellent collection of packaged macros.
http://www.pitonyak.org/oo.php	Reference materials regarding macros.
http://www.pitonyak.org/database/	Reference materials regarding database macros.
http://development.openoffice.org/	Lots of links to everything.
http://www.ooforum.org/	Many examples and help.

How to run a macro

A typical method to run a macro is as follows:

- 1) Use **Tools > Macros > Run Macro** to open the Macro Selector dialog (see Figure 309).
- 2) Select the library and module in the Library list (left hand side).
- 3) Select the macro in the Macro name list (right hand side).
- 4) Click **Run** to run the macro.

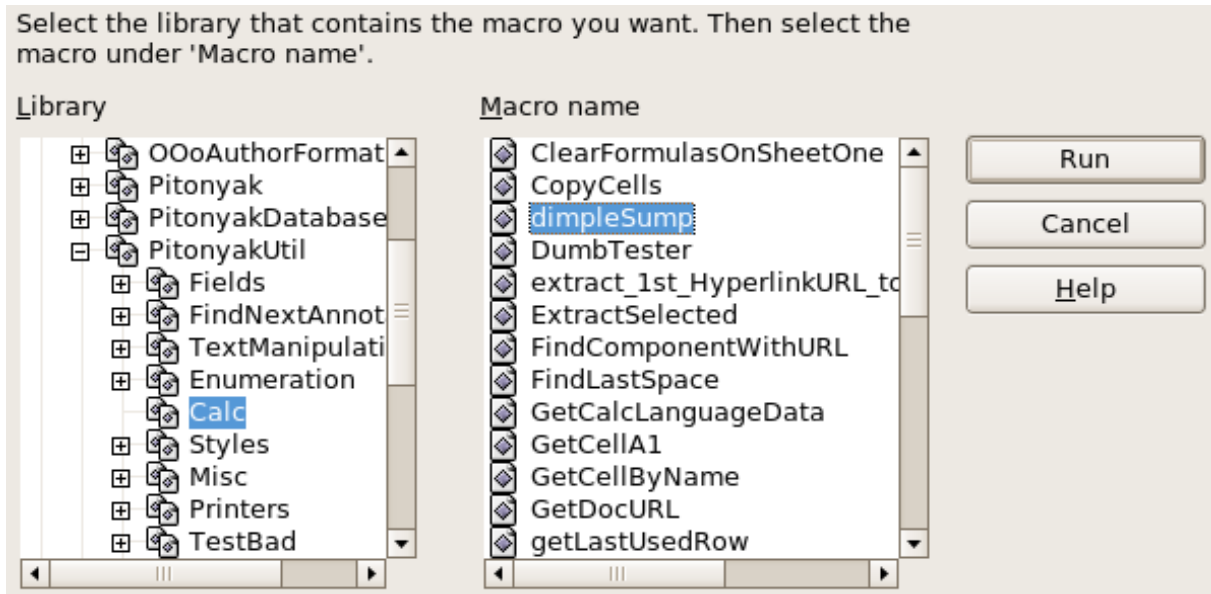

Figure 309: Use the Macro Selector dialog to run macros

Although you can use **Tools > Macros > Run Macro** to run all macros, this is not efficient for frequently run macros. A more common technique is to assign a macro to a toolbar button, menu item, keyboard shortcut, or a button embedded in a document. While choosing a method, it is also good to ask questions such as:

- Should the macro be available for only one document, or globally for all documents?
- Does the macro pertain to a specific document type, such as a Calc document?
- How frequently will the macro be used?

The answers will determine where to store the macro and how to make it available. For example, you will probably not add a rarely used macro to a toolbar. To help determine your choices, see Table 4.

Table 4. Methods for starting a macro

Type	OpenOffice.org	Document Type	Document
Toolbar	No	Yes	Yes
Menu	No	Yes	Yes
Shortcut	Yes	Yes	No
Event	Yes	No	Yes

To add a menu item, keyboard shortcut, or toolbar icon that calls a macro, use the Customize dialog (see Figure 308). Open this dialog in either of these ways:

- Choose **Tools > Customize** from the main menu bar.
- Each toolbar has an icon  that opens a menu; choose the **Customize Toolbar** option.

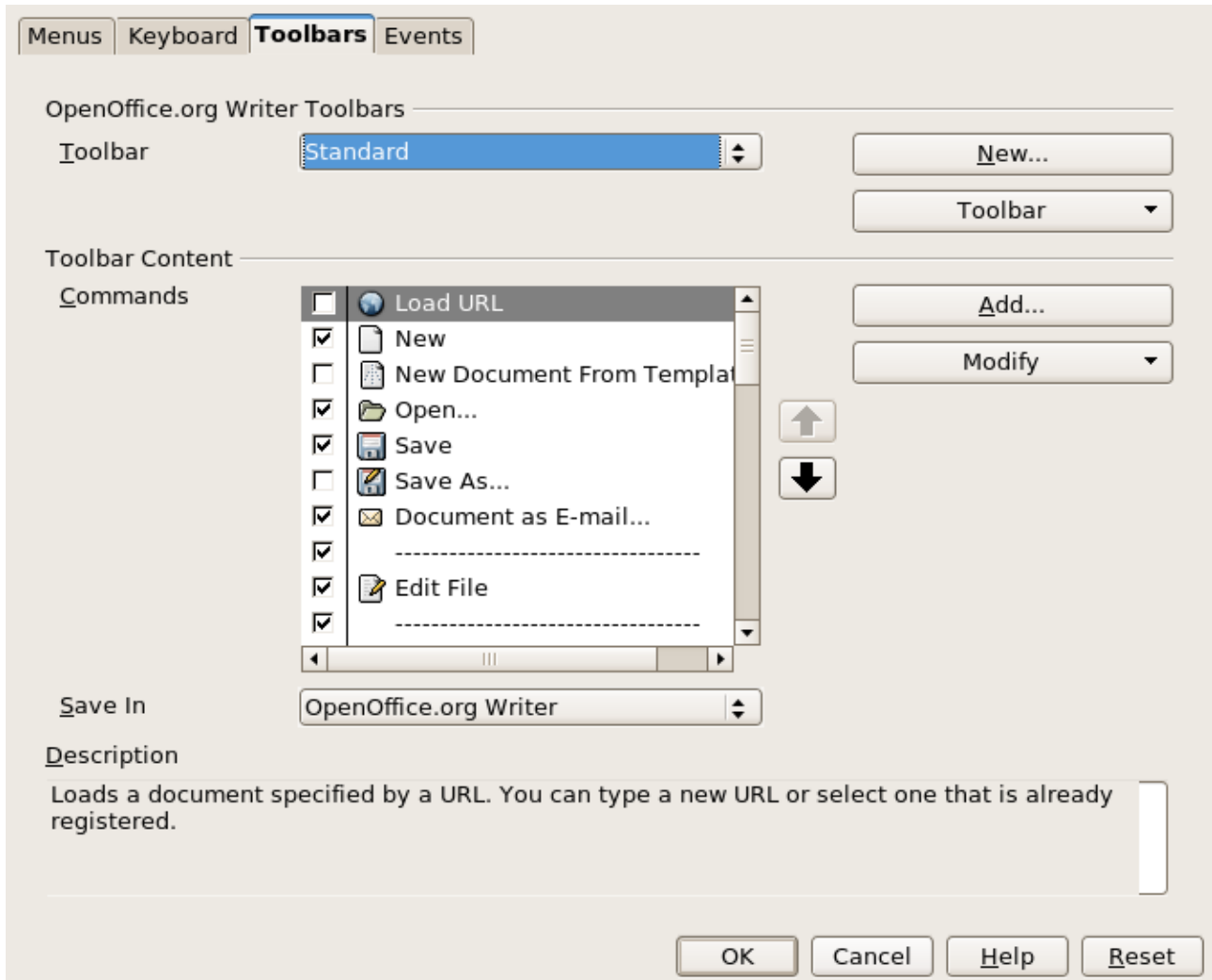

Figure 310: OpenOffice.org Customize dialog

Tip

Complete coverage of the Customize dialog is beyond the scope of this document. Click the **Help** button to access the help pages included with OpenOffice.org.

The Customize dialog contains tabs to configure menus, keyboard bindings, toolbars, and events.

Toolbar

Macros can be added to toolbars. For more about modifying toolbars, see Chapter 14 (Customizing OpenOffice.org).

Menu item

Use **Tools > Customize** to open the Customize dialog, and select the Menus tab. You can modify an existing menu, or create new menus that call macros. For more about modifying menus, see Chapter 14.

Keyboard shortcuts

Use **Tools > Customize** to open the Customize dialog, and select the Keyboard tab. Assigning keyboard shortcuts is discussed in Chapter 14.

Event

In OpenOffice.org, when something happens, we say that an event occurred. For example, a document was opened, a key was pressed, or the mouse moved. OpenOffice.org allows events to cause a macro to be called; the macro is then called an event handler. Full coverage of event handlers is well beyond the scope of this document, but a little knowledge can accomplish much.

Caution



Be careful when you configure an event handler. For example, assume that you write an event handler that is called every time that a key is pressed, but you make a mistake so the event is not properly handled. One possible result is that your event handler will consume all key presses, forcing you to forcibly terminate OpenOffice.org.

Use **Tools > Customize** to open the Customize dialog, and select the Events tab (see Figure 311). The events in the Customize dialog are related to the entire application and specific documents. Use the Save In box to choose OpenOffice.org, or a specific document.

A common use is to assign the Open Document event to call a specific macro. The macro then performs certain setup tasks for the document. Select the desired event and click the **Macro** button to open the Macro Selector dialog (see Figure 312).

Select the desired macro and click **OK** to assign the macro to the event. The Events tab shows that the event has been assigned to a macro (see Figure 313). When the document opens, the PrintHello macro is run.

Many objects in a document can be set to call macros when events occur. The most common usage is to add a control, such as a button, into a document. Even double-clicking on a graphic opens a dialog with a Macros tab that allows you to assign a macro to an event.

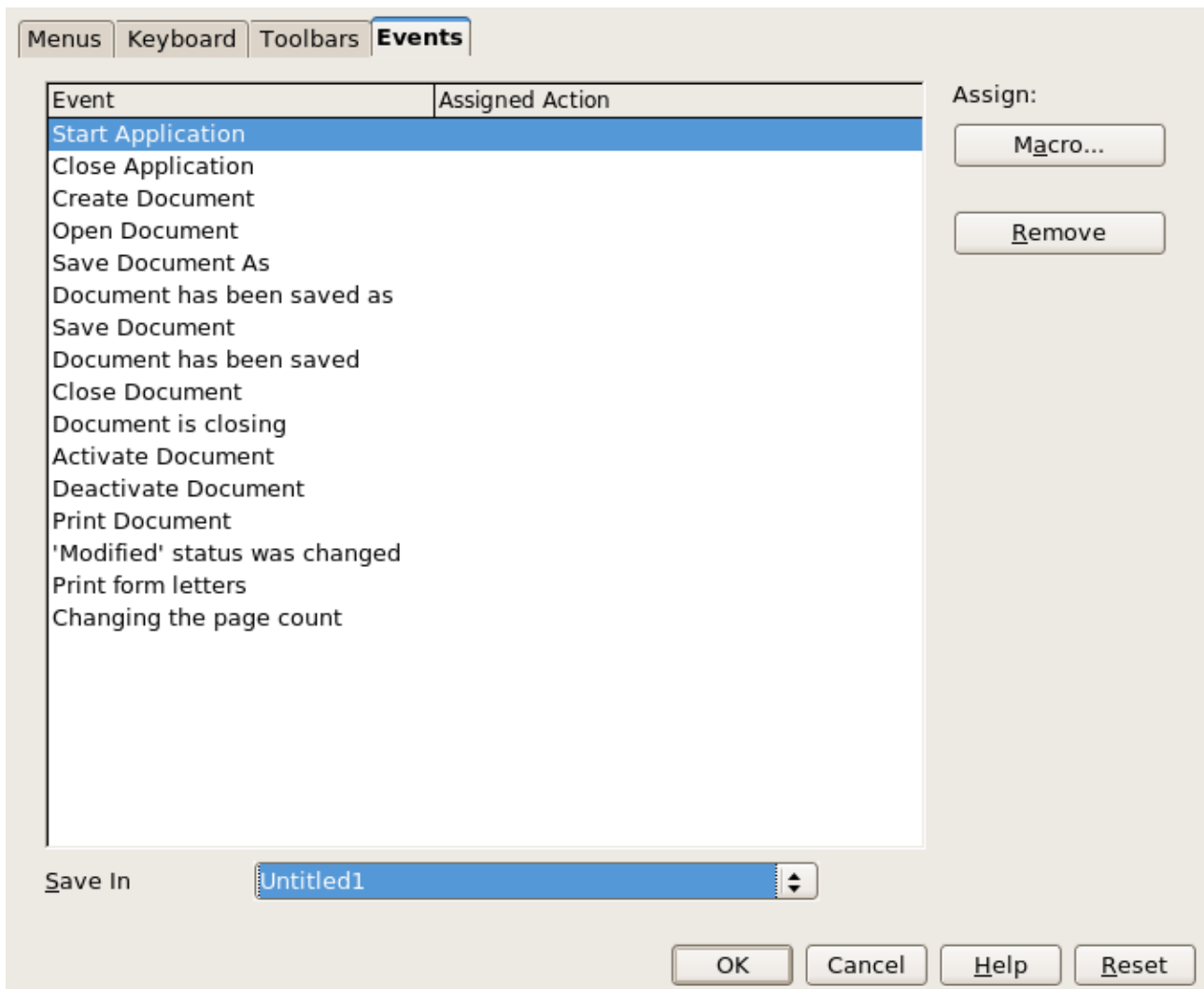

Figure 311: Assign macro to an application level event

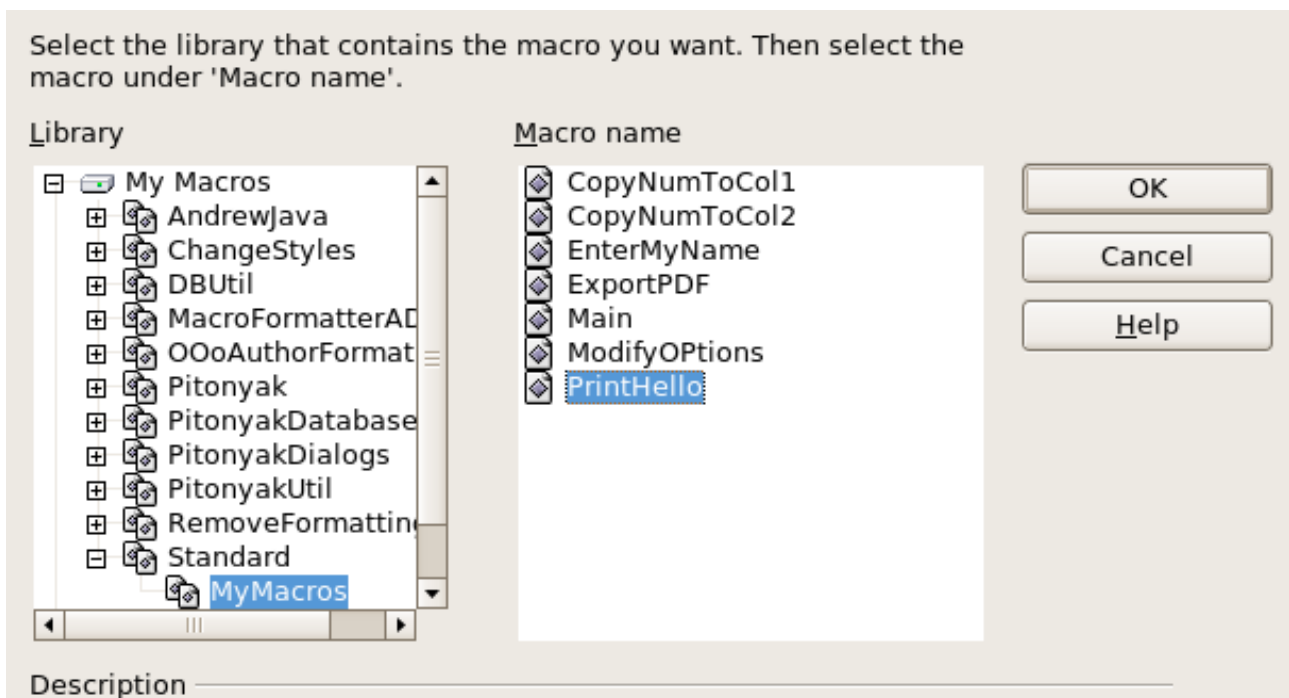

Figure 312: Assign macro to the document open event

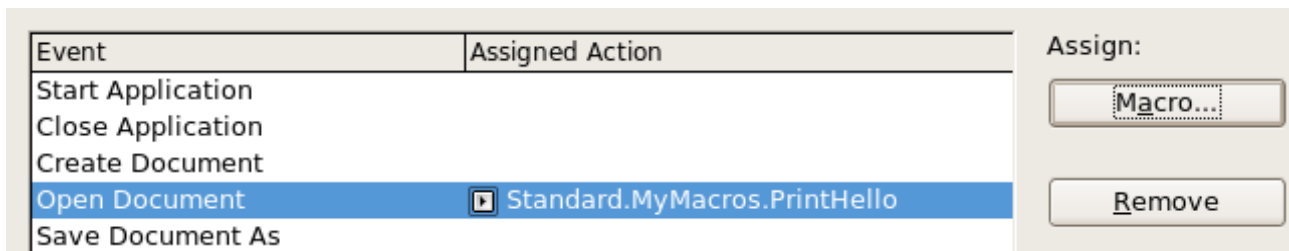

Figure 313: PrintHello is assigned to the Open Document event

Extensions

An extension is a package that can be installed into OpenOffice.org to add new functionality. Extensions can be written in almost any programming language and may be simple or sophisticated. Extensions can be grouped into types:

- Calc Add-Ins, which provide new functionality for Calc, including new functions that act like normal built-in functions
- New components and functionality, which normally include some level of UI integration such as new menus or toolbars
- Data pilots that are used directly in Calc
- Chart Add-Ins with new chart types
- Linguistic components such as spell checkers
- Document templates and images

Although individual extensions can be found in different places, there is an extension repository at: <http://extensions.services.openoffice.org/>.

For more about obtaining and installing extensions, see Chapter 14 (Customizing OpenOffice.org).

Writing macros without the recorder

The examples covered in this chapter are created using the macro recorder and the dispatcher. You can also write macros that directly access the objects that comprise OpenOffice.org. In other words, you can directly manipulate a document.

Directly manipulating OOO's internal objects is an advanced topic that is beyond the scope of this chapter. A simple example, however, demonstrates how this works.

Listing 7: Append the text "Hello" to the current document.

```
Sub AppendHello
  Dim oDoc
  Dim sTextService$
  Dim oCurs

  REM ThisComponent refers to the currently active document.
  oDoc = ThisComponent

  REM Verify that this is a text document
  sTextService = "com.sun.star.text.TextDocument"
  If NOT oDoc.supportsService(sTextService) Then
```

```

    MsgBox "This macro only works with a text document"
    Exit Sub
End If

REM Get the view cursor from the current controller.
oCurs = oDoc.currentController.getViewCursor()

REM Move the cursor to the end of the document
oCurs.gotoEnd(False)

REM Insert text "Hello" at the end of the document
oCurs.Text.insertString(oCurs, "Hello", False)
End Sub

```

Finding more information

Numerous resources are available that provide help with writing macros. Use **Help > OpenOffice.org Help** to open the OOO help pages. The upper left corner of the OOO help system contains a drop-down list that determines which help set is displayed. To view the help for Basic, choose *OpenOffice.org Basic* from this list.

Included material

Many excellent macros are included with OOO. Use **Tools > Macros > Organize Macros > OpenOffice.org Basic** to open the Macro dialog. Expand the Tools library in the OpenOffice.org library container. Inspect the Debug module—some good examples include `WritedbInfo(document)` and `printdbgInfo(sheet)`.

Online resources

The following links and references contain information regarding macro programming:

<http://user.services.openoffice.org/> (OOO forums, well supported)

<http://api.openoffice.org/docs/common/ref/com/sun/star/module-ix.html> (official IDL reference; here you'll find almost every command with a description)

http://wiki.services.openoffice.org/wiki/Documentation/BASIC_Guide (official OpenOffice.org BASIC Programming Guide)

http://wiki.services.openoffice.org/wiki/Documentation/DevGuide/OpenOffice.org_Developers_Guide (official OpenOffice.org Developers Guide; contains a detailed explanation)

<http://www.pitonyak.org/oo.php> (Andrew Pitonyak's macro page)

<http://www.pitonyak.org/AndrewMacro.odt> (numerous examples of working macros)

<http://www.pitonyak.org/book/> (Andrew Pitonyak's book on macros)

<http://www.pitonyak.org/database/> (numerous macro examples using Base)

<http://docs.sun.com/app/docs/doc/819-0439> (Sun's book on macro programming—very well written and laid out; the OOO BASIC Programming Guide and the OOO Developers Guide are derived from this book)

Printed and eBook materials

The following books are available for purchase in both printed and eBook form from their publishers.

Andrew Pitonyak's *OpenOffice.org Macros Explained*. See <http://www.hentzenwerke.com/catalog/oome.htm>.

Dr. Mark Alexander Bain's *Learn OpenOffice.org Spreadsheet Macro Programming*. See <http://www.packtpub.com/openoffice-ooobasic-calc-automation/book>.

Chapter 14
Customizing
OpenOffice.org

Introduction

This Appendix describes some common customizations that you may wish to do.

You can customize menus, toolbars, and keyboard shortcuts in OpenOffice.org, add new menus and toolbars, and assign macros to events. However, you cannot customize context (right-click) menus.

Other customizations are made easy by extensions that you can install from the OpenOffice.org website or from other providers.

Note Customizations to menus and toolbars can be saved in a template. To do so, first save them in a document and then save the document as a template as described in Chapter 3 (Styles and Templates).

Customizing menu content

In addition to changing the menu font (described in Chapter 2), you can add and rearrange items on the menu bar, add items to menus, and make other changes.

To customize menus:

- 1) Choose **Tools > Customize**.
- 2) On the **Customize** dialog, pick the **Menus** page.

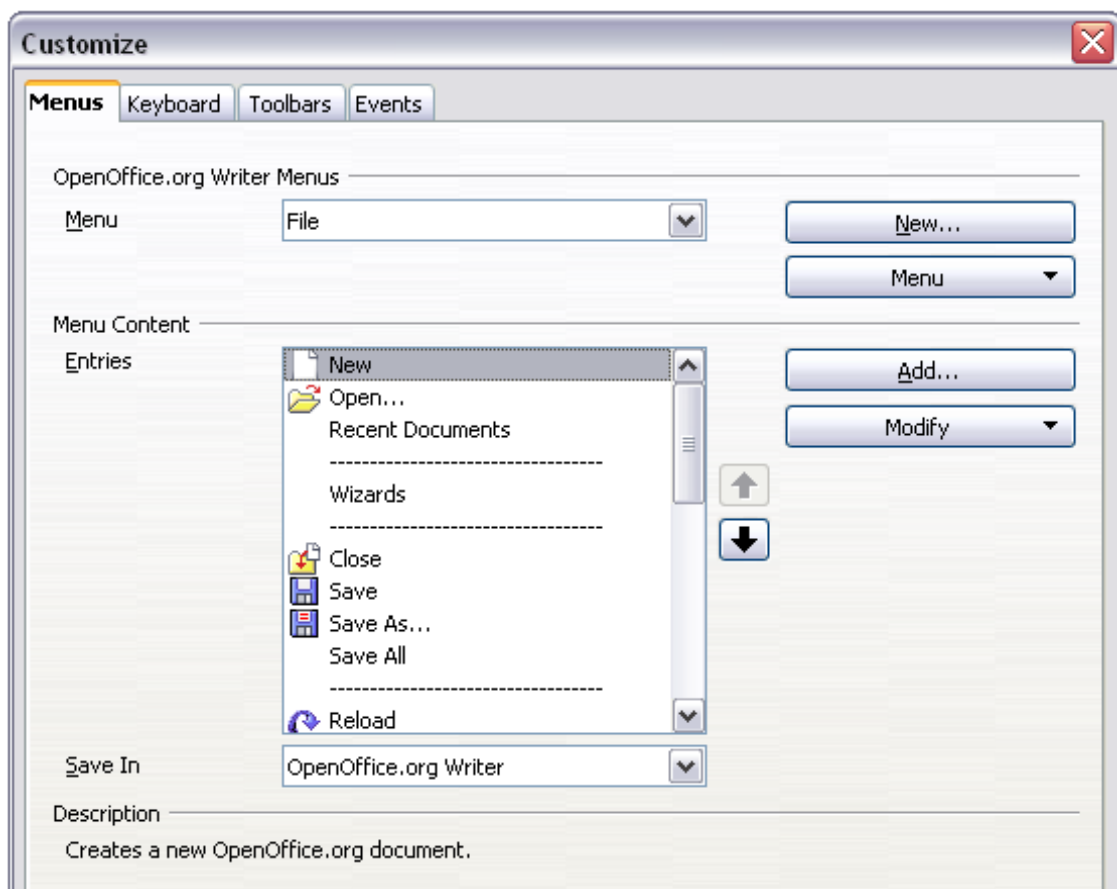

Figure 314. The Menus page of the Customize dialog

- 3) In the Save In drop-down list, choose whether to save this changed menu for the application (for example, OpenOffice.org Writer) or for a selected document (for example, MyDoc.odt).
- 4) In the section **OpenOffice.org [name of the program (example: Writer)] Menus**, select from the **Menu** drop-down list the menu that you want to customize. The list includes all the main menus as well as submenus (menus that are contained under another menu). For example, in addition to *File*, *Edit*, *View*, and so on, there is *File | Send* and *File | Templates*. The commands available for the selected menu are shown in the central part of the dialog.
- 5) To customize the selected menu, click on the **Menu** or **Modify** buttons. You can also add commands to a menu by clicking on the **Add** button. These actions are described in the following sections. Use the up and down arrows next to the Entries list to move the selected menu item to a different position.
- 6) When you have finished making all your changes, click **OK** (not shown in illustration) to save them.

Creating a new menu

In the Customize dialog, click **New** to display the dialog shown in Figure 315.

- 1) Type a name for your new menu in the **Menu name** box.
- 2) Use the up and down arrow buttons to move the new menu into the required position on the menu bar.
- 3) Click **OK** to save.

The new menu now appears on the list of menus in the Customize dialog. (It will appear on the menu bar itself after you save your customizations.)

After creating a new menu, you need to add some commands to it, as described in “Adding a command to a menu” on page 348.

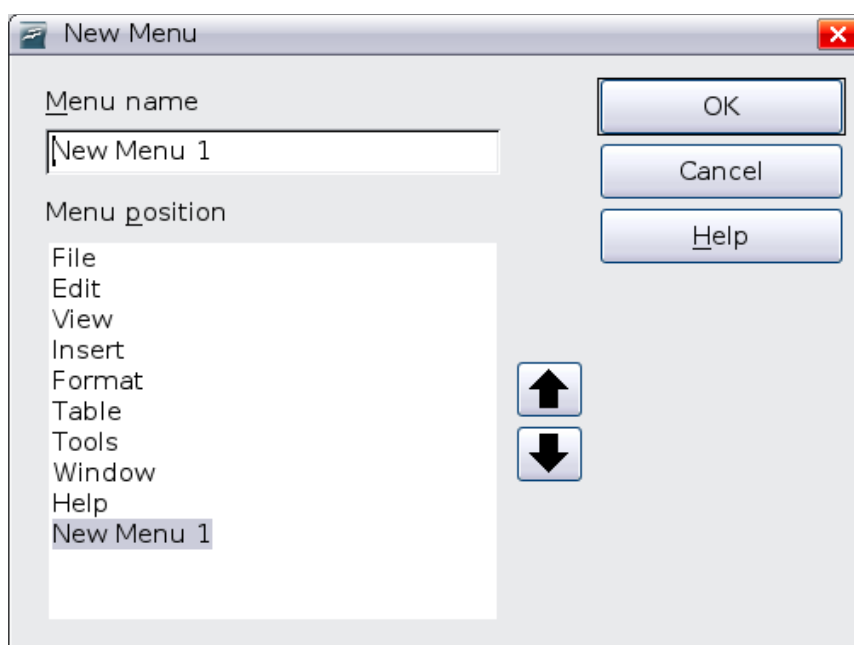

Figure 315: Adding a new menu

Modifying existing menus

To modify an existing menu, select it in the Menu list and click the **Menu** button to drop down a list of modifications: **Move**, **Rename**, **Delete**. Not all of these modifications can be applied to all the entries in the Menu list. For example, **Rename** and **Delete** are not available for the menus supplied by OOo.

To move a menu (such as *File*), choose **Menu > Move**. A dialog similar to the one shown in Figure 315 (but without the **Menu name** box) opens. Use the up and down arrow buttons to move the menu into the required position.

To move submenus (such as *File | Send*), select the main menu (File) in the Menu list and then, in the Menu Content section of the dialog, select the submenu (Send) in the Entries list and use the arrow keys to move it up or down in the sequence.

In addition to renaming, you can specify a keyboard shortcut that allows you to select a menu command when you press *Alt+* an underlined letter in a menu command.

- 1) Select a menu entry.
- 2) Click the **Modify** button and select **Rename**.
- 3) Add a tilde (~) in front of the letter that you want to use as an accelerator. For example, to select the Save All command by pressing *Alt+V* (after opening the File menu using *Alt+F*), enter *Sa~ve All*.

Caution



Be careful when using these shortcuts. In the example above, if the File menu is not already open, then pressing *Alt+V* opens the View menu; if some other menu is open, *Alt+V* might activate some other command.

Adding a command to a menu

You can add commands to the supplied menus and to menus you have created. On the Customize dialog, select the menu in the Menu list and click the **Add** button in the Menu Content section of the dialog.

On the Add Commands dialog (Figure 316), select a category and then the command, and click **Add**. The dialog remains open, so you can select several commands. When you have finished adding commands, click **Close**. Back on the Customize dialog, you can use the up and down arrow buttons to arrange the commands in your preferred sequence.

Modifying menu entries

In addition to changing the sequence of entries on a menu or submenu, you can add submenus, rename or delete the entries, and add group separators.

To begin, select the menu or submenu in the Menu list near the top of the Customize page, then select the entry in the Entries list under Menu Content. Click the **Modify** button and choose the required action from the drop-down list of actions.

Most of the actions should be self-explanatory. **Begin a group** adds a separator line after the highlighted entry.

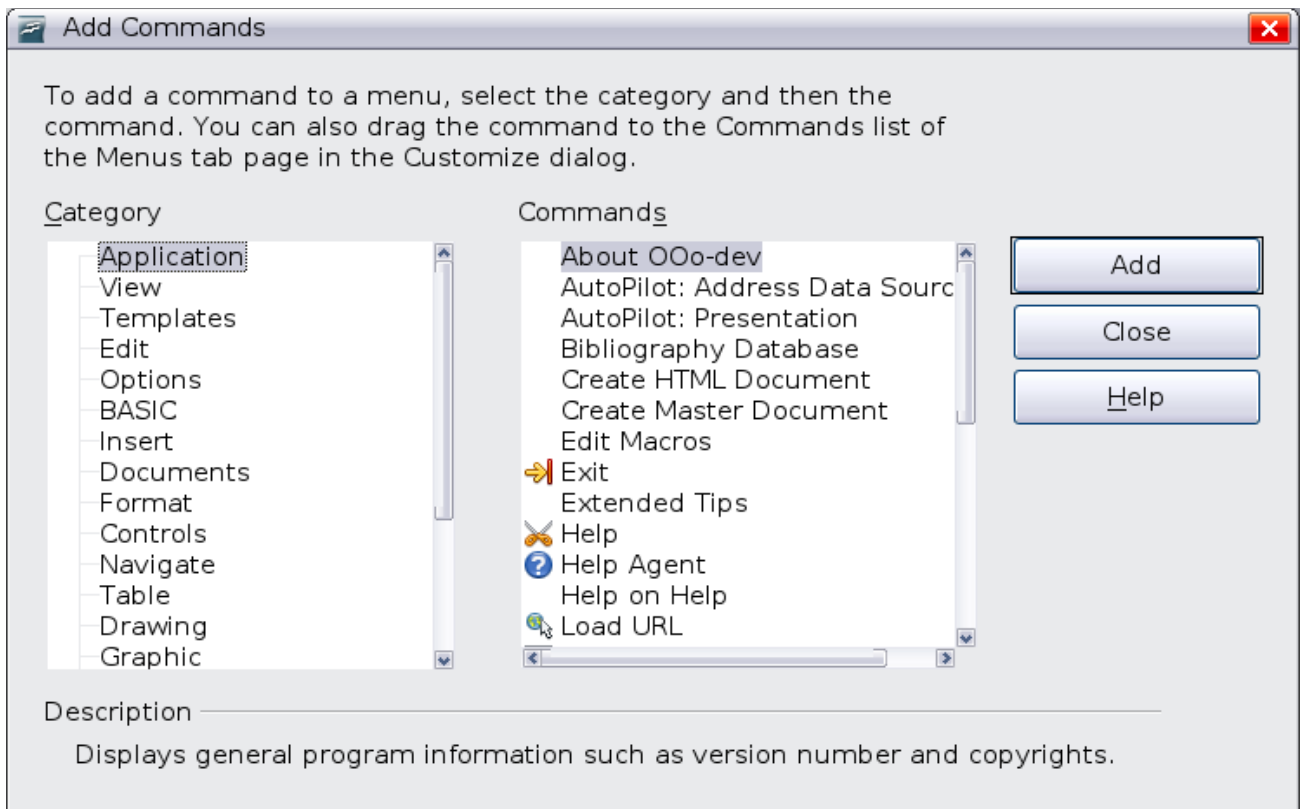

Figure 316: Adding a command to a menu

Customizing toolbars

You can customize toolbars in several ways, including choosing which icons are visible and locking the position of a docked toolbar, as described in Chapter 1 (Introducing OpenOffice.org). This section describes how to create new toolbars and add other icons (commands) to the list of those available on a toolbar.

To get to the toolbar customization dialog, do any of the following:

- On the toolbar, click the arrow at the end of the toolbar and choose **Customize Toolbar**.
- Choose **View > Toolbars > Customize** from the menu bar.
- Choose **Tools > Customize** from the menu bar and pick the **Toolbars** page (Figure 317).

To customize toolbars:

- 1) In the Save In drop-down list, choose whether to save this changed toolbar for the application (for example, Writer) or for a selected document.
- 2) In the section **OpenOffice.org <name of the program (example: Writer)> Toolbars**, select from the **Toolbar** drop-down list the toolbar that you want to customize.
- 3) You can create a new toolbar by clicking on the **New** button, or customize existing toolbars by clicking on the **Toolbar** or **Modify** buttons, and add commands to a toolbar by clicking on the **Add** button. These actions are described below.
- 4) When you have finished making all your changes, click **OK** to save them.

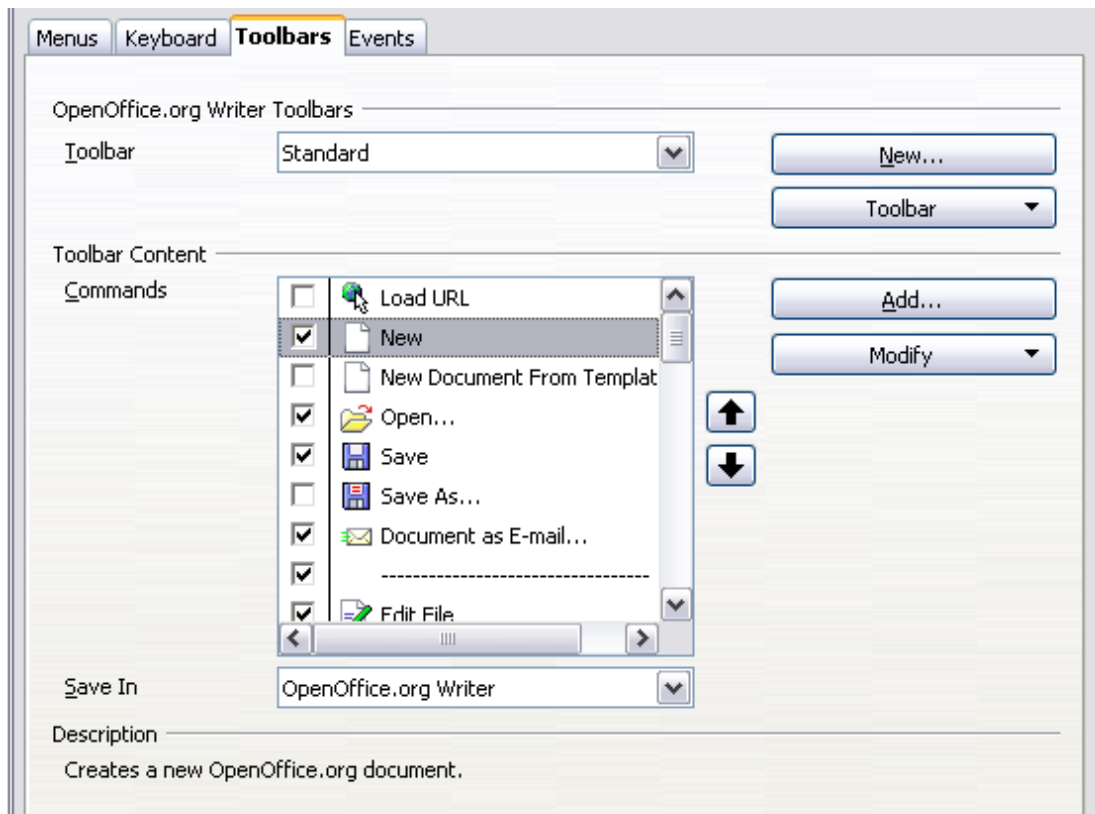
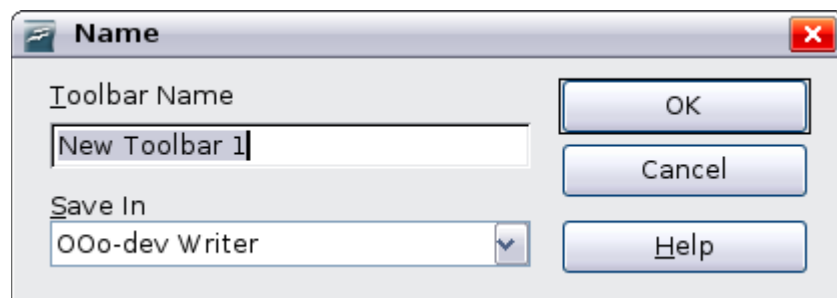

Figure 317. The Toolbars page of the Customize dialog

Creating a new toolbar

To create a new toolbar:

- 1) Choose **Tools > Customize > Toolbars** from the menu bar.
- 2) Click **New**. On the Name dialog, type the new toolbar's name and choose from the Save In drop-down list where to save this changed menu: for the application (for example, Writer) or for a selected document.



The new toolbar now appears on the list of toolbars in the Customize dialog. After creating a new toolbar, you need to add some commands to it, as described below.

Adding a command to a toolbar

If the list of available buttons for a toolbar does not include all the commands you want on that toolbar, you can add commands. When you create a new toolbar, you need to add commands to it.

- 1) On the Toolbars page of the Customize dialog, select the toolbar in the Toolbar list and click the **Add** button in the Toolbar Content section of the dialog.

- 2) The Add Commands dialog is the same as for adding commands to menus (Figure 316). Select a category and then the command, and click **Add**. The dialog remains open, so you can select several commands. When you have finished adding commands, click **Close**. If you insert an item which does not have an associated icon, the toolbar will display the full name of the item: the next section describes how to choose an icon for a toolbar command.
- 3) Back on the Customize dialog, you can use the up and down arrow buttons to arrange the commands in your preferred sequence.
- 4) When you are done making changes, click **OK** to save.

Choosing icons for toolbar commands

Toolbar buttons usually have icons, not words, on them, but not all of the commands have associated icons.

To choose an icon for a command, select the command and click **Modify > Change icon**. On the Change Icon dialog, you can scroll through the available icons, select one, and click **OK** to assign it to the command.

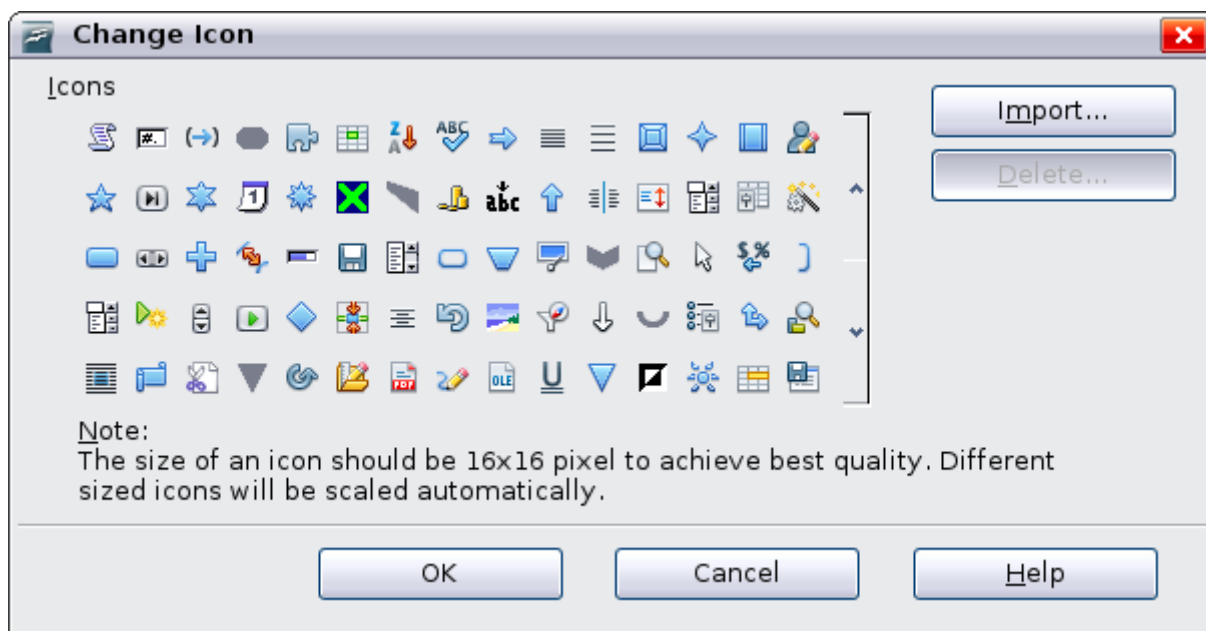

Figure 318: Change Icon dialog

To use a custom icon, create it in a graphics program and import it into OOo by clicking the **Import** button on the Change Icon dialog. Custom icons must be 16 x 16 or 26 x 26 pixels in size and cannot contain more than 256 colors.

Example: Adding a Fax icon to a toolbar

You can customize OpenOffice.org so that a single click on an icon automatically sends the current document as a fax.

- 1) Be sure the fax driver is installed. Consult the documentation for your fax modem for more information.
- 2) Choose **Tools > Options > OpenOffice.org Writer > Print**. The dialog shown in Figure 319 opens.
- 3) Select the fax driver from the **Fax** list and click **OK**.

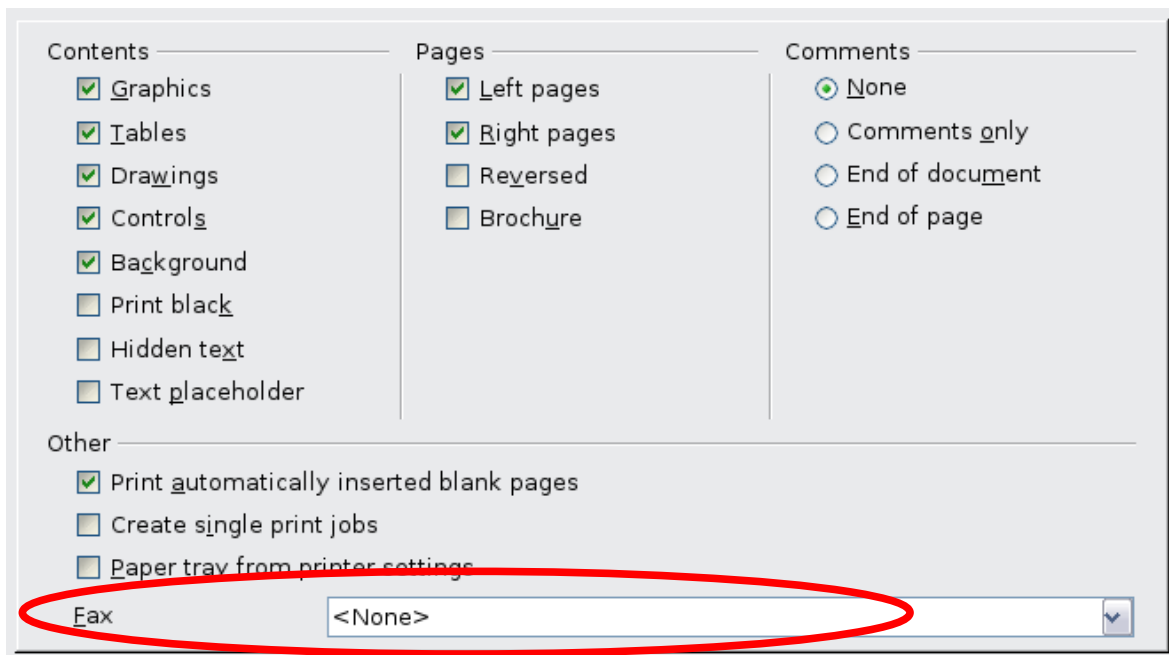

Figure 319: Setting up OoO for sending faxes

- 4) Click the arrow icon at the end of the Standard toolbar. In the drop-down menu, choose **Customize Toolbar**. The Toolbars page of the Customize dialog appears (Figure 317). Click **Add**.
- 5) On the Add Commands dialog (Figure 320), select *Documents* in the Category list, then select *Send Default Fax* in the Commands list. Click **Add**. Now you can see the new icon in the Commands list.
- 6) In the Commands list, click the up or down arrow button to position the new icon where you want it. Click **OK** and then click **Close**.

Your toolbar now has a new icon to send the current document as a fax.

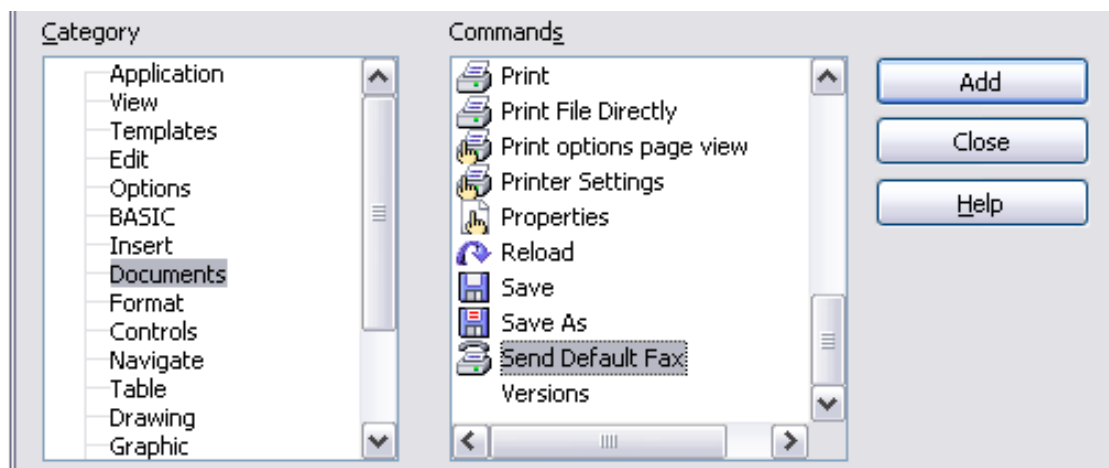

Figure 320: Adding a Send Fax command to a toolbar

Assigning shortcut keys

In addition to using the built-in keyboard shortcuts (listed in Appendix A), you can define your own. You can assign shortcuts to standard OOO functions or your own macros and save them for use with the entire OpenOffice.org suite.

Caution



Be careful when reassigning your operating system's or OOO's predefined shortcut keys. Many key assignments are universally understood shortcuts, such as *F1* for Help, and are always expected to provide certain results. Although you can easily reset the shortcut key assignments to the OOO defaults, changing some common shortcut keys can cause confusion, frustration and possible data loss or corruption, especially if other users share your computer.

To adapt shortcut keys to your needs, use the Customize dialog, as described below.

- 1) Select **Tools > Customize > Keyboard**. The Customize dialog opens.
- 2) To have the shortcut key assignment available in all components of OpenOffice.org select the **OpenOffice.org** button.
- 3) Next select the required function from the *Category* and *Function* lists.
- 4) Now select the desired shortcut keys in the *Shortcut keys* list and click the **Modify** button at the upper right.
- 5) Click **OK** to accept the change. Now the chosen shortcut keys will execute the function chosen in step 3 above whenever they are pressed.

Note

All existing shortcut keys for the currently selected *Function* are listed in the *Keys* selection box. If the *Keys* list is empty, it indicates that the chosen key combination is free for use. If it were not, and you wanted to reassign a shortcut key combination that is already in use, you must first delete the existing key.

Shortcut keys that are greyed-out in the listing on the Customize dialog, such as *F1* and *F10*, are not available for reassignment.

Example: Assigning styles to shortcut keys

You can configure shortcut keys to quickly assign styles in your document. Some shortcuts are predefined, such as *Ctrl+0* for the *Text body* paragraph style, *Ctrl+1* for the *Heading 1* style, and *Ctrl+2* for *Heading 2*. You can modify these shortcuts and create your own.

- 1) Click **Tools > Customize > Keyboard**. The Keyboard page of the Customize dialog (Figure 321) opens.
- 2) To have the shortcut key assignment available only with one component (for example, Writer), select that component's name in the upper right corner of the page; otherwise select **OpenOffice.org** button to make it available to every component.
- 3) Choose the shortcut keys you want to assign a style to. In this example, we have chosen *Ctrl+9*.
- 4) In the *Functions* section at the bottom of the dialog, scroll down in the *Category* list to *Styles*. Click the expansion symbol (usually a + sign or triangle) to expand the list of styles.

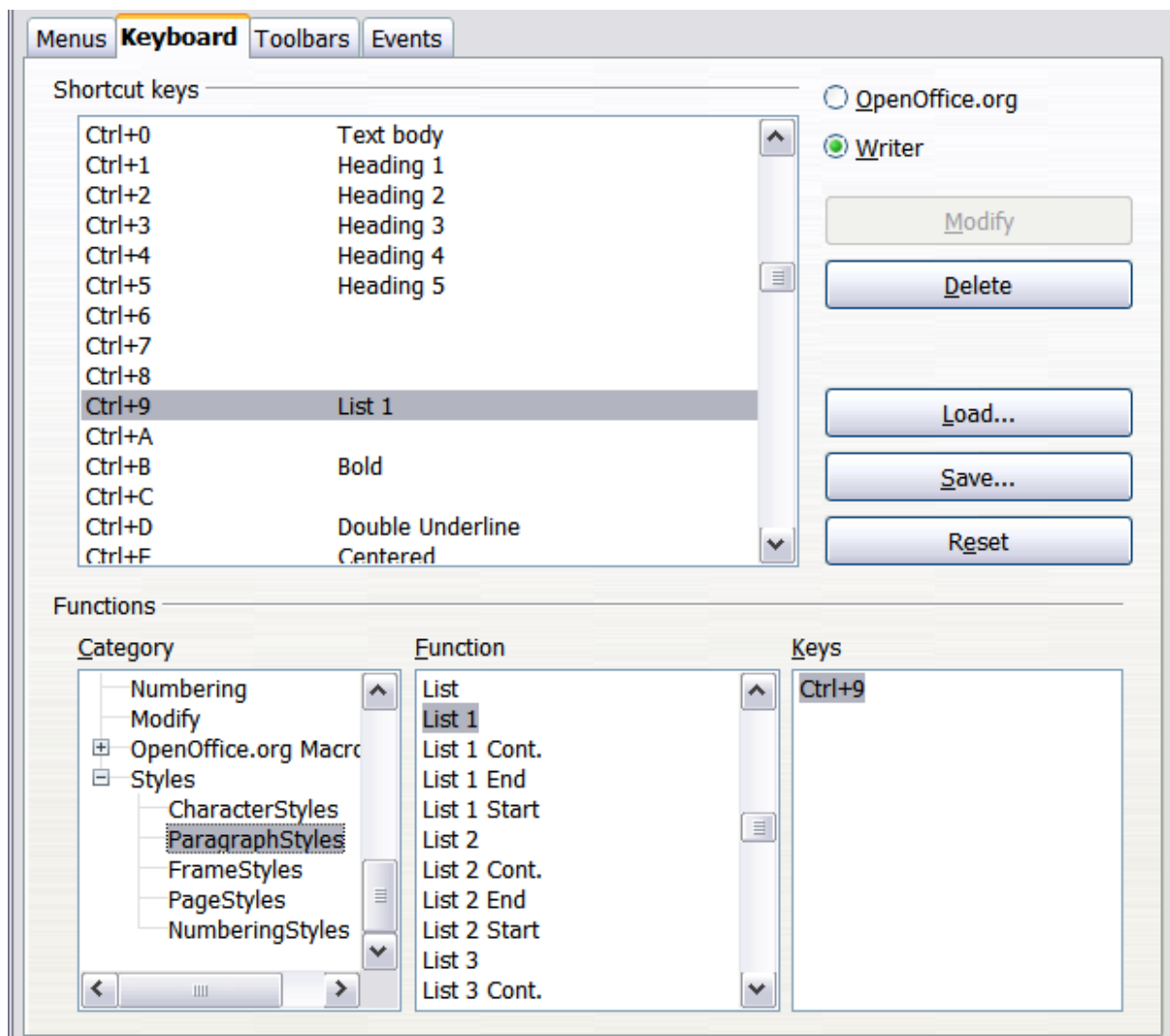

Figure 321. Defining keyboard shortcuts for applying styles

- 5) Choose the category of style. (This example uses a paragraph style, but you can also choose character styles and others.) The *Function* list will display the names of the available styles for the selected category. The example shows some of Oo's predefined styles.
- 6) To assign *Ctrl+9* to be the shortcut key combination for the *List 1* style, select *List 1* in the *Function* list, and then click **Modify**. *Ctrl+9* now appears in the *Keys* list on the right, and *List 1* appears next to *Ctrl+9* in the *Shortcut keys* box at the top.
- 7) Make any other required changes, and then click **OK** to save these settings and close the dialog.

Saving changes to a file

Changes to the shortcut key assignments can be saved in a keyboard configuration file for use at a later time, thus permitting you to create and apply different configurations as the need arises. To save keyboard shortcuts to a file:

- 1) After making your keyboard shortcut assignments, click the **Save** button at the right of the *Customize* dialog (Figure 321).
- 2) In the *Save Keyboard Configuration* dialog, select *All files* from the **Save as Type** list.

- 3) Next enter a name for the keyboard configuration file in the **File name** box, or select an existing file from the list. If you need to, browse to find a file from another location.
- 4) Click **Save**. A confirmation dialog appears if you are about to overwrite an existing file, otherwise there will be no feedback and the file will be saved.

Loading a saved keyboard configuration

To load a saved keyboard configuration file and replace your existing configuration, click the **Load** button at the right of the Customize dialog, and then select the configuration file from the Load Keyboard Configuration dialog.

Resetting the shortcut keys

To reset all of the keyboard shortcuts to their default values, click the **Reset** button near the bottom right of the Customize dialog. Use this feature with care as no confirmation dialog will be displayed; the defaults will be set without any further notice or user input.

Assigning macros to events

In OOo, when something happens, we say that an event occurred. For example, a document was opened, a key was pressed, or the mouse moved. You can associate a macro with an event, so the macro is run when the event occurs. For example, a common use is to assign the “open document” event to run a macro that performs certain setup tasks for the document.

To associate a macro with an event, use the Events page of the Customize dialog. For more information, see Chapter 13 (Getting Started with Macros).

Adding functionality with extensions

An extension is a package that can be installed into OpenOffice.org to add new functionality.

Although individual extensions can be found in different places, the official extension repository is at <http://extensions.services.openoffice.org/>. Some extensions are free of charge; others are available for a fee. Check the descriptions to see what licenses and fees apply to the ones that interest you.

Installing extensions

To install an extension, follow these steps:

- 1) Download an extension and save it anywhere on your computer.
- 2) In OOo, select **Tools > Extension Manager** from the menu bar. In the Extension Manager dialog (Figure 322), click **Add**.
- 3) A file browser window opens. Find and select the extension you want to install and click **Open**. The extension begins installing. You may be asked to accept a license agreement.
- 4) When the installation is complete, the extension is listed in the Extension Manager dialog.

Tip To get extensions that are listed in the repository, you can open the Extension Manager and click the **Get more extensions here** link.

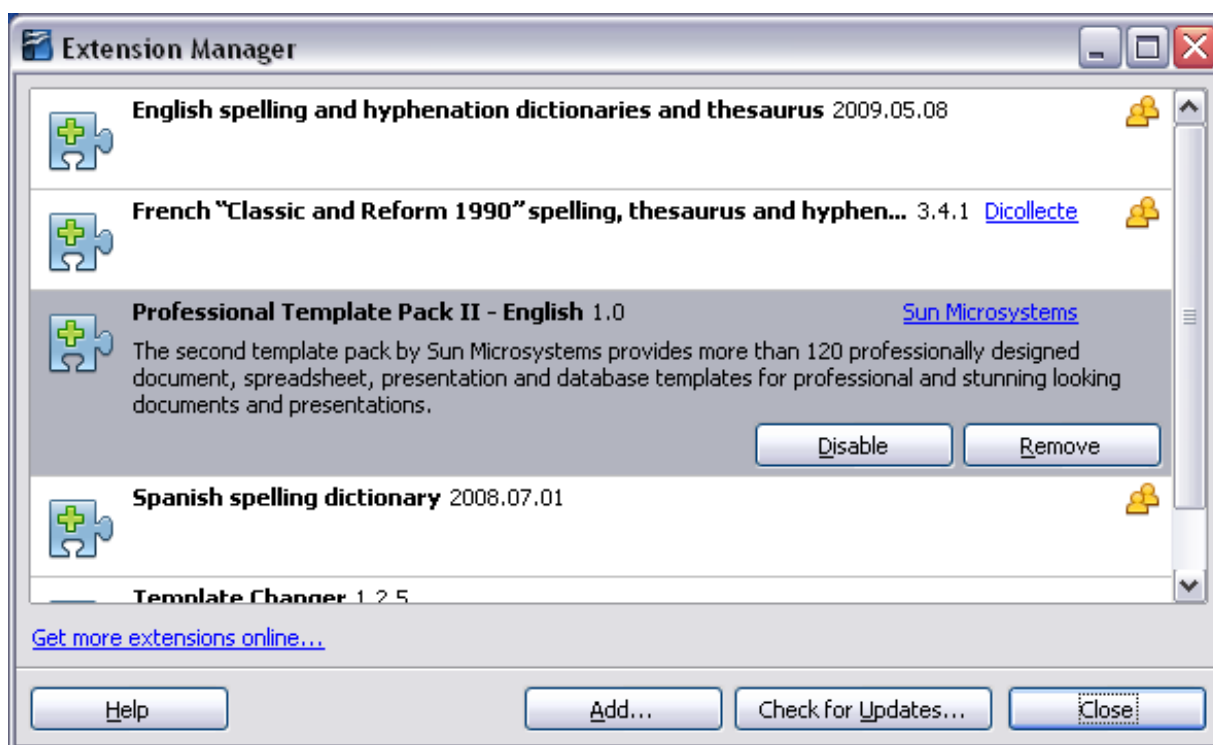

Figure 322: Using the Extension Manager

Note To install a *shared* extension, you need write access to the OpenOffice.org installation directory.

Some popular extensions

This section describes a few of the more important and popular extensions to OpenOffice.org. In each case, you need to first install the extension as described in the previous section. All tools listed here are open source and free of charge.

PDF Import

Enables you to make minor modifications to the text of existing PDF files when the original source files do not exist or you are unable to open the source files. (Whenever possible, modify the source and regenerate the PDF to obtain the best results.)

When the extension is installed, PDF is listed as a choice in the File Type drop-down list in the **File > Open** dialog.

Best results can be achieved with the *PDF/ODF hybrid file* format, which this extension also enables. A hybrid PDF/ODF file is a PDF file that contains an embedded ODF source file. Hybrid PDF/ODF files will be opened in OpenOffice.org as an ODF file without any layout changes.

Non-hybrid PDF documents open in Draw. Depending on the complexity of the layout, changes may be easy or difficult to make, and the saved result may or may not preserve the original layout. Font substitution may occur.

Documents with more sophisticated layouts, such as those created with professional desktop publishing applications that use special fonts and complex vector graphics, are not suitable for the PDF Import Extension. Similarly, longer documents (> 20 pages) may cause some performance and stability problems.

Presenter Console

Provides extra control over slide shows (presentations); for example, the presenter has ability to see the upcoming slide, the slide notes, and a presentation timer—while the audience sees only the current slide. The Presenter Console displays the elements in three easily changeable views:

- The first view displays the current slide, including the effects, and the upcoming slide.
- The second view shows the speaker's notes in large, clear, and scalable type, plus the current and upcoming slide.
- The third view is a slide sorter view with the slide thumbnails.

Note

The Presenter Console works only on an operating system that supports multiple displays.

Report Builder

Creates stylish, complex database reports from Base. You can define group and page headers, group and page footers, and calculation fields. Export your reports into PDF or OpenDocument formats, or send them as email attachments.

Professional Template Pack II

Provides more than 120 templates for Writer, Calc, and Impress. Available in several languages. After you have installed this extension, you will find the templates under **File > New > Templates and Documents**.

Template Changer (for Writer)

Adds two new items to the **File > Templates** menu in Writer that allow you to assign a new template to the current document or to a folder of documents. All styles and formatting will be loaded from that template and the document will behave as it was created using that template.

Solver for Nonlinear Programming (for Calc)

Calc ships with a solver engine for linear programming only. This extension adds more solvers, which are capable of handling nonlinear problems as well as linear ones:

- DEPS - Differential Evolution & Particle Swarm Optimization
- SCO - Social Cognitive Optimization

DataPilot Tools for Calc

Adds some utility functions that make using the Calc DataPilot easier:

- Display the current source range for a DataPilot
- Change the source range for a DataPilot
- Refresh all DataPilots on the current sheet

Appendix A

Keyboard Shortcuts

Introduction

You can use OpenOffice.org (OOo) without requiring a pointing device, such as a mouse or trackball, by using its built-in keyboard shortcuts.

This appendix lists some of the most common built-in keyboard shortcuts that apply to all components of OpenOffice.org. For shortcuts specific to Writer, Calc, Impress, Draw, or Base read the relevant component guide or search the application Help.

Note Some of the shortcuts listed here may not work if your operating system uses the same shortcuts for other tasks. To get around this problem, assign different keys to these shortcuts by reconfiguring either OOo (see Chapter 14) or your operating system (see system documentation).

Tip for Macintosh users

Some keystrokes are different on a Mac from those used in Windows and Linux. The following table gives some common substitutions for the instructions in this book. For a more detailed list, see the application Help.

Windows/Linux	Mac equivalent	Effect
Right-click	Control+click	Open context menu
Ctrl (Control)	⌘ (<i>Command</i>)	Used with other keys
F5	Shift+⌘+F5	Open the Navigator
F11	⌘+T	Open Styles & Formatting window

General keyboard shortcuts

Opening menus and menu items

Shortcut Keys	Result
Alt+<?>	Opens a menu where <?> is the underlined character of the menu you want to open. For example, <i>Alt+T</i> opens the menu <u>T</u> ools.
Alt+<?>+<*>	Opens a menu item where <?> is the underlined character of the menu you want to open and <*> is the item within that menu. For example, <i>Alt+T+G</i> opens the <u>G</u> allery menu item in the menu <u>T</u> ools.
Esc	Closes an open menu.

Controlling dialogs

When you open any dialog, one element (such as a button, an option field, an entry in a list box, or a checkbox) is highlighted or indicated by a dotted box around the field or button name. This element is said to have the focus on it.

Shortcut Keys	Result
Enter	Activates selected button. In most cases where no button is selected, <i>Enter</i> is equivalent to clicking OK .
Esc	Closes dialog without saving any changes made while it was open. In most cases, <i>Esc</i> is equivalent to clicking Cancel. When an open drop-down list is selected, <i>Esc</i> closes the list.
Spacebar	Checks an empty checkbox. Clears a checked checkbox.
Up, down arrow keys	Moves focus up and down a list. Increases or decreases value of a variable. Moves focus vertically within a section of dialog.
Right, left arrow keys	Moves focus horizontally within a section of a dialog.
Tab	Advances focus to the next section or element of a dialog.
Shift+Tab	Returns focus to the previous section or element in a dialog.
Alt+Down Arrow	Shows items in a drop-down list.

Getting help

Shortcut Keys	Result
F1	Opens OOo Help dialog. In OOo Help: jumps to first help page of the selected tab.
Shift+F1	Turns cursor into the What's This? question mark. Shows tip for an item underneath the cursor.
Shift+F2	Shows tip for a selected item.
Esc	In OOo Help: goes up one level.

Managing documents

Shortcut Keys	Result
Ctrl+F4 or Alt+F4	Closes the current document. Closes OpenOffice.org when the last open document is closed.
Ctrl+O	Launches Open dialog to open a document.
Ctrl+S	Saves the current document. If you are working on a previously unsaved file, the shortcut launches the Save As dialog.
Ctrl+N	Creates a new document.
Shift+Ctrl+N	Opens the Templates and Documents dialog.
Ctrl+P	Opens the Print dialog to print the document.
Ctrl+Q	Closes ("quits") the application.
Del	In the Save and Open dialogs, deletes the selected files or folders. Items can be retrieved from the Recycle Bin (Garbage Bin).
Shift+Del	In the Save and Open dialogs, deletes the selected files or folders. Items are permanently deleted: they can not be retrieved from the Recycle Bin.
Backspace	In the Save and Open dialogs, shows contents of the current directory's parent folder.

Navigating across OpenOffice.org

Shortcut Keys	Result
F6	Selects next subwindow (for example: Menu bar, Standard toolbar, document view, and so on).
Shift+F6	Selects previous subwindow.
F10	Selects first menu, typically the File menu.
Shift+F10	Opens context menu.

Editing

Shortcut Keys	Result
Ctrl+X	Cuts selected items.
Ctrl+C	Copies selected items.
Ctrl+V	Pastes copied or cut items from the clipboard.
Ctrl+Shift+V	Opens the Paste Special dialog.
Ctrl+A	Selects all.
Ctrl+Z	Undoes last action.
Ctrl+Y	Redoes last action.
Ctrl+Shift+Y	Repeats last command.
Ctrl+F	Opens the Find & Replace dialog.
Ctrl+Shift+F	Searches for the last entered search term.
Ctrl+Shift+R	Refreshes (redraws) the document view.
Ctrl+Shift+I	Shows or hides the cursor in read-only text.

Stopping macros

Shortcut Keys	Result
<i>Shift+Ctrl+Q</i>	Stops a running macro.

Defining keyboard shortcuts

In addition to using the built-in keyboard shortcuts listed in this Appendix, you can define your own. See Chapter 14 (Customizing OpenOffice.org) for instructions.

Further reading

For help with OOo's keyboard shortcuts, or using OOo with a keyboard only, search the application Help using the "shortcut keys" or "accessibility" keywords.

*Appendix **B***
Open Source,
Open Standards,
OpenDocument

Introduction

OpenOffice.org is both a product and an open-source project. If you are new to OOo, its open source development, and the community that produces and supports it, you should read this appendix.

A short history of OpenOffice.org

The OpenOffice.org project began when Sun Microsystems released the source code (“blueprints”) for its StarOffice® software to the open source community on October 13, 2000. OpenOffice.org 1.0, the product, was released on April 30, 2002. On January 26, 2010, Oracle Corporation acquired Sun Microsystems.

Major updates to OpenOffice.org include version 2.0 in October 2005 and version 3.0 in October 2008. Since version 2.0, OpenOffice.org has supported the open standard OASIS OpenDocument as its default file format.

Read more about OpenOffice.org’s history and organization at:
<http://about.openoffice.org/>

The OpenOffice.org community

OpenOffice.org’s Mission Statement is:

“To create, as a community, the leading international office suite that will run on all major platforms and provide access to all functionality and data through open-component based APIs and an XML-based file format.”

The OpenOffice.org project is primarily sponsored by Oracle Corp, which is the primary contributor of code to the project. Our other major corporate contributors include Novell, RedHat, RedFlag CH2000, IBM, and Google. Additionally over 450,000 people from nearly every part of the globe have joined this project with the idea of creating the best possible office suite that all can use. This is the essence of an “open source” community!

With its free software licence and active Native Language Confederation, OpenOffice.org is a key player in the drive to eradicate digital exclusion and preserve minority languages threatened by being on the wrong side of the digital divide.

The OpenOffice.org community invites contributors. Whatever you do best, you can do it for OpenOffice.org. As well as software developers, the Community welcomes translators, artists, technical writers and editors, testers, people offering user support, sales and marketing people, lobbyists, donors... the list is long. The Community operates internationally in all time zones, linked by the internet.

How is OpenOffice.org licensed?

OpenOffice.org is distributed under the Open Source Initiative (OSI) approved Lesser General Public License (LGPL).

The LGPL can be viewed on the OOo website at:
http://www.openoffice.org/licenses/lgpl_license.html

For more general information on OOo’s licensing, please refer to:
<http://www.openoffice.org/license.html>

What is “open source”?

The four essential rights of open-source software are embodied within the Free Software Foundation’s *General Public License* (GPL):

- The right to use the software for any purpose.
- Freedom to redistribute the software for free or for a fee.
- Access to the complete source code of the program (that is, the “blueprints”).
- The right to modify any part of the source, or use portions of it in other programs.

The basic idea behind open source is very simple: When programmers can read, redistribute, and modify the source code for a piece of software, the software evolves. People improve it, people adapt it, people fix bugs.

For more information on Free and Open Source software, visit these websites:

Open Source Initiative (OSI): <http://www.opensource.org>

Free Software Foundation (FSF): <http://www.gnu.org>

What are “open standards”?

An open standard provides a means of doing something that is independent of manufacturer or vendor, thus enabling competing software programs to freely use the same file formats. HTML, XML, and ODF are examples of open standards for documents.

An open standard meets the following requirements:

- It is well documented with the complete specification publically available, either free or at a nominal charge.
- It can be freely copied, distributed and used. The intellectual property of the standard is made irrevocably available on a royalty-free basis.
- It is standardized and maintained in an independent, open forum (also called "standards organization") using an open process.

What is OpenDocument?

OpenDocument (ODF) is an XML-based file format for office documents (text documents, spreadsheets, drawings, presentations and more), developed at OASIS (<http://www.oasis-open.org/who/>), an independent, international standards group.

Unlike other file formats, ODF is an open standard. It is publicly available, royalty-free, and without legal or other restrictions; therefore ODF files are not tied to a specific office suite and anybody can build a program that interprets these files. For this reason ODF is quickly becoming the preferred file format for government agencies, schools and other companies who prefer not to be too dependent on a particular software supplier.

OpenOffice.org by default saves documents in Open Document Format.

OpenOffice.org 3 has adopted version 1.2 of the OpenDocument standard. OOo can also open and save many other file formats; see “File formats OOo can open” on page 367, “File formats OOo can save to” on page 369, and “Exporting to other formats” on page 370.

OpenDocument filename extensions

The most common filename extensions used for OpenDocument documents are:

- *.odt for word processing (text) documents
- *.ods for spreadsheets
- *.odp for presentations
- *.odb for databases
- *.odg for graphics (vector drawings)
- *.odf for formulas (mathematical equations)

Frequently asked questions

May I distribute OOo to anyone?	Yes.
How many computers may I install it on?	As many as you like.
May I sell it?	Yes.
May I use OpenOffice.org in a business?	Yes.
Is OpenOffice available in my language?	OpenOffice.org has been translated (localized) into over 40 languages, so your language probably is supported. Additionally, there are over 70 <i>spelling</i> , <i>hyphenation</i> , and <i>thesaurus</i> dictionaries available for languages, and dialects that do not have a localized program interface. The dictionaries are available from the OpenOffice.org website at: http://lingucomponent.openoffice.org/download_dictionary.html
How can you make it for free?	A large share of the development, and much of the support for the project, is currently supplied or sponsored by Oracle Corp. There are also many other people who work on OOo as volunteers.
What if I need technical support?	Read the section titled "How to get help" in Chapter 1 (Introducing OpenOffice.org).
Who owns the software?	The copyright is shared by Oracle Corp and all the volunteers who have contributed.
Does that mean that they can take away the software?	No. The licenses under which OOo is developed and distributed can never be revoked, so it cannot be taken away.
I am writing a software application. May I use programming code from OpenOffice.org in my program?	You may, within the parameters set in the LGPL. Read the license: http://www.openoffice.org/license.html

Why do I need Java to run OOo? Is it written in Java?	OpenOffice.org is not written in Java; it is written in the C++ language. Java is one of several languages that can be used to extend OOo. The Java JDK/JRE is only required for some features. The most notable one is the HSQLDB relational database engine. Note: Java is available at no cost. If you do not want to use Java, you can still use nearly all of the features of OOo.
How can I contribute to OpenOffice.org?	You can help with the development of OOo in many ways, and you do not need to be a programmer. To start, check out this webpage: http://www.openoffice.org/contributing.html
What's the catch?	There really is none; you can read the licenses here: http://www.openoffice.org/license.html

File formats OOo can open

OpenOffice.org can open a wide variety of file formats in addition to the OpenDocument formats.

Opening text documents

In addition to OpenDocument formats (.odt, .ott, .oth, and .odm), Writer 3 can open the formats used by OOo 1.x (.sxw, .stw, and .sxc) and the following text document formats:

- Microsoft Word 6.0/95/97/2000/XP) (.doc and .dot)
- Microsoft Word 2003 XML (.xml)
- Microsoft Word 2007 XML (.docx, .docm, .dotx, .dotm)
- Microsoft WinWord 5 (.doc)
- WordPerfect Document (.wpd)
- WPS 2000/Office 1.0 (.wps)
- Rich Text Format (.rtf)
- Text CSV (.csv and .txt)
- StarWriter formats (.sdw, .scl, .vor)
- DocBook (.xml)
- Unified Office Format text (.uot, .uof)
- Ichitaro 8/9/10/11 (.jtd and .jtt)
- Hangul WP 97 (.hwp)
- T602 Document (.602, .txt)
- AportisDoc (Palm) (.pdb)
- Pocket Word (.psw)
- HTML Document (.htm, .html)

Most of these file types are automatically detected by OOo, so they can be opened without explicitly selecting the document type in the file picker.

When opening .htm or .html files (used for web pages), OOo customizes Writer for working with these files.

Opening spreadsheets

In addition to OpenDocument formats (.ods and .ots), Calc 3 can open the formats used by OOo 1.x (.sxc and .stc) and the following spreadsheet formats:

- Microsoft Excel 97/2000/XP (.xls, .xlw, and .xlt)
- Microsoft Excel 4.x-5.0/95 (.xls, .xlw, and .xlt)
- Microsoft Excel 2003 XML (.xml)
- Microsoft Excel 2007 XML (.xlsx, .xlsm, .xlts, .xltm)
- Microsoft Excel 2007 binary (.xlsb)
- Lotus 1-2-3 (.wk1, .wks, and .123)
- Data Interchange Format (.dif)
- Rich Text Format (.rtf)
- Text CSV (.csv and .txt)
- StarCalc formats (.sdc and .vor)
- dBASE (.dbf)
- SYLK (.slk)
- Unified Office Format spreadsheet (.uos, .uof)
- HTML Document (.htm and .html files, including Web page queries)
- Pocket Excel (.pxl)
- Quattro Pro 6.0 (.wb2)

Opening presentations

In addition to OpenDocument formats (.odp, .odg, and .otp), Impress 3 can open the formats used by OOo 1.x (.sxi and .sti) and the following presentation formats:

- Microsoft PowerPoint 97/2000/XP (.ppt and .pot)
- Microsoft PowerPoint 2007 (.pptx, .pptm, .potx, .potm)
- StarDraw and StarImpress (.sda, .sdd, .sdp, and .vor)
- Unified Office Format presentation (.uop, .uof)
- CGM - Computer Graphics Metafile (.cgm)
- Portable Document Format (.pdf)

Opening graphic files

In addition to OpenDocument formats (.odg and .otg), Draw 3 can open the formats used by OOo 1.x (.sxd and .std) and the following graphic formats:

BMP	JPEG, JPG	PCX	PSD	SGV	WMF
DXF	MET	PGM	RAS	SVM	XBM
EMF	PBM	PLT	SDA	TGA	XPM
EPS	PCD	PNG	SDD	TIF, TIFF	
GIF	PCT	PPM	SGF	VOR	

Opening formula files

In addition to OpenDocument Formula (.odf) files, Math 3 can open the format used by OOo 1.x (.sxm), StarMath, (.smf), and MathML (.mml) files.

When opening a Word document that contains an embedded equation editor object, if the option for it (MathType to OpenOffice.org Math/ OpenOffice.org to MathType) is checked in **Tools > Options > Load/Save > Microsoft Office**, the object will be automatically converted to an OpenOffice.org Math object.

File formats OOo can save to

Saving in an OpenDocument format guarantees the correct rendering of the file when it is transferred to another person or when the file is re-opened with a later version of OpenOffice.org. It is strongly recommended that you use ODF as default file format. However, you can save files in other formats, if you wish.

Tip When sharing a document that you do not expect or want the recipient to modify, the safest option is to convert the document to PDF. OpenOffice.org provides a very straightforward way to convert documents to PDF. See Chapter 10 (Printing, Exporting, and E-Mailing) in this book.

Saving text documents

In addition to OpenDocument formats (.odt and .ott), Writer 3 can save in these formats:

- OpenOffice.org 1.x Text Document (.sxw)
- OpenOffice.org 1.x Text Document Template (.stw)
- Microsoft Word 6.0, 95, and 97/2000/XP (.doc)
- Microsoft Word 2003 XML (.xml)
- Rich Text Format (.rtf)
- StarWriter 3.0, 4.0, and 5.0 (.sdw)
- StarWriter 3.0, 4.0, and 5.0 Template (.vor)
- Text (.txt)
- Text Encoded (.txt)
- Unified Office Format text (.uot, .uof)
- HTML Document (OpenOffice.org Writer) (.html and .htm)
- DocBook (.xml)
- AportisDoc (Palm) (.pdb)
- Pocket Word (.psw)

Encryption support within the Microsoft Word 97/2000/XP filter allows password protected Microsoft Word documents to be saved.

Note The .rtf format is a common format for transferring text files between applications, but you are likely to experience loss of formatting and images. For this reason, other formats should be used.

Saving spreadsheet files

In addition to OpenDocument formats (.ods and .ots), Calc 3 can save in these formats:

- OpenOffice.org 1.x Spreadsheet (.sxc)
- OpenOffice.org 1.x Spreadsheet Template (.stc)
- Microsoft Excel 97/2000/XP (.xls and .xlw)
- Microsoft Excel 97/2000/XP Template (.xlt)
- Microsoft Excel 5.0 and 95 (.xls and .xlw)
- Microsoft Excel 2003 XML (.xml)
- Data Interchange Format (.dif)
- dBase (.dbf)
- SYLK (.slk)
- Text CSV (.csv and .txt)

StarCalc 3.0, 4.0, and 5.0 formats (.sdc and .vor)
Unified Office Format spreadsheet (.uos)
HTML Document (OpenOffice.org Calc) (.html and .htm)
Pocket Excel (.pxl)

Note The Java Runtime Environment is required to use the mobile device filters for AportisDoc (Palm), Pocket Word, and Pocket Excel.

Saving presentations

In addition to OpenDocument formats (.odp, .otp, and .odg), Impress 3 can save in these formats:

- OpenOffice.org 1.x Presentation (.sxi)
- OpenOffice.org 1.x Presentation Template (.sti)
- Microsoft PowerPoint 97/2000/XP (.ppt)
- Microsoft PowerPoint 97/2000/XP Template (.pot)
- StarDraw, StarImpress (.sda, .sdd, and .vor)
- Unified Office Format presentation (.uop)

Impress can also export to Macromedia Flash (.swf) and any of the graphics formats listed for Draw.

Saving drawings

Draw 3 can only save in the OpenDocument Drawing formats (.odg and .otg), the OpenOffice.org 1.x formats (.sxd and .std) and StarDraw format (.sda, .sdd, and .vor).

However, Draw can also export to BMP, EMF, EPS, GIF, JPEG, MET, PBM, PCT, PGM, PNG, PPM, RAS, SVG, SVM, TIFF, WMF, and XPM.

Writer/Web can save in these formats

- HTML document (.html and .htm), as HTML 4.0 Transitional
- OpenOffice.org 1.0 HTML Template (.stw)
- OpenOffice.org 2.x HTML Template (.oth)
- StarWriter/Web 4.0 and 5.0 (.vor)
- Text (OpenOffice.org Writer/Web) (.txt)
- Text Encoded (OpenOffice.org Writer/Web) (.txt)

Exporting to other formats

OoO uses the term “export” for some file operations involving a change of file type. If you cannot find what you want under **Save As**, look under **Export** as well.

OpenOffice.org can export files to XHTML. In addition, Draw and Impress can export to Adobe Flash (.swf) and a range of image formats.

To export to one of these formats, choose **File > Export**. On the Export dialog, specify a file name for the exported document, then select the required format in the *File format* list and click the **Export** button.

Index

3

3D objects 199

A

accepting or rejecting changes 101
accessibility features 361
accessibility options 44
adding macros from other sources 322
advantages of OpenOffice.org 11
age margins 176
antialiasing screen font 36
appearance options 43
Apply Style list 58
area fill, editing 194
arranging objects 190
arrow styles, customizing 194
arrows 194
Asian language support 52
Asian languages enabled 160
AutoCorrect 54, 88
AutoFormat, Calc 133
AutoInput 124
AutoLayout 159
automatic changes 124
automatic saving 25
AutoRecovery 25, 47
AutoUpdate styles 60

B

background images from Gallery 293
Basic 322
bitmaps 199
BitTorrent 12
book preview 277
booklet printing 274
bookmarks 102
borders, editing 193
brackets (Math) 262
bring forward 190
brochure printing 274
bulleted list 161
Bullets and Numbering dialog 163

C

Calc

AutoFormat 133
editing data 128
Enter key, use of 113
features 106
filtering visible cells 136
formula bar 108
Function Wizard 108
hiding and showing data 134

Navigator 112
outline group controls 135
printing 137
sheet tabs 109
sorting records 136
splitting the screen 121
status bar 109
themes 134
viewing 120
Calc macros 332
callouts 188
CD or DVD of OpenOffice.org 12
cells, in Calc
 formatting 129
 navigating 111
 selecting 115
change tracking 100
changes, undo and redo 28
charts, add to slides 165
check for updates automatically 45
circle, drawing 184
clipboard 37
closing a document 29
closing OpenOffice.org 29
CMYK 178
Color Bar 178
color options 39
color palette 179
color scheme 44
columns, in Calc
 deleting 118
 freezing 120
 inserting 117
 selecting 116
combining objects 198
comma separated values (CSV) 109, 111
command line, starting from 16
comments
 Draw 200
comments, adding 98
Community Forum (user support) 14
complex text layout (CTL) 11, 52
components of OpenOffice.org 10
conditional formatting 134
connectors 186
consultants 14
content boxes (Impress) 157
context menu 193
context menus 20
conversion 199
copy and paste 83
copying object from Gallery 292
create document from template 65
creating a document 23

- cross-fading 197
 - cross-references
 - inserting references 102
 - overview 102
 - CSV file
 - open 110
 - save 111
 - CSV files 109, 111
 - Ctrl-click required to follow hyperlinks 42
 - curves, Draw 185
 - custom dictionary 52
 - Customize dialog 338
 - customizing
 - keyboard shortcuts 352
 - menus 345
 - toolbars 348
 - cut and paste 83
- D**
- dashes 86
 - data editing, Calc
 - changing data in a cell 129
 - removing data from a cell 128
 - replacing all data in a cell 128
 - data entry, Calc
 - dates and times 124
 - fill series 125
 - Fill tool 125
 - numbers 123
 - numbers as text 124
 - selection lists 127
 - sharing content 127
 - speeding up 124
 - text 123
 - validating cell contents 127
 - data source
 - description 202
 - editing 231
 - linking 230
 - registering 230
 - using in OOo documents 232
 - viewing 231
 - data validity 127
 - database
 - AutoValue 209
 - creating 204
 - creating tables 205
 - field types and formats 206
 - list table 213
 - planning 203
 - primary key 205, 208, 210
 - registering 230
 - Report Wizard 246
 - Table Wizard 205
 - tables 205
 - database form
 - activation order 229
 - background 227
 - creating in Design View 229
 - creating using a Wizard 215
 - entering data 235
 - modifying 218
 - subform 216
 - tab order 229
 - database reports
 - creating 245
 - modifying 250
 - static 245
 - database table
 - create using wizard 205
 - dynamic 248
 - joined fields 217
 - relationships 213
 - DataPilot Tools 356
 - date conversion, automatic 124
 - default file format 47
 - default formatting 161, 169
 - default template 70
 - deleting files 25
 - derivative markup (Math) 264
 - Design View (Base)
 - creating a new table 209
 - creating forms 229
 - creating queries 239
 - dictionaries, installing 51
 - dictionary 87
 - different first page 73
 - digital rights management (DRM) 282
 - digital signature 287
 - DIM 326
 - dispatch framework 331
 - dispatch helper 327
 - distorting an image 196
 - divide document into chapters 74
 - dockable window 20
 - document
 - closing 29
 - create from template 65
 - creating 23
 - opening 23
 - starting new 23
 - document status option 34
 - document views 79
 - Documentation Project 14
 - download updates automatically 45
 - downloading OpenOffice.org 12
 - drag and drop 289
 - Draw 199
 - Draw
 - features 175
 - status bar 177
 - toolbars 177
 - workspace 175
 - drawing
 - circle or ellipse 184
 - duplication 196

- Flash export 199
- HTML export 199
- inserting pictures 199
- line 182
- rectangle 183
- save in a foreign format 199
- Drawing Object Properties toolbar 298
- drawing objects
 - 3D objects 199
 - grouping 299
 - grouping and combining 198
 - positioning 199
 - properties 298
- Drawing toolbar 178, 298
- drawing tools 297
- duplication 196
- dynamic gradients 196

E

- E-mail options 53
- e-mailing
 - Mail Merge Wizard 284
 - several recipients 284
 - Writer document as attachment 283
- edit document properties before saving 47
- editing data, Calc 128
- ellipse, drawing 184
- en-dash and em-dash 86
- envelope
 - printing 275
- envelope printing 275
- EPS images in PDF 279
- equation
 - inserting 254
 - numbering 265
- equation editor 254
 - brackets 262
 - derivative markup 264
 - Elements window 255
 - equations over more than one line 262
 - floating window 260
 - font size 261
 - formula layout 262
 - limits to sum/integral 262
 - markup 257
 - matrix markup 263
 - right-click menu 257
- event handling 339
- export directly as PDF 277
- export HTML 50
- exporting
 - Flash 283
 - PDF 277
 - XHTML 283
- extended tips 33
- extension
 - Sun Report Builder 252
- Extension Manager 69, 252

- extensions 341, 354
 - DataPilot Tools 356
 - Solver for Nonlinear Programming (for Calc) 356
- extensions and add-ons
 - sources of 13

F

- fax icon, adding to toolbar 350
- FDF 279
- features
 - Calc 106
 - Draw 175
 - Impress 145
 - Writer 77
- fields 170
- fields
 - bookmarks 102
 - cross-reference 102
- Fields dialog box
 - References tab 103
- file locations 38
- file sharing options 41
- Fill Format 58
- Fill tool, Calc 125
- fill, editing 194
- filtering visible cells, Calc 136
- Flash export 316
- flip an object 195
- floating toolbars 18, 19
- floating window 20
- flowchart symbols 188
- font
 - history 36
 - ignore settings when importing HTML 50
 - options 41
 - preview 36
 - replacement table 41
 - replacements 41
 - sizes for HTML 49
- font resizing (Impress) 160
- Fontwork
 - alignment 302
 - anchoring 304
 - area options 304
 - attributes 303
 - character spacing 303
 - creating an object 300
 - editing an object 301
 - Formatting toolbar 303
 - Gallery 300
 - grouping 305
 - line options 304
 - moving and resizing objects 305
 - positioning options 304
 - same letter heights 302
 - toolbar 300, 302
- Form Wizard 215

- formatting pages 94
- Formatting toolbar 18
- formatting, Calc
 - AutoFormat 133
 - conditional 134
 - themes 134
- formula bar, Calc 108
- formula editor
 - See: equation editor 260
- formula files, opening 367
- formula layout 262
- Free Software Foundation (FSF) 364
- freeform line, Draw 185
- function key shortcuts 361
- Function Wizard, Calc 108

G

- Gallery
 - adding objects 294
 - creating a new theme 295
 - deleting images 295
 - deleting objects 295
 - hide/show 293
 - inserting object as background 293
 - location 295
 - opening 292
 - themes 293
 - views (icon/detailed) 293
- general options 33
- geometric shapes, Draw 187
- gluepoints 186
- GNU/Linux
 - system requirements 12
- gradients 196
- grammar checker 88
- graphic files
 - opening 367
 - saving 369
- graphic styles
 - description 166
 - formatting text 161
- graphics
 - adding from file 289
 - adding to slides 165
 - linking 290
- grid options 180
- grid points 179
- guiding lines 181

H

- handouts (Impress) 150
- header
 - different on right and left pages 74
- headers and footers, Calc 141
- Help Agent 33
- Help system 13
- Help Tips 33

- hidden objects 190
- hiding and showing data, Calc 134
- high contrast 34
- history of OpenOffice.org 363
- HTML compatibility 49
- HTML export 50
- HTML Export Wizard 316
- hyperlinks
 - absolute 307
 - editing 311
 - inserting 308
 - relative 307
 - removing 311
- hyphenation
 - manual 93

I

- icon size and style (user interface) 36
- icons in menus 36
- IDE 325
- ignore font settings when importing HTML 50
- image map 296
- images
 - adding from file 289
 - linking 290
 - scanned 292
- importing files 366
- importing numbers from an HTML page 50
- Impress
 - content boxes 157
 - features 145
 - font resizing 160
 - layout, selecting 156
 - main window 145
 - slide elements, modifying 158
 - slide show, modifying 159
 - starting 145
- Improvement Program 46
- inclination 192
- indents 86
- indexes and bibliographies 99
- Insert Bookmark dialog 103
- Insert Picture dialog 289
- installing and setting up 13
- Internet options 53

J

- Java options 44
- Java Runtime Environment (JRE) 202
- JRE (Java Runtime Environment) 12, 44

K

- KDocker 16
- keyboard shortcuts
 - assigning 352, 361
 - customizing 352

- function keys 361
- loading from a file 354
- resetting to default values 354
- saving to a file 353

keyboard shortcuts (macros) 338

L

- landscape pages 74
- language settings 51
- language support 11
- layout methods 94
- Layout pane 159
- layout, selecting (Impress) 156
- LGPL 365
- libraries of macros 332
- library containers 332
- licensing of OpenOffice.org 363
- limits to sum/integral 262
- Line and Filling toolbar 177
- line properties 193
- line, customizing 194
- line, drawing 182
- lines, editing 193
- linking object from gallery 293
- Linux
 - Quickstarter 16
 - system requirements 12
- list table (database) 213
- load Basic code to edit 48
- load/save options 46
- loading styles 63
- locale settings 51

M

- Mac OS X
 - keystroke differences 30
 - support 14
 - system requirements 12
- macro information 14
- Macro Organizer dialog 335
- macro security options 42
- Macro Selector dialog 337
- Macromedia Flash 316
- macros 322
 - assigning to events 354
 - Calc 332
 - comments 326
 - creating 327
 - DIM 326
 - dispatch framework 331
 - dispatch helper 327
 - downloading 336
 - editing 325
 - event handling 339
 - example 328
 - functions 332
 - IDE 325, 330

- library container 324
- library containers 332
- menu items 338
- module 324
- modules 332
- organization 332
- recording 323
- REM 326
- resources 342
- running 324, 337
- storage 334
- subroutines 326, 332
- variables 326
- viewing 325
- writing 341
- mail merge 100
- Mail Merge Wizard
 - e-mailing Writer document 284
- Mantovani, Paolo 332
- margins 176
- margins (Writer) 97
- Master Pages 166
- master slides 166
- Math formulas, inserting 165
- mathematical equations 254
- mathematical markup 257
- mathematical symbols 255
- matrix markup (Math) 263
- measurement unit 87
- media clips, adding to slides 165
- memory options 34
- menu bar 17
- menus
 - adding commands 347
 - creating 346
 - customizing 345
 - modifying 347
 - modifying entries 347
- Microsoft Office file conversion 48
- Microsoft Windows
 - file associations 15
 - Quickstarter 15
 - system requirements 12
- Microsoft Word 81
- middle mouse button function 37
- mirror copies 196
- mouse positioning 37
- MySQL 202

N

- Native Language Project 14
- navigation
 - cell to cell, in Calc 112
 - sheet to sheet, in Calc 114
- Navigation icons 80
- Navigation toolbar 27, 80
- Navigator 26, 148
- Navigator

- Calc 112
- new document 23
- non-breaking hyphen 86
- non-breaking spaces 86
- nonconsecutive items, selecting 82
- Normal view (Impress) 149
- Notes view (Impress) 149
- numbered list 161
- numbering equations 265
- numbering pages 96

O

- OASIS 12
- objects
 - adjusting size 191
 - arranging 190
 - dynamic movement 191
 - dynamic size modification 191
 - framing 190
 - hidden 190
 - moving 191
 - rotating 192
 - selecting several 191
- ODF format version, saving 47
- ODF plugin (Sun) 81
- Office Assistant (Microsoft) 33
- online update options 45
- OOo Macro Organizer dialog 324
- Open and Save As dialogs 25
- Open Source Initiative (OSI) 363, 364
- Open/Save dialogs 34
- OpenDocument Format 12, 47
- opening a document 23
- OpenOffice.org Basic Macros dialog 323
- Options Bar (Draw) 178
- orientation of page 74
- outline group controls, Calc 135
- outline level 162
- Outline view (Impress) 149
- OXT extension 69

P

- page break, Calc 140
- page layout
 - different first page 73
 - landscape page 74
 - orientation 74
- page layouts 94
- page margins 97
- page numbering 96
- parts of the main window 17
- password protection 24
- password-protect PDF 282
- paste text 83
- pasting unformatted text 161
- path options 38
- PDF

- blank page export 279
- digital rights management (DRM) 282
- embed standard fonts 279
- encrypt 282
- EPS image 279
- export documents to 277
 - form 279
- image compression and resolution 278
- initial view selection 280
- pages to export 278
 - password-protect 282
 - security settings 282
 - tagged 279
 - user interface settings 280
- PDF import 355
- PDF Options dialog 277
- PDF/A-1a 279
- personal data, removing 287
- pictures
 - adding from file 289
 - linking 290
- pictures, add to slides 163
- Pitonyak, Andrew 14
- pixels 175
- polygons, Draw 185
- positioning objects 199
- Powerpoint
 - See: Impress 145
- preloading OOo under Linux/KDE 16
- presentation
 - formatting 156
 - output medium 154
 - running 173
 - slide design 154
 - transition effect 155
 - transitions 155
- presentation styles 166
- Presentation Wizard 153
- presentations
 - saving 369
- primary key 208
- primary key (database) 208
- Print dialog 268
- print file directly 268
- print options
 - general 37
- print preview
 - Calc 277
 - Writer 276
- print ranges, Calc 137
- printer settings 47
- printing
 - black and white on color printer 276
 - booklet 274
 - brochure 274
 - Calc 137, 272
 - envelopes, labels, business cards 275
 - general options 269

- grayscale on color printer 276
 - handouts 274
 - headers and footers, Calc 141
 - Impress and Draw 273
 - multiple pages per sheet 270
 - notes (Impress) 274
 - page break, Calc 140
 - page order, details, scale, in Calc 138
 - page orientation 269
 - rows or columns on every page 139
 - selecting what to print 271
 - Writer 271
 - Professional Template Pack extension 356
- Q**
- queries (database)
 - aliases 243
 - creating using a Wizard 237
 - creating using Design View 239
 - joined fields 217
 - search conditions 239
 - Query Wizard (database) 237
 - Quickstarter 15
 - enabling 34
 - quotation marks 124
- R**
- raster graphics 199
 - rectangle, drawing 183
 - redlines 100
 - redo change 28
 - regular expressions 84
 - relationships (database) 213
 - REM 326
 - remove manual formatting 169
 - remove personal information on saving 42
 - removing personal data 287
 - renaming files 25
 - replacement table (font) 41
 - Report Builder extension 356
 - Report Wizard (database) 246
 - revision marks 100
 - RGB 178
 - right to left (RTL) layout 11
 - right-click (context) menus 20
 - rotating an object 192
 - rows, in Calc
 - deleting 118
 - freezing 120
 - inserting 117
 - selecting 116
 - rulers (Draw) 176
- S**
- save as
 - web page 311
 - save AutoRecovery information 47
 - save original Basic code 48
 - save relative URLs 47
 - saving files 24
 - scaling factor (user interface) 35
 - scanner 292
 - screen font antialiasing 36
 - security 24
 - security options 41
 - selecting
 - nonconsecutive items 82
 - vertical block of text 83
 - selecting objects 190
 - selection clipboard 37
 - selection lists, Calc 127
 - selection modes 189
 - selection, in Calc
 - cells 115
 - columns 116
 - rows 116
 - sheets 116
 - send backward 190
 - send document as e-mail 284
 - sequence of styles, automatic 75
 - setup options 32
 - shadows 195
 - shapes, Draw 187
 - shared extension 355
 - sheet tabs, Calc 109
 - sheets, in Calc
 - deleting 119
 - inserting 118
 - renaming 119
 - selecting 116
 - shortcut keys 358
 - size optimization 47
 - slanting an object 192
 - Slide Design dialog 168
 - slide elements, modifying 158
 - slide master 166
 - adding text 169
 - apply 167
 - author information 171
 - Creating 167
 - description 166
 - loading additional 168
 - modifying 169
 - slide show
 - automatically advance 172
 - See: presentation 145
 - transitions 172
 - slide show, modifying 159
 - Slide Sorter view (Impress) 151
 - slides
 - adding charts 165
 - adding comments 171
 - adding graphics, spreadsheets, other objects 165
 - adding media clips 165

- adding pictures 163
 - adding tables 164
 - adding text 158
 - layouts 156
 - master 166
 - modifying 158
 - rename 153
 - Slides pane (Impress) 146
 - snap functions 179
 - Snap to grid 179
 - Solaris
 - system requirements 12
 - Solver for Nonlinear Programming (for Calc) 356
 - sort order (database fields) 238
 - sorting records, Calc 136
 - special characters 85, 89
 - spelling checker 87
 - spelling options 52
 - spreadsheet
 - using as data source 230
 - spreadsheets
 - adding to slides 165
 - cell reference 111
 - definition 106
 - navigate 111
 - opening 367
 - saving 368
 - saving as CSV 111
 - Standard toolbar 18
 - StarBasic 322
 - Start Center 23
 - starting a new document 23
 - starting OpenOffice.org 14
 - status bar 21
 - Calc 109
 - Draw 177
 - Impress 148
 - Writer 77
 - Style dialog 60, 61
 - styles 195
 - Apply Style list 58
 - assigning to shortcut keys 352
 - AutoUpdate 60
 - changing using Style dialog 60
 - creating by dragging and dropping 62
 - creating from selection 61
 - creating new 61
 - creating using Style dialog 61
 - custom 61
 - defining a sequence 75
 - deleting 64
 - description 56, 166
 - Fill Format 58
 - formatting text 161
 - graphic styles 166
 - linking 61
 - loading from template or document 63
 - modifying 59
 - presentation styles 166
 - types supported 56
 - updating from a selection 60
 - Styles and Formatting window 57
 - SUB 326
 - subroutines 332
 - subroutines in macros 326
 - Sun Microsystems 363
 - Sun Report Builder 252
 - support 13
 - system font (user interface) 36
- T**
- tab stops 86
 - table of contents, automated 99
 - Table Wizard (database) 205
 - tables, add to slides 164
 - Tasks pane (Impress) 147
 - tear-off toolbars 18
 - template
 - associate with document 71
 - create document from 65
 - create from document 66
 - create using wizard 67
 - deleting 73
 - description 56
 - editing 68
 - exporting 73
 - Extension Manager 69
 - folders 72
 - update document styles from 68
 - Template Changer extension 356
 - Template Management dialog 62
 - templates
 - importing 73
 - text
 - bulleted or numbered list 161
 - default formatting 161
 - formatting pasted text 161
 - outline level 162
 - pasting 160
 - text boundaries (show/hide) 44
 - text box
 - AutoLayout 159, 162
 - creating 159
 - moving 173
 - vertical alignment of text 160
 - text box tool 159
 - text documents
 - opening 366
 - Text Formatting toolbar 161
 - text in Draw 185
 - theme
 - deleting 295
 - themes 293
 - themes (Gallery) 295
 - toolbar icons (macros) 338

- toolbars 148
 - adding commands 349
 - choosing icons for commands 350
 - Color Bar 178
 - creating 349
 - customizing 20
 - displaying or hiding 18
 - Draw 177
 - Drawing 178
 - Fontwork 300
 - Line and Filling toolbar 177
 - moving 19
 - Options Bar (Draw) 178
 - overview 18
 - show or hide icons 20
- tooltips 33, 157
- track changes 100
- transparency 195, 196
- two-digit years 34
- typing errors, autocorrect 124

U

- undo change 28
- undoing groups 198
- unformatted text, pasting 161
- ungrouping 198
- unit of measurement 176
- unsaved changes flag 78
- URL Recognition 308
- user data options 32
- user guides 14
- user interface options 35
- user interface, parts of 22
- user-specific settings 46

V

- validating cell contents, Calc 127
- variables in macros 326
- VBA properties load/save options 48
- vector graphics 175

- vertical alignment of text 160
- vertical block of text, select 83
- view options 35

W

- Web Layout 311
- web page export
 - Calc spreadsheets 316
 - Impress presentations 316
 - Web wizard (Writer) 312
 - Writer documents 312
- wildcards 84
- windows, dockable/floating 20
- wizard
 - form (database) 215
 - presentation 153
 - query (database) 237
 - report (database) 246
 - table (database) 205
 - web 312
- workspace
 - Draw 175
- workspace views (Impress) 149
- Writer
 - document views 79
 - features 77
 - Navigation icons 80
 - Navigation toolbar 80
 - status bar 77
 - workspace 77
 - zoom 79, 80

X

- XML 47

Y

- year (two digits) 34

Z

- zoom 79, 80